



www.midway.com

FEBRUARY 2000
16-15909-101



Operation Manual for

4-PLAYER, 25" VIDEO GAME CONVERSION KIT

Dual Product with Player-Selectable Games

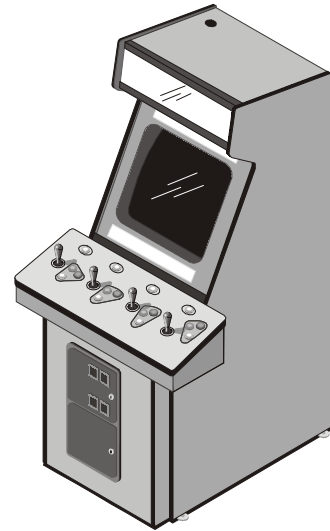



- 1-Assembly
- 2-Operation
- 3-NFL Audits
- 4-NBA Audits
- 5-Wiring
- 6-Troubleshooting



NBA SHOWTIME GOLD EDITION / NFL BLITZ 2000 GOLD EDITION CONVERSION KIT

CHAPTER ONE

ASSEMBLY

	<p>WARNING: Use of non-Midway parts or circuit modifications may cause serious injury or equipment damage! Use only Midway authorized parts.</p> <p>For safety and reliability, don't substitute parts or modify Midway products. Substitute parts or modifications may void EMC directive or FCC type acceptance.</p>
	<p>NOTICE: The term VGM refers to the video game machine.</p>

SAFETY INSTRUCTIONS

The following safety instructions apply to operators and service personnel. Read these instructions before preparing your video game machine (VGM) for play. Other safety instructions appear throughout this manual.





DEFINITIONS OF SAFETY TERMS









DANGER indicates an imminent hazard. If you fail to avoid this hazard, it *will* cause death or serious injury.

WARNING indicates a potential hazard. If you fail to avoid this hazard, it *could* cause death or serious injury.

CAUTION indicates a potential hazard. If you fail to avoid this hazard, it *may* cause minor or moderate injury. CAUTION also alerts you about unsafe practices.

NOTICE indicates information of special importance.

	<p>WARNING: DISCONNECT POWER. Always turn the power <i>off</i> and unplug the VGM before attempting service or adjustments. Installing or repairing PC boards with power on can damage components and void the warranty. Be sure that you securely install ground wires.</p>
	<p>WARNING: GROUNDING. Avoid electrical shocks! Don't plug in a VGM until you have inspected and properly grounded it. Only plug this VGM into a grounded, three-wire outlet. Don't use a "cheater" plug, or cut off the ground pin on the line cord.</p>
	<p>WARNING: SALVAGED PARTS. Kit completion requires salvaging parts from old VGMs. Salvaged parts must operate perfectly. Otherwise, the converted VGM can't perform properly or safely. Before you attempt conversion, repair circuit board malfunctions and cabinet damage.</p>
	<p>WARNING: HANDLE FLUORESCENT TUBE AND CRT WITH CARE. If you drop a fluorescent tube or CRT and it breaks, it will implode! Shattered glass can fly eight feet or more from the implosion.</p>
	<p>WARNING: HAZARD TO EPILEPTICS. A small portion of the population has a condition that may cause epileptic seizures. Affected persons experience seizures while watching some television pictures or playing certain video games. People who have not had seizures may still have an undetected epileptic condition.</p> <p>If anyone in your family has experienced epilepsy symptoms (e.g., seizures or loss of awareness), consult your physician before using video games.</p> <p>While children play video games, a parent should observe. Be alert to the following symptoms: Dizziness, altered vision, eye or muscle twitching, involuntary movements, loss of awareness, disorientation, or convulsions. If you or your child experience these symptoms, <i>discontinue use immediately</i> and consult your physician.</p>

	<p>CAUTION: HANDLING ELECTRONIC DEVICES. This kit's electronic components are <i>sensitive to static electricity</i>. Before handling electronics, observe the following precautions...</p> <ul style="list-style-type: none"> • Before servicing electronics, turn off AC power to the VGM. • Before handling electronics, discharge static electricity on your body. Touch the power supply's safety ground stud before touching electronics. • Store electronic assemblies in an anti-static area. Use an anti-static bag to store the CPU board assembly. After you install the new unit, reuse the same bag to protect the old CPU board. • Don't remove or connect electronics when cabinet power is on. Otherwise, you'll damage VGM electronics and void your warranty.
	<p>CAUTION: USE PROPER FUSE. Avoid electrical shock! Replacement fuses must be of the same type as those they replace. Fuse voltage and current ratings must match ratings on the original fuse.</p>
	<p>CAUTION: WIRING. This kit uses as much of the existing wiring as possible. Avoid improper operation! After you complete the conversion, but before applying power, check the wiring. Verify that the wiring matches the diagrams.</p>
	<p>CAUTION: TAKE CARE WHEN SHIPPING HARD DISKS. The hard disk drive must be packed in an anti-static bag. When shipping the drive for repair or replacement, pack it in an approved container (P/N 08-8068). Never stack or drop hard disk drives.</p>
	<p>NOTICE: POWER SUPPLY. Be sure that your old VGM's power supply can produce these voltages and currents: +5VDC at 6A, -5VDC at 1A and +12VDC at 4A. Meter these operating voltages before you disconnect the old electronics from the VGM. Power supply voltages must measure within +/-5% under load. Your power supply must be FCC approved.</p>
	<p>NOTICE: MONITOR TYPE. This kit isn't compatible with X-Y monitors. Suitable monitors have horizontally mounted CRTs and raster electronics. Only use a monitor with inputs for RGB video and composite, positive or negative sync.</p>
	<p>NOTICE: COIN MECHANISMS. Clean your VGM's coin mechanisms. Also test coin mechanisms with appropriate currency. Servicing these mechanisms is crucial to your VGM's earning potential.</p>
	<p>NOTICE: COIN METERS. This kit doesn't include coin meters. For your convenience, the factory provides meter wiring information. You may use salvaged meters if they operate satisfactorily.</p>
	<p>NOTICE: 2-PLAYER CONTROL PANELS. You can use this kit to convert VGMs with 2-player control panels. A DIP-switch setting allows two-player operation. See DIP SWITCH TESTS in chapters 3 and 4.</p>

PRODUCT SPECIFICATIONS

Equipment Characteristics

Video Display Monitor

- Standard or medium resolution, RGB
- Composite, positive or negative sync
- DIP switch U12-2 sets resolution
- SIO Jumper J2 sets sync polarity

Audio System

Digital Stereo Sound for
2 Coaxial, Full-Range
Speakers

Currency Acceptors

- 4 Mechanical Coin Switch Inputs
- Dollar Bill Validator Input
- Electronic Coin Acceptor Input

VGM Characteristics

Player Variables

- 1 to 4 players per game
- High Score Recognition
- Parental Advisory Disclosure: "Suitable for all Ages"

Operator Variables

Coinage, Game Options,
Difficulty, Volume, Audits,
Statistics

Diagnostics, Audits, Adjustments

- Automatic, Power-Up Self-Test
- Manual, Multi-Level Menu System



NOTICE: FCC COMPLIANCE. Installation of this kit into any existing product does not guarantee compliance with FCC requirements. You are solely responsible for FCC compliance for installations in other products. You must remove any existing FCC compliance label. Don't install a new label on the converted product until you have verified FCC compliance.

INSPECT KIT 15909

Kit 15909 includes joysticks, buttons and cables to convert a player control panel. Unpack the materials from the carton and check for obvious signs of damage. Use this checklist to be sure the kit is complete. You must supply the remainder of the materials required for this conversion.

Item	Part #	Qty	Item	Part #	Qty
ARTWORK			COMPONENTS, MAJOR		
<input type="checkbox"/> Artwork, Backlit Marquee	31-3586	1	<input type="checkbox"/> Board, Auxiliary Adapter	04-12652	1
<input type="checkbox"/> Decal, Bottom Bezel Instrs	31-3484	1	<input type="checkbox"/> Board, CPU	A-23702	1
<input type="checkbox"/> Decal, Cabinet Side Panel	31-3476	2	<input type="checkbox"/> Bd, I-40 Joystick Adapter	04-11089	1
<input type="checkbox"/> Decal, NBA Hologram	31-1768	1	<input type="checkbox"/> Board, Sound I/O	A-23704	1
<input type="checkbox"/> Decal, Player Panel Add-Ons	31-3481.1	1	<input type="checkbox"/> Bracket, Hard Drive	01-15029	1
<input type="checkbox"/> Decal, Player Panel Hsg	31-3479-1	2	<input type="checkbox"/> Drive, Hard (Assy)	A-23703	1
<input type="checkbox"/> Decal, Player Pnl Hsg-Front	31-3479-3	1	<input type="checkbox"/> Electronics (w / Video PCB)	A-23205	1
<input type="checkbox"/> Decal, Player Pnl Wallpaper	31-3480.1	1	<input type="checkbox"/> Joystick	A-21939-1	4
<input type="checkbox"/> Decal, Side Panel Logo	31-3587	2	DOCUMENTS		
<input type="checkbox"/> Decal, Top Bezel Instructions	31-3483	1	<input type="checkbox"/> Card, VGM Registration	16-10650	1
<input type="checkbox"/> Header, Cardboard	31-3482.1	1	<input type="checkbox"/> Label, Epilepsy Warning	16-9922.1	1
BUTTONS			<input type="checkbox"/> Label, FBI Warning	16-8587-825	1
<input type="checkbox"/> Button, Blue, Long Shaft	20-10209-3	4	<input type="checkbox"/> Manual, Kit	16-15909-101	1
<input type="checkbox"/> Button, Orange, Long Shaft	20-10209-7	4	<input type="checkbox"/> Sheet, Caution, Elec Dev	16-10077	1
<input type="checkbox"/> Button, Red, Long Shaft	20-10209-1	4	<input type="checkbox"/> Template, Player panel	16-10830	1
<input type="checkbox"/> Button, White, Long Shaft	20-10209-2	4	MISCELLANEOUS		
CABLES			<input type="checkbox"/> Bead, 1-1/4" Ferrite	5556-13956-00	1
<input type="checkbox"/> Cable, Fan and Disk	H-22900.2	1	<input type="checkbox"/> Cage, EMI	04-12655	1
<input type="checkbox"/> Cable, 20-Pin Ribbon	5795-10937-09	1	<input type="checkbox"/> Clamp, 1/4" Cable	03-7655-4	6
<input type="checkbox"/> Cable, 40-Pin Ribbon	5795-16308-12	1	<input type="checkbox"/> Container, Hard Drive Ship	08-8068	1
<input type="checkbox"/> Cable, Pod Extension	H-22948	1	<input type="checkbox"/> Cover, Plastic Ctl Panel	03-9961	1
<input type="checkbox"/> Cable, Shielded Video	20-10493	1	<input type="checkbox"/> Grommet, 7" Plastic	RM-37-11	1
<input type="checkbox"/> Harness, Player panel	H-22785	1	<input type="checkbox"/> Spacer, 1/4" PCB Mounting	03-8338-1	6
<input type="checkbox"/> Harness, Main Wire (JAMMA)	H-23208	1	<input type="checkbox"/> Spacer, Wood	11-1274	4
			<input type="checkbox"/> Wrench, T-20, Tamper-Res	20-9620	1

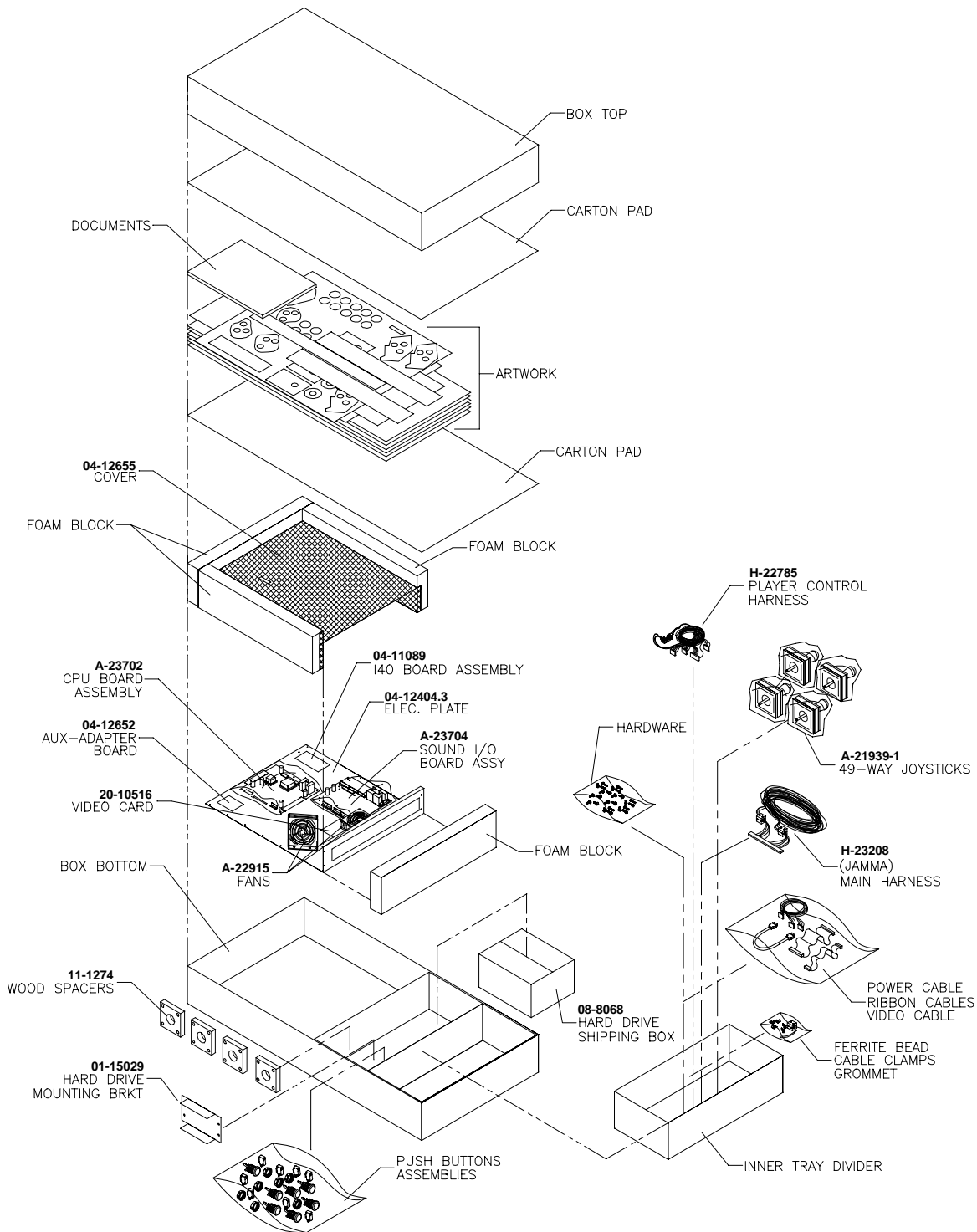

**PACKAGING DETAILS FOR KIT 15909
(NO PLAYER CONTROL PANEL)**

	<p>NOTICE: PLAYER CONTROL PANEL. Kit 15909 doesn't include a player control panel. Instead, you must convert or build a player panel. Midway Games offers a plug-and-play panel kit, including the housing. Your kit 15909 is 100 percent compatible with the optional player panel. If you want to order the optional panel, ask for kit 45494.</p>
---	---

YOU'LL NEED THESE TOOLS AND SUPPLIES...

- Black, semi-gloss paint
- Electric drill and wood bit set
- Screwdrivers
- Liquid Soap (dish detergent)
- Grease pencil or marker
- 180 grit sandpaper or electrical sander
- Wood filler (putty, board, etc.)
- Electrical tape
- Small screw assortment
- Nut drivers or socket wrench set
- Razor knife
- Squeegee or soft sponge
- Soldering iron and solder
- Wire cutters
- Pliers
- Hole saw or equivalent

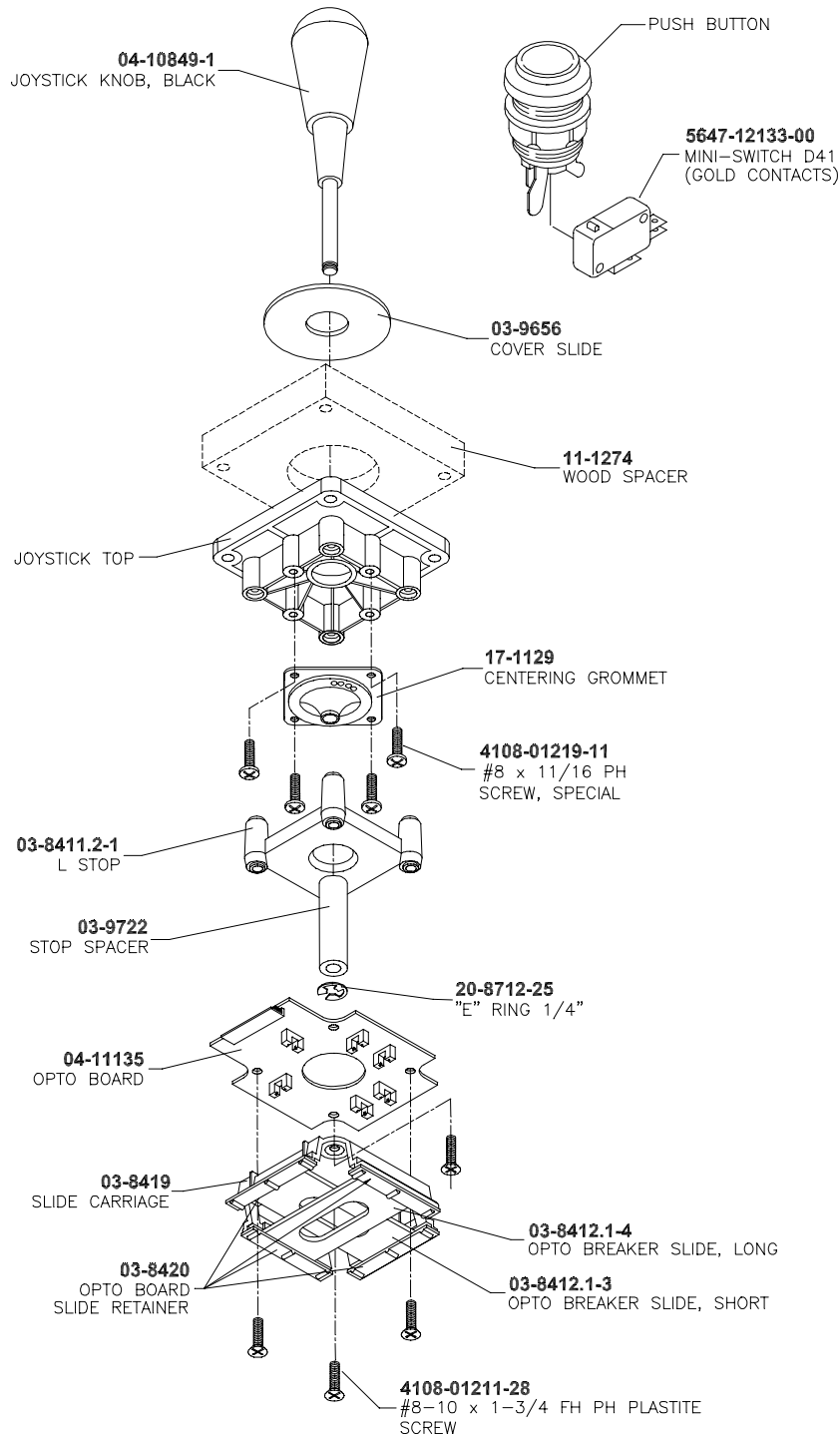

JOYSTICK ASSEMBLY

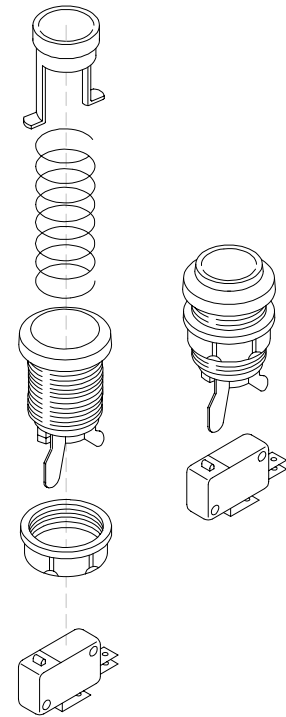

PUSHBUTTON ASSEMBLY

BLITZ 2000 PUSHBUTTON TABLE

	SWITCH PUSHBUTTON	RED	B-PASS/CHANGE PLAYER
20-10209-1	SWITCH PUSHBUTTON	WHITE	TURBO
20-10209-2	SWITCH PUSHBUTTON	BLUE	A: JUMP/TACKLE
20-10209-3	SWITCH PUSHBUTTON	ORANGE	START

SHOWTIME PUSHBUTTON TABLE

	SWITCH PUSHBUTTON	RED	B: SHOOT/BLOCK
20-10209-1	SWITCH PUSHBUTTON <td>WHITE</td> <td>TURBO</td>	WHITE	TURBO
20-10209-2	SWITCH PUSHBUTTON <td>BLUE</td> <td>A: PASS/STEAL</td>	BLUE	A: PASS/STEAL
20-10209-3	SWITCH PUSHBUTTON <td>ORANGE</td> <td>START</td>	ORANGE	START

CONVERTING A TYPICAL VIDEO GAME CABINET

PREPARE THE CABINET

- [] 1. Verify operation of the old VGM before making changes to the cabinet. Pay special attention to components that you will reuse. (Power supply, video monitor, currency acceptors, wiring harnesses, cabinet locks, lighted marquee, etc.)
- [] 2. Switch off power to the VGM. Disconnect the line cord from the AC power. Clear the work area. Cover or protect non-wood items. (Marquee, monitor, coin door, brackets, line cord, etc.)
- [] 3. Remove old decals and artwork from the cabinet sides. Clean off glue residue. Fill gouges, unused holes, etc. with quick-hardening wood putty. Sand smooth and remove dust.
- [] 4. Evenly cover the entire cabinet with black paint. Allow the paint to dry completely before continuing.
- [] 5. Pencil a line roughly at the top of the previous graphic. Lightly moisten the cabinet with soapy water. Remove the backing and apply the decal. Start at the top and work down. Working outward from the center of the decal, smooth down the decal. Take care to squeeze out air bubbles. If you can't remove a bubble, pop it with a knife or pin. Allow at least 12 hours for the adhesive in the decal to set.

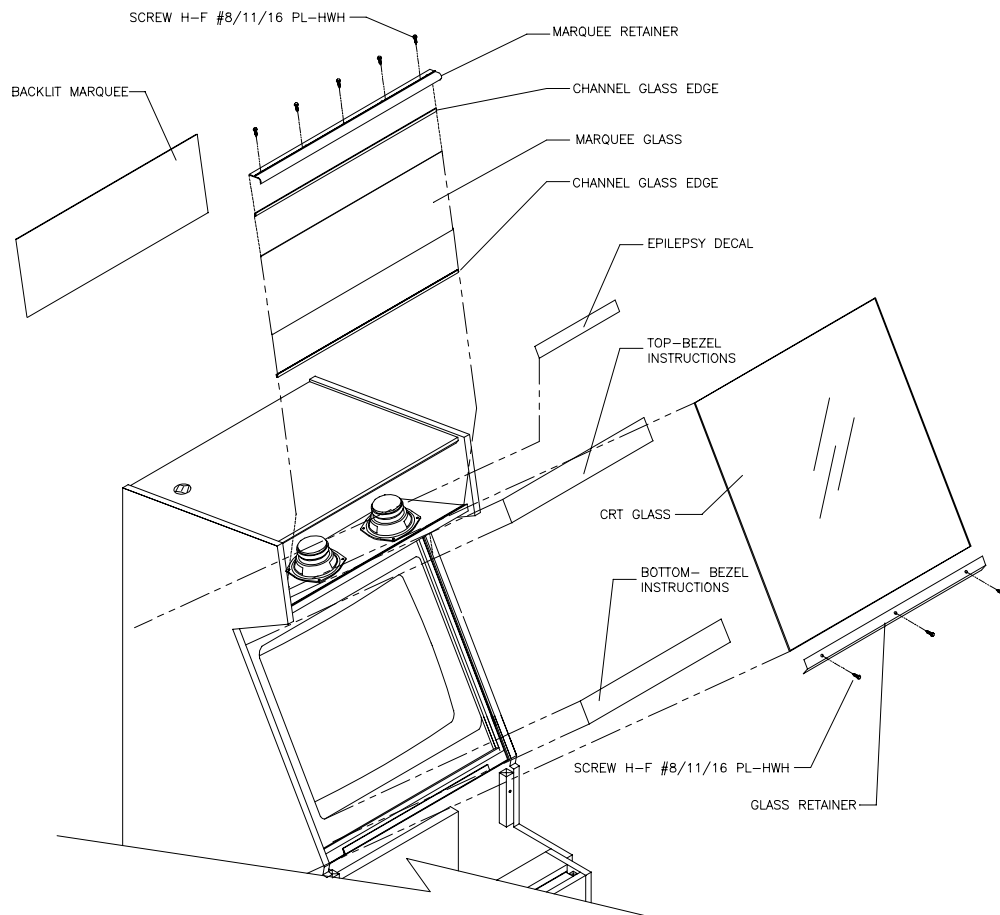

- [] 6. Remove the backlit marquee artwork from the old marquee on the VGM cabinet. Check the fluorescent tube. If you find cracks or darkened ends, replace the tube. Clean the inside of the marquee. Use the old marquee artwork as a guide, and trim the new artwork to size. Deburr the

edges of the new marquee artwork. Crease the new artwork as necessary to match the shape of the old artwork. Clean the new marquee artwork and the marquee glass. Install the new artwork on the VGM.

- [] 7. Remove the viewing glass and set it in a safe place. Clean the CRT and monitor bezel. Locate the player moves and game-play instruction decals. Apply them to the top and bottom-front of the monitor bezel. Find the epilepsy warning label. Place this label on the top-front of the monitor bezel. Be sure that decals and labels don't obstruct the viewing area *Don't reinstall the viewing glass yet.*
- [] 8. Remove and save the screws at the top and sides of the rear door. Unlock the rear door, and then lift it off of the cabinet and set it aside. Cover the VGM electronics. Use a vacuum cleaner to remove dirt or debris from inside the cabinet.
- [] 9. Compare your player control panel to the player panel template. If the player panel and template match, then skip to the next step. Otherwise, proceed with the rest of this step. Locate the player panel latches or fasteners. Free the player panel from its operating position. Separate the control panel's earth ground (green) wiring from other control panel wiring. Cut cable ties as necessary to achieve this separation. Leave the earth ground (green) wiring in place. Disconnect and remove the remaining old wiring from the CPU Board and player controls. Remove the player panel and housing from the VGM cabinet. Save the mounting brackets and hardware for reinstallation later.
- [] 10. Some cabinets have speakers on the player panel or other removable pieces of the cabinet. If you must disconnect speaker harnesses, mark the polarity and functions of the wires. Incorrectly phased speakers can cause weak low frequencies or a thin, hollow sound quality.

	<p>NOTICE: FCC COMPLIANCE. Installation of this kit into any existing product does not guarantee compliance with FCC requirements. You are solely responsible for FCC compliance for installations in other products. You must remove any existing FCC compliance label. Don't install a new label on the converted product until you have verified FCC compliance.</p>
---	--

- [] 11. Unfold the cardboard marquee header from your kit. Make sure that the triangular brace supports the middle of the marquee.
- [] 12. Install the marquee header on top of the marquee. You must supply the four wood screws necessary for fastening down the marquee.

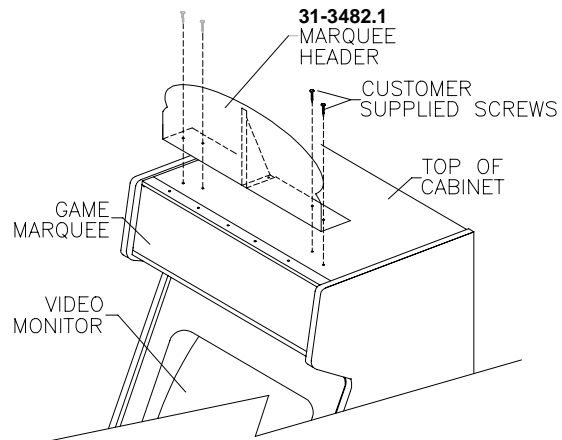

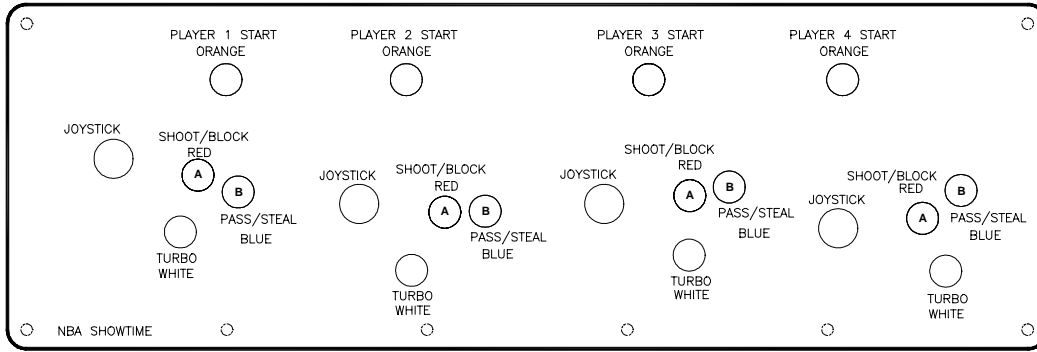

PLAYER PANEL BUTTONS

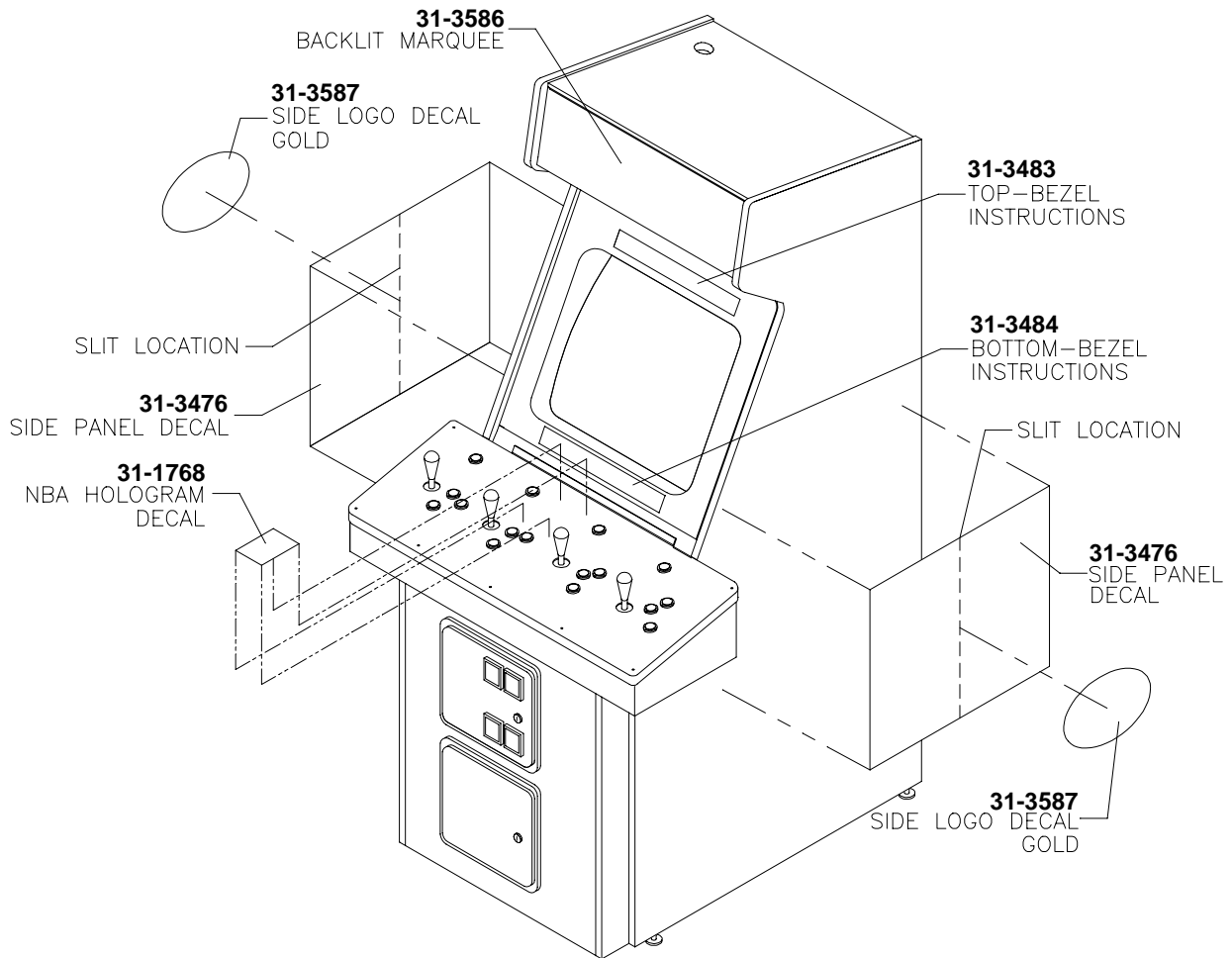

TYPICAL DECAL MOUNTING DETAILS

INSTALL PLAYER CONTROLS

	<p>NOTICE: This isn't an actual-size drawing. Use the template to help you position and drill mounting holes. Don't attempt to substitute this drawing for the template.</p>
---	---

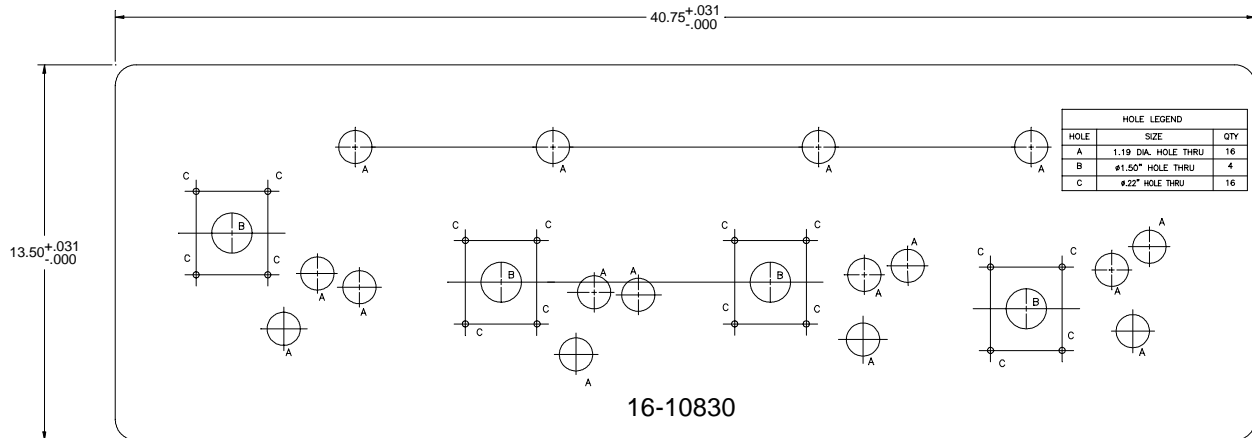

PLAYER PANEL TEMPLATE 16-10830

- [] 1. If you're assembling both kit 15909 and optional player panel 45494, skip to Step 19. If you're assembling just kit 15909, proceed with the next step.
- [] 2. Locate and unfold the player panel template. Temporarily stack newspapers, books, magazines, etc., on the template. The weight will flatten the template sufficiently for use.
- [] 3. If necessary, remove buttons, joysticks and T-nuts from the old player panel and cabinet front. Remove the panel covering and artwork from the previous game. Remove and save hinges or mounting brackets.
- [] 4. If necessary, fill the old player panel holes with wood, putty, glue, etc. Allow adequate time for materials to dry. Sand or file the player panel to a flat surface on both sides.

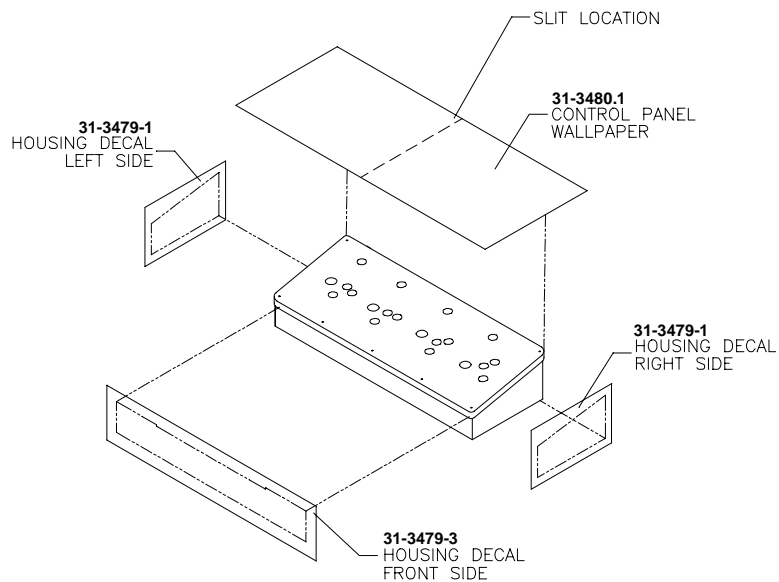

- [] 5. Place the player panel face down on top of the clear plastic cover. Center the player panel. Mark the outside shape of the panel on the cover. Also mark hole locations. Remove the player panel and set it aside. Cut and deburr holes for player panel buttons. Trim the cover to panel shape.
- [] 6. Lightly moisten the cabinet with soapy water. Remove the backing from the wallpaper decal. Apply the decal to the player panel. Start at the top and work down. After you've positioned the decal, smooth it outwards. Take care to squeeze out air bubbles. If you can't remove a bubble, pop it with a knife or pin. Then smooth the bubble down. Allow the decal adhesive to set.
- [] 7. Use a sharp knife to trim edges and cut holes for player panel buttons. Position control decals next to the appropriate hole locations. Allow the decal adhesive to set.
- [] 8. Install the NBA hologram decal on the player panel.
- [] 9. Install the plastic cover over the decals and panel. Attach the cover and deburr the edges. Group player controls by color (orange, red, blue and white). Joysticks are black. You must disassemble controls for panel mounting.
- [] 10. Separate the switch from the orange PLAYER 1 START (left START) button. Bend the large prong away from the switch just enough to slide the switch off the housing. Unscrew the nut from the housing. Insert the button housing through its hole from the player panel's front. Screw the nut finger-tight onto the switch housing from the panel back. Rotate the housing so that switch terminals face the panel center. Tighten nuts firmly. Snap the switch back onto the housing.
- [] 11. Repeat the previous step with the other three start buttons.
- [] 12. Consult this chapter's illustration *Player Panel Buttons*. Install the other buttons.
- [] 13. Tighten the pushbutton nuts firmly. Replace player panel components and hardware that you removed earlier.
- [] 14. Measure the thickness of the player panel. If it is less than ½ inch (13 mm), use wooden spacers to recess the joysticks below the surface. Thicker player panels don't require wooden spacers.
- [] 15. Install a carriage bolt in each small hole near each joystick opening. If the player panel is thin, place wood spacers over the carriage bolts. The spacers correct joystick-mounting depth.
- [] 16. Invert one joystick. Remove the "E"-ring from the shaft. Remove the handle and plastic ring (large washer) from the joystick base. *The bushings must remain in the base.* The top of the joystick base fits against the bottom of the player panel (or spacer, if used). Orient the connector toward the START buttons. Align mounting holes. Attach the base to the player panel bottom. Slide the plastic ring around the shaft so that the rough side is beside the knob handle. Slide the shaft through the player panel and base. Replace the "E"-ring. Repeat this step for the remaining joysticks.
- [] 17. Locate the I-40 Joystick Interface Board. Insert a plastic spacer into the bottom of a mounting hole. Press the spacer to seat it fully. Repeat this procedure until all spacers attach to the board.
- [] 18. Place the I-40 Interface Board inside the player panel housing. See the housing drawing. Position the I-40 Board near the housing's right side. Assure that controls don't hit components when you open and close the panel. Leave space above and beside board connectors for mating connectors. Mount the I-40 Board with a screw through each plastic spacer.
- [] 19. The completed player panel should now resemble the illustration below. Install the modified panel housing onto the cabinet with the original mounting hardware. Firmly tighten fasteners.
- [] 20. Install the side and front player panel decals onto the player panel housing.

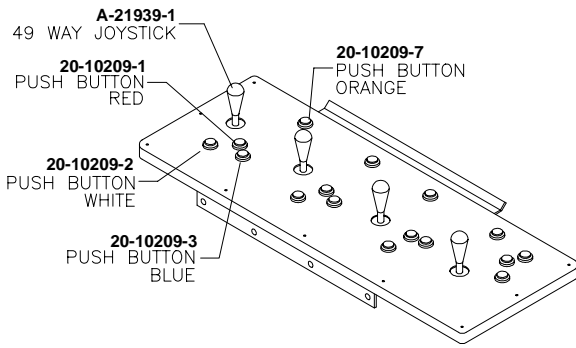

TYPICAL MODIFIED PLAYER PANEL

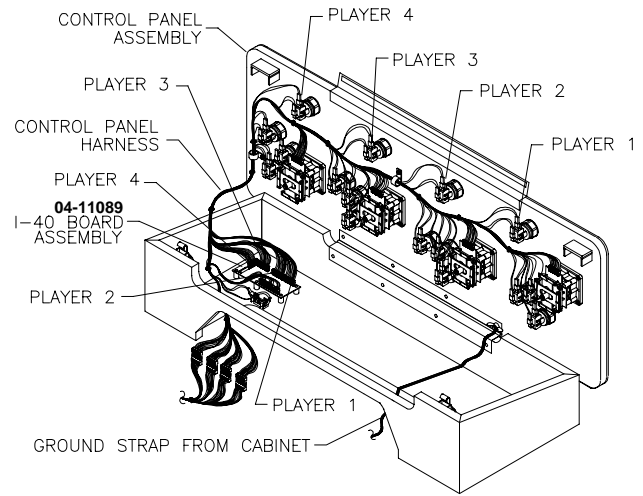



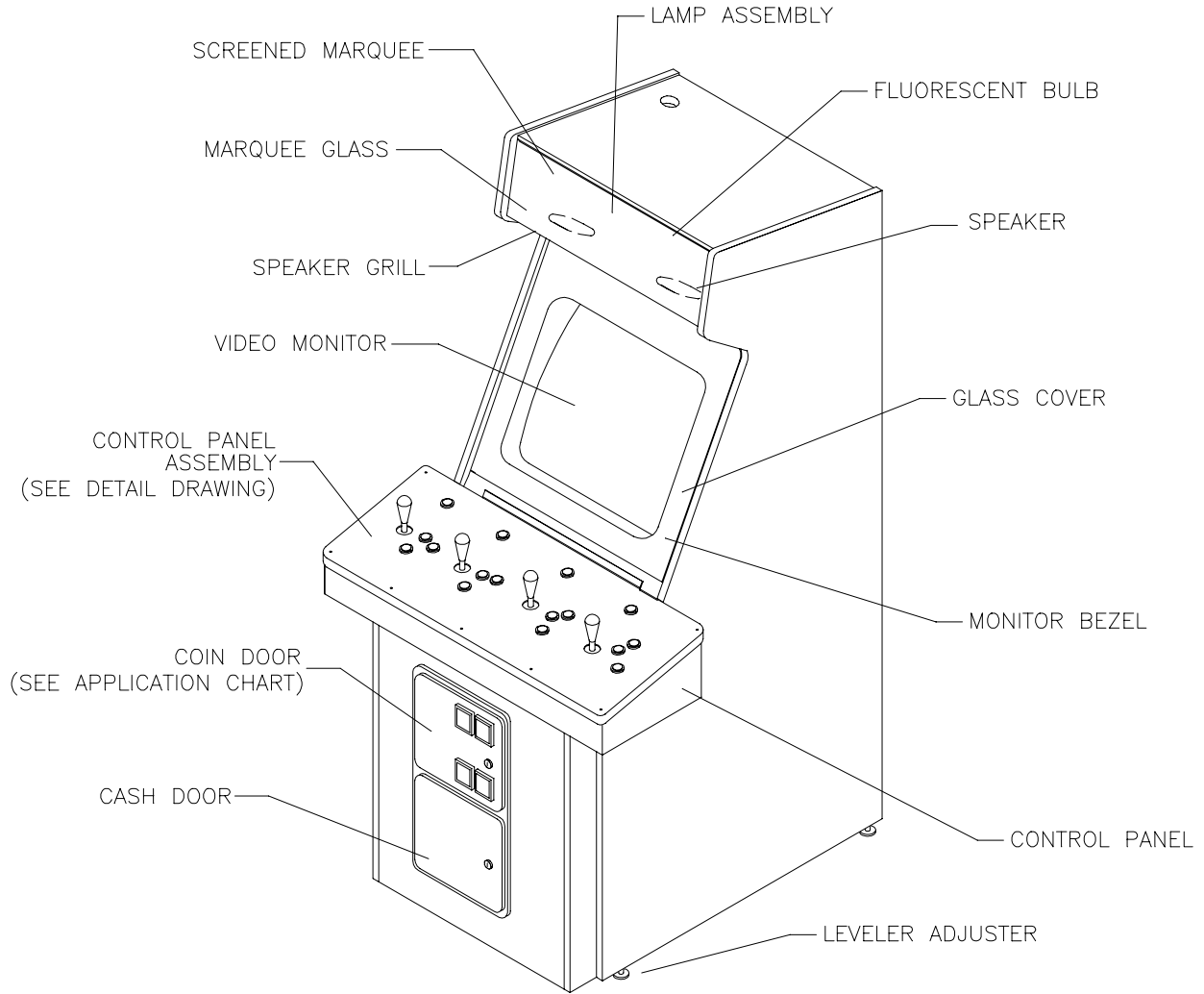

TYPICAL PLAYER PANEL HOUSING



TYPICAL COMPLETED CABINET

INSTALL ELECTRONICS TRAY COMPONENTS

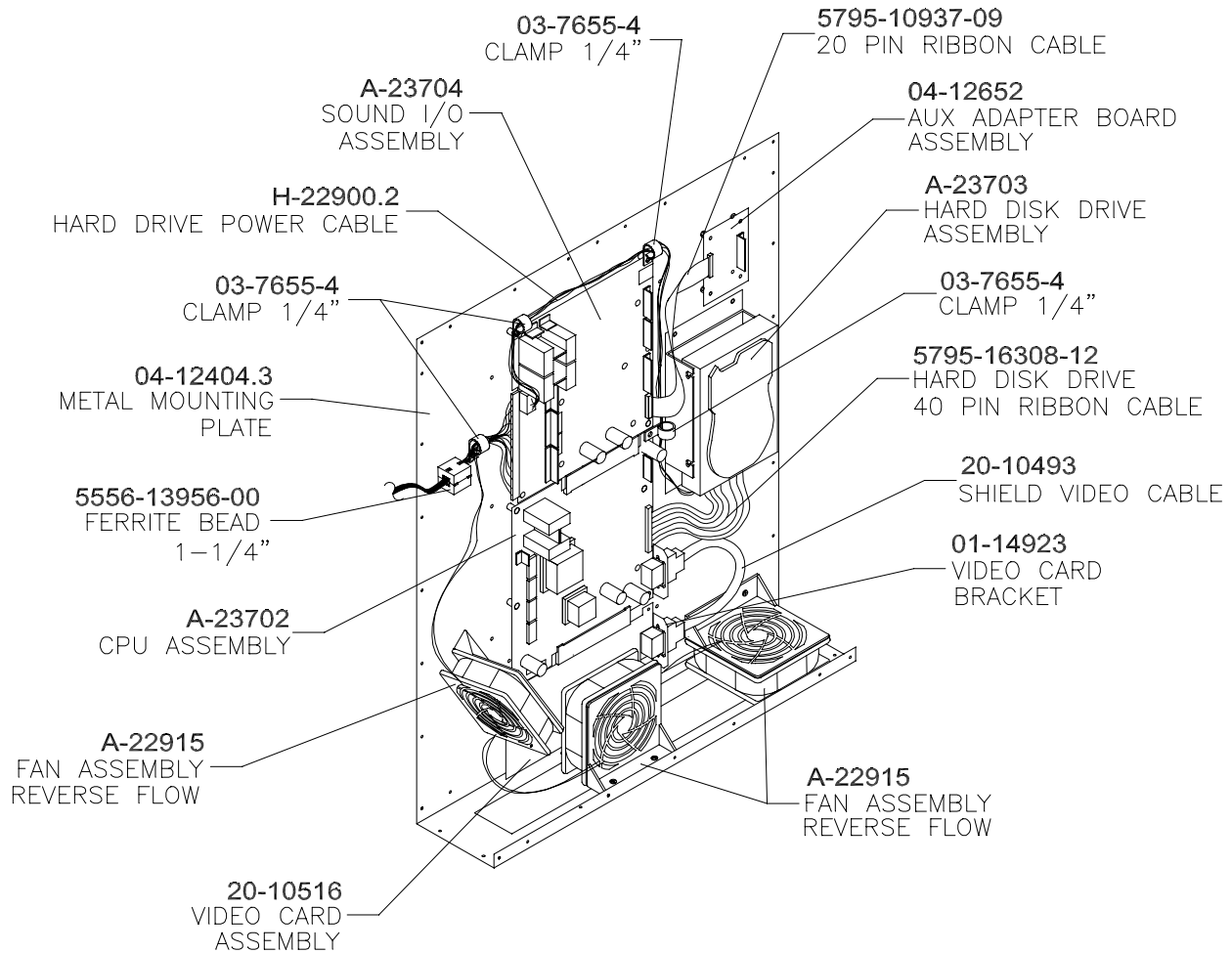

	CAUTION: Board set electronic components are static sensitive. Prepare an anti-static work area. Ground yourself before removing circuit boards from their protective shipping materials.
	WARNING: Don't connect cables to the circuit boards or power supply when the power is on. Otherwise, you'll damage VGM electronics and void your warranty.
	CAUTION: Hard disk drives are fragile. Don't stack or drop hard disk drives.
	NOTICE: If your monitor requires positive sync, remove jumper J2 on the SIO Board.

- [] 1. Switch off power and disconnect the line cord from AC line voltage. Disconnect cables from the VGM's printed circuit boards. Remove the old printed circuit boards. If your VGM includes a disk drive or drive mounting plates, remove them. Store these items in anti-static packaging from new components.
- [] 2. You can attach the new electronics directly to a cabinet wall or to a separate panel. If the cabinet doesn't have a suitable surface, install a wood piece approximately 8 inches (20 cm) from the rear door.
- [] 3. Unpack the Electronics Tray and place it on a flat work surface. Take note of the Banshee Video Board, which is bolted to the Electronics Tray. The Banshee Video Board is a small, rectangular circuit card. You'll notice a steel header bracket at one of the Video Board's short ends.
- [] 4. Unpack the three, unmounted circuit boards and position them over the Electronics Tray.
- [] 5. Find the CPU Board. The CPU Board is a roughly square board, and has a seven-segment LED display. In the center of the CPU Board are two large, heat-sinked ICs. Position the CPU Board's 15-pin connector beside the Video Board's header bracket. Then plug the CPU Board into the Banshee Video Board.
- [] 6. Find the Sound I/O Board. The Sound I/O Board is a roughly square board, with a JAMMA connector on one side. This board also includes the VGM's DIP-switch banks. Plug the Sound I/O Board into the CPU Board.
- [] 7. Align circuit board mounting holes with standoff posts on the Electronics Tray. Mount the circuit boards to standoffs with 8-32 Phillips pan head screws.
- [] 8. Find the Auxiliary Output Adapter Board. This is a small, rectangular board, with two connectors. It doesn't plug into any of the other boards. Notice the ribbon connector on the side of the Auxiliary Output Adapter Board. Position this connector close to the Sound I/O Board. Screw the Auxiliary Output Adapter Board to standoff posts on the Electronics Tray.
- [] 9. The factory installed the fans for you. They reside beneath the board set and hard drive. If you mounted the boards vertically, the fans should blow upward, across the electronics. You'll want to check the airflow later. (For now, check fan markings that indicate airflow direction.)



TYPICAL ELECTRONICS LAYOUT

WIRE THE CIRCUIT BOARDS

	<p>NOTICE: You must install the Main (JAMMA) Wiring Harness supplied with this conversion kit. This VGM's 49-way joysticks require wires and circuits not found in earlier VGMs. If the connectors in your cabinet don't fit onto the CPU Board or wire colors don't match the JAMMA Chart, contact your authorized distributor for assistance.</p>
	<p>CAUTION: Insulate unused wires within the JAMMA cable, especially red, yellow, orange and black power wires. Secure unused connectors away from the CPU Board and its cover.</p>
	<p>CAUTION: ATTACH CONNECTORS PROPERLY. Be sure that printed circuit board (PCB) connectors mate properly. If connectors don't slip on easily, don't force them. A reversed connector may damage your VGM and void the warranty. Connector keys allow a connector to fit only one set of pins on a board.</p>

- [] 1. Connect the shielded video cable between Video Board jack J4 and CPU Board plug P4. Your video monitor requires either positive or negative sync. If necessary, add or remove the video sync jumper at SIO Board jumper block J2. The default mode is positive sync (no jumper between pins 1 and 2). For negative sync, jump pins 1 and 2.

- [] 2. Locate disk drive power cable H-22900.2. (This cable has separate wires and plastic connectors at each end). Attach the power cable to SIO connector P3 (near a large heatsink). Mate the plug and jack. Press them firmly to seat contacts. *The connector is keyed. Don't use excessive force.*
- [] 3. The disk drive power cable includes three plugs for the fans. Connect these plugs to the fans.
- [] 4. Secure hard disk drive and fan cables with three cable clamps from the kit. Attach the cable clamps to standoffs at three corners of the SIO Board. Use the board's mounting screws to fasten the clamps to the standoffs: Position the first clamp near the SIO Board's large heatsink. Position the second clamp directly across from the first, near the Auxiliary Adapter Board. Position the third clamp near the hard drive.
- [] 5. Locate the hard drive data cable, a ribbon cable. Orient the data cable connector over CPU Board plug P5. Align the connector's striped edge with Pin 1, near the video connector. (The stripe may be red, blue or another color.) Mate the connector halves. Press them firmly to seat contacts.
- [] 6. Connect the Main Harness to the SIO Board edge (JAMMA). This cable has wires for the coin door, control buttons, I-40 Joystick Interface Board, speakers, video monitor, power supply, and so forth. Insulate and secure all extra wires (unused slam tilt switch, coin meter, etc.).
- [] 7. Search through the Main Harness for the Player 4 and Player 3 cables. Player 4 has gray wires with stripes. Player 3 has blue wires with colored stripes. Connect Player 3's plug to SIO Board jack P14, and Player 4's plug to P7.
- [] 8. Find the coin door power connector. (Look for the black, red and orange wire bundle.) Attach this connector to plug P23 on the SIO Board.
- [] 9. Search through the Main Harness for the six-pin monitor connector. Plug this into your monitor.
- [] 10. Connect the Main Harness to the Aux Out Adapter Board at connector P1.
- [] 11. Connect the 20-pin ribbon cable to the Aux Out Adapter Board at jack P1. Connect the other end of this ribbon cable to SIO Board at jack P15.

MOUNT THE ELECTRONICS TRAY

- [] 1. Set the electronics against the wood panel. Use the tray as a template to mark mounting hole locations. *(If you plan to mount the electronics vertically: Orient the Electronics Tray so that its long edges are vertical and large heatsinks are at the top.)*
- [] 2. If necessary, drill pilot holes for mounting screws. Use sheet metal screws to secure the Electronics Tray to the cabinet. Attach the tray with only four corner screws. *Don't use excessive force.*
- [] 3. Remove the hard drive from its package. Locate the hard drive mounting bracket. Set the drive in the mounting bracket. Align screw holes and install the 6-32 screws with spring washers.
- [] 4. Orient the drive and drive mounting bracket over threaded studs on the Electronics Tray. Align the holes. Attach the bracket with 8-32 KEPS® nuts.
- [] 5. Temporarily hold the perforated metal cover over the electronics. Be certain that cover mounting holes are accessible. Relocate the plate if necessary. Don't install the metal cover yet.

- [] 6. Locate the data and power connectors on the hard drive. Connect the free end of the hard drive power cable to the disk drive. Mate the plug and jack. Press them firmly to seat contacts. *Don't use excessive force.*
- [] 7. Position the striped edge of the hard drive data cable by the power cable. Attach the cable to the drive's data connector. *The data connector is keyed. Don't use excessive force.*

WIRE THE CABINET

Kit 15909, Without Optional Player Panel 45494...

	<p>NOTICE: This player panel uses 49-way joysticks and an I-40 Joystick Interface Board (input-multiplexer circuit). The VGM requires additional wiring harnesses. These items must be field installed to customize the unit for each kit.</p>
---	---

- [] 1. Locate cable H-22785. This cable includes a fuse for protection of the Joystick Interface that mounts in the player panel housing. This cable must be mounted in the player panel housing. Remove the fuse from the fuse holder and retain it for reuse.
- [] 2. Open the player panel. Place the fuse holder beside the wall of the player panel housing. Attach the fuse holder with a #6 short sheet metal screw (not supplied). Reinstall the fuse in the holder.
- [] 3. Connect cable H-22785 between the I-40 Joystick Interface Board and each joystick. Player 1 wire colors are mostly white, Player 2 wires are violet, Player 3 are blue, and Player four are gray. The I-40 connectors are User 0 (Player 1), User 1 (Player 2), User 2 (Player 3), and User 3 (Player 4). *This VGM doesn't use the User 4 connector.* Consult the Cabinet Wiring Diagram, and connect the cable wires to the switches. Secure wiring with a cable clamp and cable ties.
- [] 4. Connect the Common terminal of each button on the panel with a black wire. Join this wire with the black wire from the cable. Connect the Normally Open terminals to each of the switch wires.

All Kits...

	<p>CAUTION: <i>Prevent electrical fires and power supply damage!</i> When attaching JAMMA pigtails to the power supply, maintain fusing from the original VGM wiring. If a line was fused before, then the new line must have a fuse, too.</p>
---	---

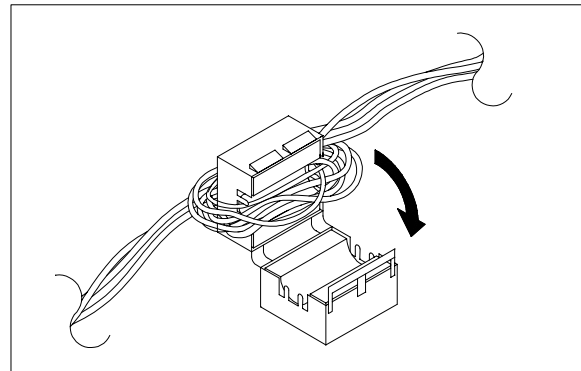

- [] 5. See the Cabinet Wiring Diagram. Connect your power supply to the pigtail leads from the Main (JAMMA) Harness. Red wires connect to +5 volts DC. Yellow wires connect to -5 volts DC. Orange wires connect to +12 volts DC. Black wires connect to ground. If necessary, solder the appropriate connector onto the Main Harness, or design your own adapter. Thoroughly insulate soldered or pigtail connections.
- [] 6. Connect cabinet speakers to the pigtail leads from the Main Harness. Red-gray and brown-gray wires connect to the left speaker. Red-white and brown-white wires connect to the right speaker. To eliminate serious distortion, be sure to phase the speakers properly. With either speaker, connect the red wire to the speaker's positive phase terminal. On many speakers, a dot marks this terminal. To test for positive phase, connect a 1.5-volt battery to the speaker and observe the cone. If the cone moves inward, reverse the battery leads. When the cone moves outward, the positive battery lead connects to the positive phase terminal. Mark this terminal with a dot.

- [] 7. Locate the square, split ferrite bead. The factory has installed one ferrite bead around DC power conductors (solid color heavy gauge wires with pin numbers 1-6 or A-F). A second bead encircles player panel conductors (striped color lighter gauge wires). Install the remaining ferrite beads on the video monitor cable and power supply wires. The video cable bead should trap a loop of cable. Place all beads as close to the JAMMA connector as possible. Then close and lock each bead. Assure that no wires are pinched or caught in the latches.



LOOP VIDEO CABLE THROUGH BEAD

- [] 8. Locate the central power ground point for the cabinet. (Ground wires are usually green. Some may have a yellow stripe.) Assure that the previously installed ground wire from the controller port still connects to the same central point. Reconnect ground wires that you loosened or removed in previous steps (monitor, player panel, coin door, etc.).
- [] 9. Find the electronics cover. Install plastic grommet RM-37-11 over the aperture where cables pass through the cover. This grommet part is a tough, plastic sleeve. It protects your fingers and your cables from the cover's sharp, metal edge.
- [] 10. Locate the sheet metal screws from the kit. If necessary, drill pilot holes for the screws. Install the electronics cover. Insert a screw in every mounting hole. Fasten the Electronics Tray to the cabinet. Tighten the screws firmly. Take care not to pinch wires.
- [] 11. Connect your coin door switches to the pigtail leads from the Main Harness. If your cabinet doesn't include diagnostic switches, you may add them now. (These momentary switches speed up routine service calls.) Refer to the cabinet wiring diagram in Chapter Five. Thoroughly insulate soldered or pigtail connections.

	<p>NOTICE: You can order the diagnostic switch bracket and switches as Midway part number A-19542-1.</p>
	<p>NOTICE: IF YOU'RE INSTALLING A BILL VALIDATOR, set the validator for 1 pulse per dollar. Also adjust the pulse width setting. The validator must generate pulses with these timing parameters: 50ms on (minimum) and 50ms off (minimum).</p>

CHECK YOUR CABLING JOB

- [] 1. Carefully inspect cables between peripherals and the board set. The main wiring harness edge connector (JAMMA) attaches to the SIO Board.
- [] 2. The hard drive data (ribbon) cable connects the hard drive to CPU Board jack P5. Be sure that you've also connected the hard drive power connector to power cable H-22900.2. The other end of this cable should connect to the SIO Board at P3.

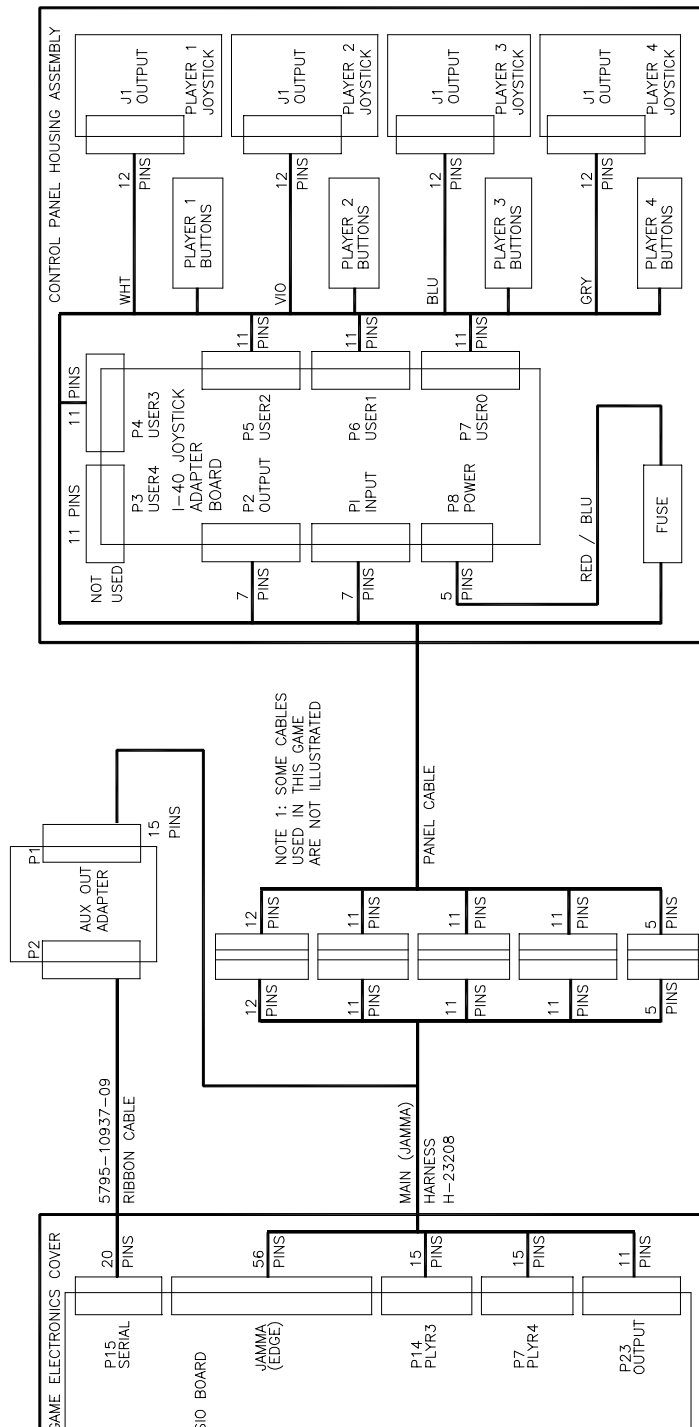

CABLE BLOCK DIAGRAM

- [] 3. The Player 3 connector (blue wires) attaches to the SIO Board at P14. The Player 4 connector (gray wires) attaches to the SIO Board at P7. This connector links SIO circuits to the I-40 Joystick Interface Board.

- [] 4. Open the player control panel and locate player panel cable H-22785. This cable connects to the joysticks, switches, fuses, and I-40 adapter. Connectors designated Player 1 (mostly white wire colors) and Player 2 (violet) mate with the same color cables from the main harness. Player 3 (blue) and Player 4 (gray) connectors mate with the same color cables from the main harness. Power connectors (red and black) from player panel fuses mate with the same color cable from the main harness.

- [] 5. Check wiring to the Auxiliary Output Adapter Board against instructions in *Wire the Cabinet*. The block diagram below also depicts this wiring.

- [] 6. A shielded cable should join Video Board jack J4 and CPU Board plug P4.

- [] 7. Have you connected the monitor to the Main Harness?

- [] 8. Assure that you've reinstalled all fuses. Check that you've set DIP switches correctly (Chapter Three).

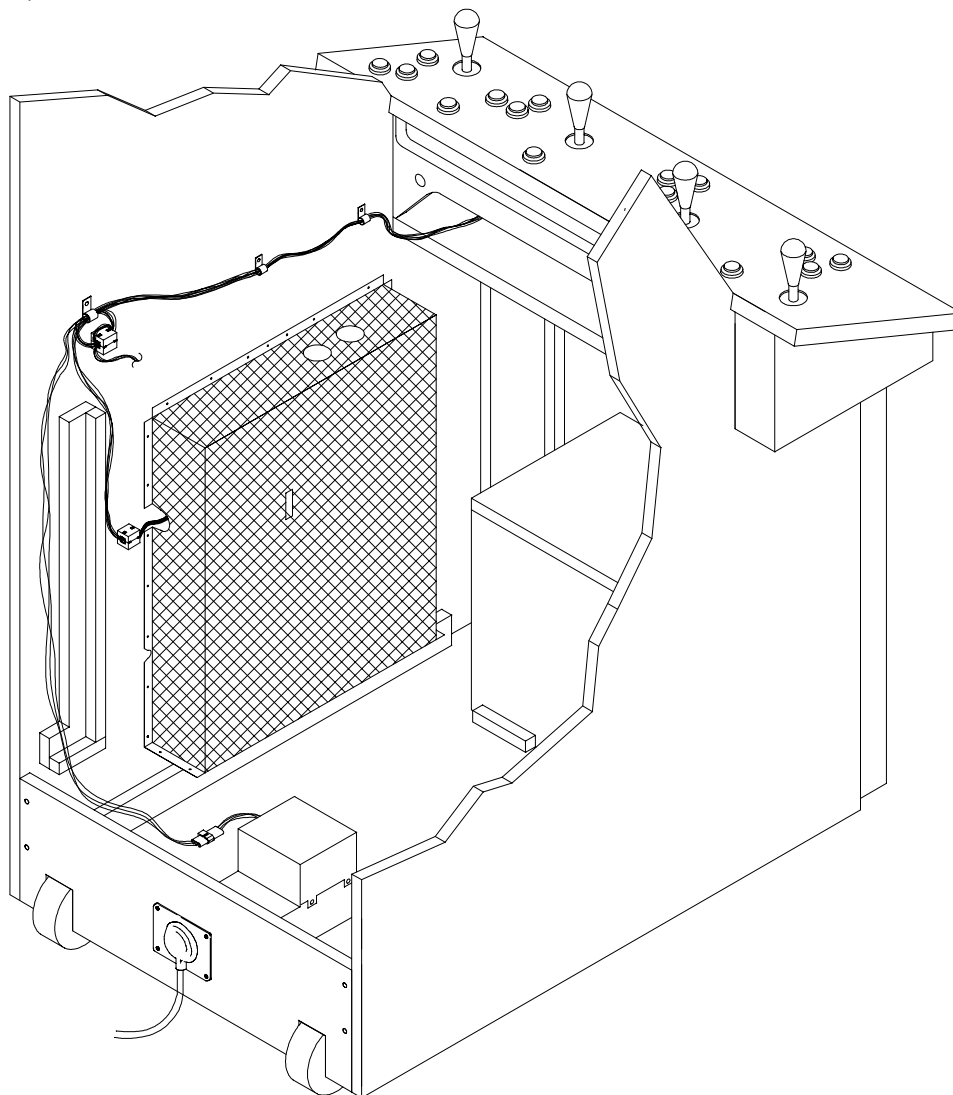

TYPICAL REAR VIEW OF COMPLETED CABINET

POWER UP AND TEST THE VGM

- [] 1. Plug the power cord into the AC line and turn on the VGM. Circuit board indicators should illuminate.
- [] 2. The VGM system loads the program and begins self-diagnostics. If the system doesn't find any errors, the system automatically enters its Attract Mode. If problems occur, check wiring and troubleshoot the machine.
- [] 3. Unlock and open the coin door. Press and hold the TEST MODE button until the Menu System appears on the screen.
- [] 4. Select MONITOR SETUP at the Diagnostics Menu. Confirm proper video display operation and adjust the monitor as necessary.
- [] 5. Select DISK TESTS at the Diagnostics Menu. Run all the tests in order to verify correct drive operation.
- [] 6. Select SWITCH TESTS at the Diagnostics Menu. Check to be sure that all control switches work.
- [] 7. Select DIP-SWITCH TESTS at the Diagnostics Menu. Verify that all switches are set to optimum positions for this VGM.
- [] 8. Select SPEAKER TEST at the Diagnostics Menu. Verify operation of audio system components.
- [] 9. Select EXIT at the Main Menu. The system should enter Game-Over Mode. Open the coin door and press the SERVICE CREDITS button to allow game play. Choose a joystick and press the START button to begin play. Listen to the audio while playing the game. Note sound irregularities (phase problems, no low frequencies, mono audio from stereo speakers, etc.). Check the wiring harness for internal shorts or strapped connections.
- [] 10. Close and lock the coin door. Replace the rear cabinet door. Allow the system to operate for several hours before attempting any game changes.
- [] 11. After you confirm proper operation, submit the VGM for FCC or other agency approval.



CAUTION: You are solely responsible, and Midway has no responsibility for FCC compliance of installed kits. Don't install an FCC compliance label on the product until the FCC acknowledges compliance.

NBA SHOWTIME GOLD EDITION / NFL BLITZ 2000 GOLD EDITION CONVERSION KIT

CHAPTER TWO

OPERATION



NOTICE: The term VGM refers to the video game machine.

VIDEO GAME MACHINE (VGM) OPERATION

STARTING UP

Whenever you turn on the machine or restore power, the system executes boot ROM code. The boot ROM contains self-diagnostic tests. These tests automatically verify and report the condition of the disk drive and other hardware. The screen is blank during these tests. If the hardware fails a test, the system displays an error message. The message appears for 30 seconds or until someone presses a button.

- If nobody presses a button, the system quickly completes tests, and then loads game software.
- To skip boot ROM tests and activate the Menu System, press and hold the TEST MODE button. You'll find this button behind the coin door.

Having passed power-up tests, the VGM computer enters Attract Mode. Attract Mode consists of typical game scenes and sounds, alternating with high scores. Attract Mode continues until game play commences.

Players insert currency or tokens to start the game. Pressing a START determines which player receives the credit. The VGM computer asks the players which game that they want to play: *NBA Showtime Gold Edition* or *NFL Blitz 2000 Gold Edition*. Players request one or the other via player panel controls. Then players select a team. The VGM computer associates one team with the Player-1 and Player-2 joysticks. The Player-3 and Player-4 joysticks assume control of the opposing team. Play begins after a countdown period. Play progresses like a real-life football or basketball game. At Game-Over Mode, players may choose to begin again. If players choose not to continue, then the VGM computer returns to Attract Mode.

GAME RULES FOR *NFL BLITZ 2000 GOLD EDITION*

INSTRUCTIONS

Play instructions appear on the information panel over and under the video monitor.

ONE TO FOUR PLAYERS

Players may enter their names for future reference. Then they select teams and run the first play. Players may choose an offensive or defensive play. Additional game information appears on the screen as needed. Team statistics appear at the end of each quarter.

CONTROLLING CHARACTERS

The joystick and action buttons control characters on the field. The joysticks respond to different amounts of deflection as well as direction.

GAME ACTION

Standard league football rules apply, with two exceptions: First downs require 30 yards, and teams only have seven active players. Game adjustment settings determine game length and speed.

The player view of the action changes automatically whenever a better camera angle becomes available. The game sounds include announcer comments and crowd noises.

SCORING

Touchdowns and goals score points, just as in real football games.

PLAY SELECTION FOR *NFL BLITZ 2000 GOLD EDITION*

STANDARD PLAYS

The player may select any of the offensive or defensive plays in the game. Players can choose from pages of standard plays loaded into the game. Use the indicated pushbuttons to view and select any play.

CUSTOM PLAYS

Players may choose to create their own offensive plays rather than depend on the standard plays in the game. Players can design and name their plays using the CREATE PLAY feature, then store these plays for future use. These custom plays become available on an additional page of game plays.

PLAYER CONTROLS FOR *NFL BLITZ 2000 GOLD EDITION*

The player controls are used to maneuver the team members and attack or defend against adversaries.

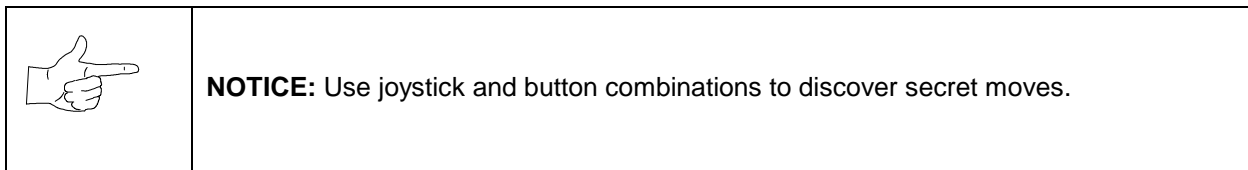

- **START.** This button allows players to begin or continue play. Use PLAYER 1 START and PLAYER 2 START to begin a two-player game. START has no game action or service function.
- **JUMP / TACKLE.** This button lifts the offensive team member up or causes the defensive player to tackle opponents. Use this same button to create plays or select menu items during service.
- **PASS / CHANGE PLAYER.** This button activates offensive throws. The defense move switches active control to another teammate. Use this same button to create plays or select menu items during service.
- **TURBO.** The TURBO button gives any active character an extra burst of power or speed. Use this same button to create plays or select menu items during service.
- **JOYSTICK.** Each player has a joystick to control the movements of one on-screen character at a time. Use the joystick to create plays or select menu items during service.

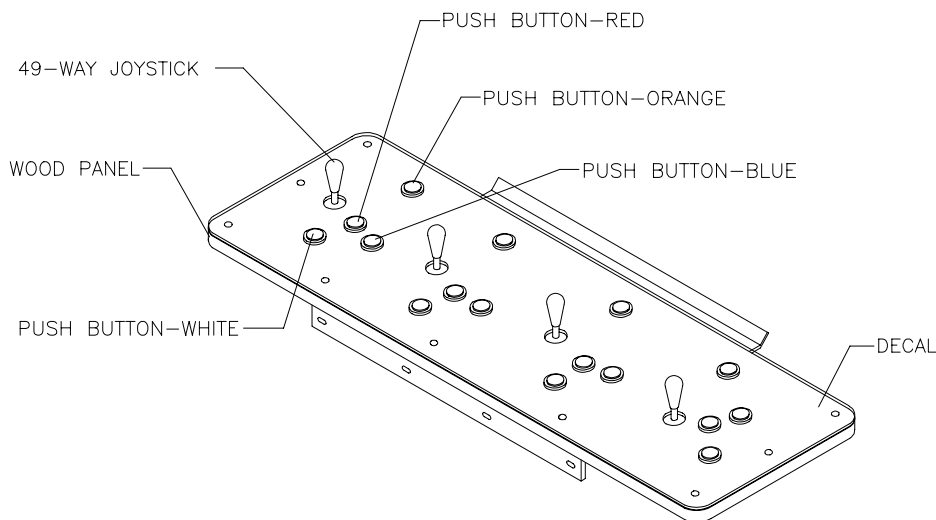

RECOMMENDED PLAYER CONTROL LOCATIONS

GAME RULES FOR *NBA SHOWTIME GOLD EDITION*

INSTRUCTIONS

Play instructions appear on the information panel over and under the video monitor.

ONE TO FOUR PLAYERS

The player or players insert currency to start the game. Each player chooses a joystick and presses the nearest START button. Players select a team and two characters. In four-player games, each player controls one character. In games with fewer players, each player controls one character. The VGM computer controls remaining characters. The VGM computer displays team scores and statistics at the end of each quarter. Additional game information appears on screen as needed.

CONTROLLING CHARACTERS

The joystick and action buttons control characters on the basketball court. The joysticks respond to different amounts of deflection as well as direction.

GAME ACTION

Standard NBA basketball rules apply, except that the game only includes four active characters. Game settings determine game length and speed. The player view of the action changes automatically whenever a better camera angle becomes available. Game sounds include announcer comments and crowd noises.

SCORING

The game awards points for baskets, just as in real basketball games.

PLAYER CONTROLS FOR *NBA SHOWTIME GOLD EDITION*

- **JOYSTICK.** Each player's joystick controls the position of that player's characters on the video screen.
- **PASS/STEAL (the blue button)** controls character actions on the video screen. Press PASS/STEAL to attempt to pass or steal the ball.
- **SHOOT/BLOCK (the red button)** controls character actions on the video screen. Press SHOOT/BLOCK to shoot or attempt to block the ball.
- **START (orange buttons).** Each START button allows the corresponding player to begin or continue play.
- **TURBO (The white button)** controls character actions on the video screen. Press TURBO to speed up the pace of a play.

GAME FEATURES OF *NBA SHOWTIME GOLD EDITION*

NBA Showtime is a thrilling, two-on-two basketball game with world-class realism. Each player selects an NBA team, and then chooses a favorite character. Players can also create their own players. If fewer than four players are in the game, the computer operates the remaining characters.

The red team comprises players 1 and 2. Players 3 and 4 make up the challenging, blue team. The red and blue teams square off for the jump and the action begins. Run the ball down court! A steal! Dribble up court! A snap shot! The breathless announcer describes every pass, every shot, every block, every move!

After each quarter, new players can join the fun. Players can also switch to different characters. When the game concludes, team and individual scores appear on the screen. Top scorers may enter their initials or names with a joystick. *NBA Showtime* displays these initials in a high score table.

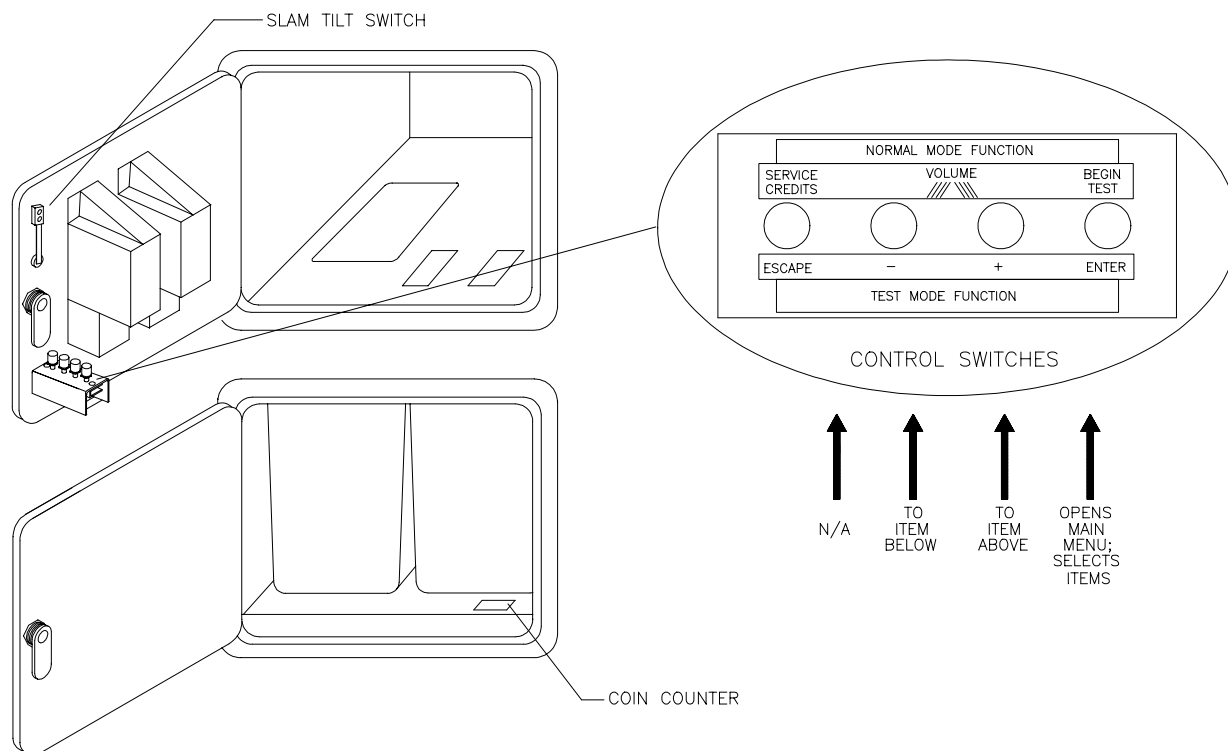

DIAGNOSTIC CONTROL SWITCH LOCATIONS (TYPICAL INSTALLATION)

OPERATOR CONTROLS

CABINET CONTROLS

- **The DIP Switches** set some system variables. You can set other variables with diagnostic control switches.
- **The Monitor Remote Control Board** allows you to adjust the video display for optimum viewing.
- **The POWER Switch** turns off the video game machine, but does not reset game variables.

DIAGNOSTIC CONTROL SWITCHES

- **The SERVICE CREDITS Button** allots credits without changing the game's bookkeeping total. SERVICE CREDITS has no function in the Menu System.

- **The TEST MODE Button** causes the VGM to enter the service Menu System. Press the TEST MODE button briefly to run automatic tests. To make game adjustments, press and hold TEST MODE until the Main Menu appears. Within the Menu System, TEST MODE assumes another function. There, it selects a menu line item and calls up the item's submenu. The screen displays this submenu.
- **VOLUME DOWN and VOLUME UP Buttons** set game sound levels. To make minor volume changes, press either button briefly. To make major changes, press and hold a button. In the Menu System, VOLUME UP moves the item highlight bar up the menu. VOLUME DOWN moves the item highlight bar downward.



NOTICE: You must adjust Attract Mode volume independently of Game Mode volume. For greater profits, increase volume levels to draw attention to this game.



MAINTENANCE

- **Cabinet**
Use only non-abrasive cleaners to avoid damaging game graphics. Apply cleaner to a clean cloth or sponge. Wipe the screen clean with this cloth or sponge. *Do not apply cleaner directly on the cabinet!*
- **Control Panel**
Dirt or debris on the joysticks or buttons can affect earnings. Apply the cleaner to a clean cloth. Use the cloth to wipe the controls. *Don't apply the cleaner directly to the controls!*
- **Viewing Glass**
To clean the glass, you don't need to switch off power to the VGM. Apply a mild glass cleaner to a clean cloth or sponge. Use this to wipe the viewing glass. *Do not apply the cleaner directly on the glass!* Liquid could drip down into switch or motor circuits and cause erratic VGM operation.

SERVICING

Only qualified service personnel should perform maintenance and repairs. The following product guidelines apply to all VGM operators and service personnel. Notes, cautions and warnings appear throughout this manual where they apply. Read the SAFETY pages thoroughly before beginning service.

- **Circuit Board Set**
The VGM computer uses a set of three circuit boards. The three boards include the CPU Board, I/O Board and Video Board. Switch off power to the VGM. Open the rear door. To expose the circuit boards, remove their perforated metal cover. Carefully note the orientation of the JAMMA connector and other cables. Extract the harness and hard disk drive ribbon cable from the board connectors. Remove circuit board mounting screws. Lift the circuit boards out of the cabinet and set them in a safe place. Use anti-static packaging from new parts to store boards that you won't reinstall.

	<p>CAUTION: Circuit board edge connectors are fragile. Take care when separating boards in the board set. Never jam the board connectors together. Never plug them together on an extreme angle. If necessary, carefully straighten bent pins with a small, grounded flat blade screwdriver. Also, don't touch exposed foil on printed circuit boards. Skin oils are corrosive.</p>
	<p>NOTICE: Avoid damage to VGM electronics! Turn off VGM power before servicing circuit boards or any electronic assembly. Never "hot plug" circuit boards.</p>

- **Coin Mechanism**

Switch off power to the VGM. Unlock the coin door and swing it open. To clean or replace a coin mechanism, unlatch and remove it. After reinstallation, ensure that the mechanism seats fully its bracket. Close and lock the release latch, and then close the door. Turn on the VGM and change the mechanism setup. Test known good and bad coins to verify operation.

- **Coin Meter**

Switch off power to the VGM. Unlock the cash door and swing it open. The coin meter mounts to a metal plate at the bottom the cash vault. Record the meter count before testing or replacement. Remove the plate's four mounting screws, and then remove the plate.

Disconnect the meter wiring harness at the connectors. Remove front screws and slide the meter out. Assure that a protective diode connects across the replacement meter's terminals. The diode prevents driver circuit damage.

- **Hard Disk Drive**

Switch off power to the VGM. Unlock and remove the rear cabinet door. Remove the perforated metal cover over the VGM electronics. Disconnect the DC power cable from the hard disk drive. Unplug the ribbon cable from the hard drive. Don't disconnect the cables from the CPU Board. Loosen the drive mounting screws and lift the drive out of its mounting bracket. Remove the screws. Save them for reuse in future hard drive installations. When returning a hard drive to your distributor, pack it in an anti-static bag. Box the drive in approved shipping container 08-8068.



	<p>NOTICE: Hard disk drives are very fragile! Handle them with care. Do not stack or drop hard disk drives. Keep disk drives away from magnets, heat and vibration.</p>
---	--

- **Joysticks**

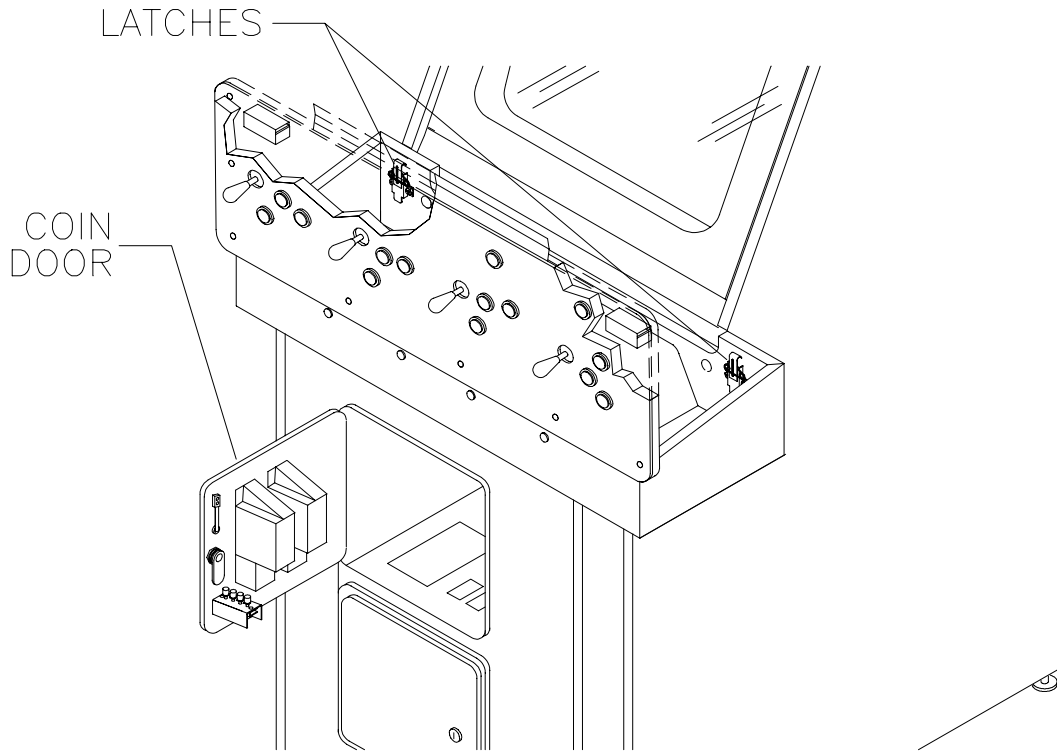
Switch off power to the VGM. Open the player control panel. Mark and disconnect the wiring harness from a joystick. To separate the joystick from the player panel, first remove the joystick shaft. An E-ring secures the shaft. Disengage this E-ring with a small, flatblade screwdriver. Grasp the joystick knob. Extract the stick from the assembly. Then remove 8-32 KEPS® nuts from the corners of the joystick base. Retain fasteners for reassembly.



- **Memory**

	<p>CAUTION: Static electricity builds up on your body. This static can damage or destroy sensitive VGM circuits. BEFORE touching or handling electronic assemblies, discharge static electricity by touching the electronics mounting plate.</p>
	<p>NOTICE: CPU Board and SI/O Board chips don't face same direction. When mounting chips on either board, refer only to chips on the same board for reference. Never use chips another board for reference.</p>

ROM (Read Only Memory) circuits contain computer operating instructions for this VGM. Switch off power to the VGM. Unlock and remove the rear door. Remove the perforated metal cover. Note the ROM chip position. Remove the device with a chip extraction tool. To reinstall a ROM chip, orient the device over its socket. Press the chip firmly to seat pins. *Don't force the chip into the socket.*

VGM ELECTRONICS

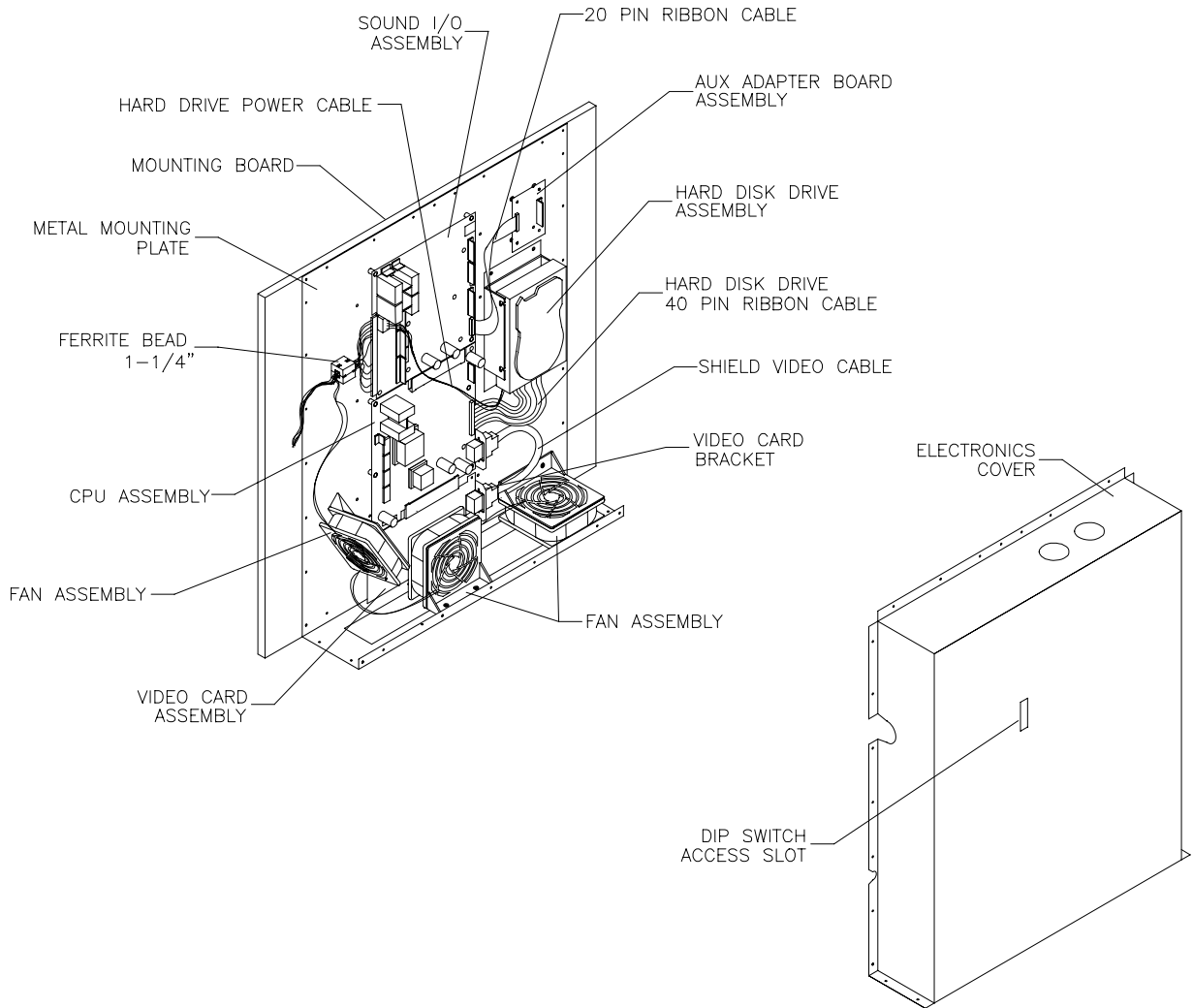

INTERNAL COMPONENTS

- **Monitor**

	<p>CAUTION: The video monitor is heavy, with most of the weight toward the front of the assembly. Support the monitor as you remove it from the cabinet.</p>
---	---



Switch off power to the VGM. Open the control panel. Remove the viewing glass and monitor bezel. Unlock and remove the rear door. Disconnect the monitor from the wiring harness, remote adjustment board, and ground wires. Remove the fasteners that secure the monitor frame to its mounting panel. Carefully pull the monitor from the cabinet. Set the monitor in a safe place. Remove the remote adjustment board from the cabinet and reconnect it to the monitor before servicing or replacement. Clean the face of the CRT before reinstalling the monitor bezel.

NOTES

NBA SHOWTIME GOLD EDITION / NFL BLITZ 2000 GOLD EDITION CONVERSION KIT

CHAPTER THREE

DIAGNOSTIC, AUDIT & ADJUSTMENT MENU SYSTEM FOR *NFL BLITZ 2000 GOLD EDITION* GAMES

	<p>NOTICE: This manual is subject to change without notice. Midway reserves the right to make improvements in equipment as progress in engineering warrants.</p>
	<p>NOTICE: GAME-SELECTION SWITCH. Select <i>NBA Showtime</i> or <i>NFL Blitz</i> by flipping switch 8 at DIP bank U13. Then power down and up again. The Attract Mode for the game you select will appear. <i>The player can still play either game.</i></p>

MENU SYSTEM

WHAT IS THE MENU SYSTEM?

The game's Menu System is a series of auditing, game adjustment and diagnostic screens. We call these screens *menus*, because they present options in menu-like lists. You can easily access and apply menus to optimize game performance. For instance...

- Use game audits menus to assess game performance.
- Use adjustment menus to help you to customize game performance. For instance, you can restore factory default game settings. You can also calibrate player controls for accuracy.
- Use diagnostic menus to verify proper equipment operation.

ACTIVATING THE MENU SYSTEM

Open the coin door. Find the TEST MODE switch inside. Press TEST MODE to invoke the Menu System. The game system responds by exiting Game Mode and entering Diagnostic Mode. You can also invoke the Menu System by turning on DIP bank U12, switch 8. (To reenter Game Mode, turn off switch 8.)

AUTOMATIC TESTS

In Diagnostic Mode, the Power-On Self-Test (POST) activates. This routine runs automatically. It can detect faults that cause game or Menu System malfunctions. POST usually takes less than a minute. The test doesn't display anything. Instead, the system boot loader indicates the software revision number and serial numbers. The system boot loader also displays a sound-loading message and other useful information.

At the end of POST, the system displays the Control Functions Menu.

CONTROL FUNCTIONS MENU

The Control Functions Menu is purely informational. It appears for five seconds. Then the Menu System automatically displays the Dual Game Adjustment Menu.

The Control Functions Menu introduces the menu navigation controls. The key point is that you can use either player or diagnostic controls to navigate menus. Diagnostic control switches are particularly helpful when you must troubleshoot player switches. This manual discusses the controls in more detail in this chapter's *Main Menu* section. Also see the page on the menu that interests you.

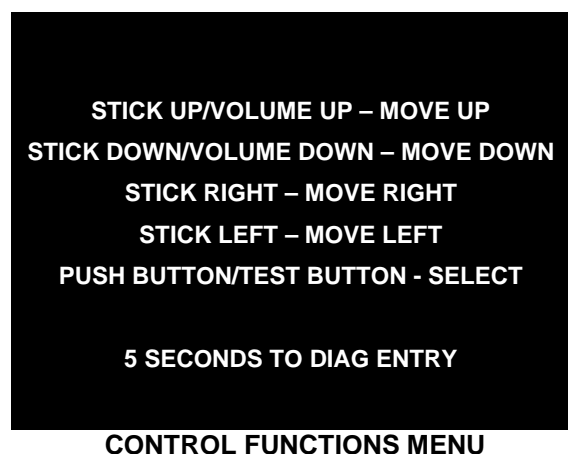

DUAL GAME ADJUSTMENT MENU

The Dual Game Adjustment Menu is another informational, read-only menu. It appears until you choose to exit. This menu reminds you that some *NFL* settings also affect *NBA* game play. Press any button to exit to the Main Menu.

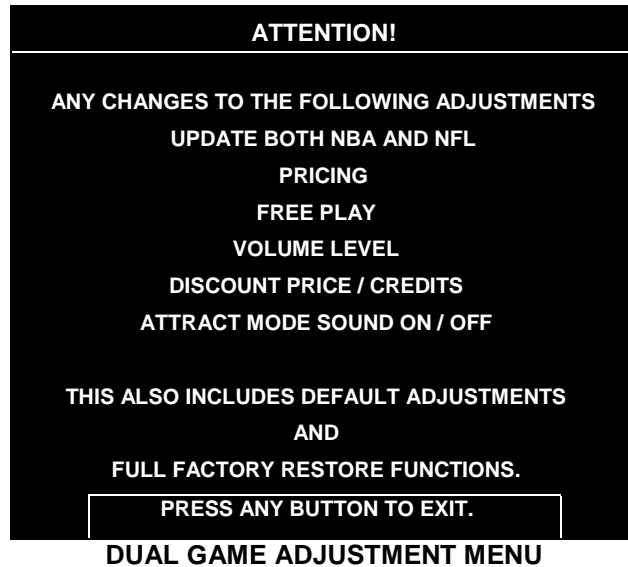

MAIN MENU

The Main Menu offers you access to the game machine's test, bookkeeping and programmable features. Game audits, adjustments and diagnostics are line items on the Main Menu. Selecting an item opens its submenu. Every submenu presents various options that you may act upon.



MENU LAYOUT

Menus differ, but related information tends to occupy the same menu locations.

- The block at the top, center of each menu displays the current menu title.
- Data (menu items, video signals, statistics, reports, etc.) appears in the center of the menu.
- Messages (explanations, control functions, revision levels) display at the bottom of the menu.

MENU NAVIGATION CONTROLS

Use any player panel joystick to highlight a desired menu item. *You can only select one highlighted item at a time.* To select a highlighted item, press any player panel button. Operator control buttons inside the

coin door serve as backup menu navigation controls. Press VOLUME UP or VOLUME DOWN buttons to highlight a menu item. Press TEST MODE to select a highlighted item.

EXIT OPTIONS

To exit the NFL menus and simultaneously enter the NBA menus, choose NBA MAIN MENU. To return the game to play, highlight either EXIT TO NFL or EXIT TO NBA. Your choice determines the game that will boot. Next, press any button.

	NOTICE: This manual depicts some menus as having two pages. Your video game machine may present these same menus as one-pagers. Monitor resolution affects whether a menu has a second screen.
---	---

Main Menu (continued)
Diagnostics Menu

DIAGNOSTICS

Select DIAGNOSTICS at the Main Menu. Diagnostic tests allow you to verify the condition of the electrical and electronic hardware in the game.

Highlight a test with any player panel joystick. Select the option with any player panel button.

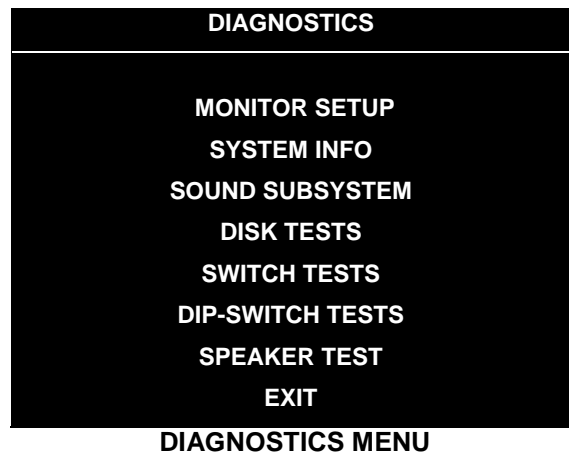

Diagnostic tests assist you in checking and adjusting the game's major systems. By running diagnostics, you can gain an insight into both system hardware and game software. Periodically running diagnostics is a crucial part of maintaining game performance and player satisfaction. Sometimes you can improve game performance by running a diagnostic test and making appropriate adjustments.

Main Menu (continued)
Diagnostics Menu (continued)
Monitor Setup Menu

MONITOR SETUP

Select MONITOR SETUP at the Diagnostics Menu. The Monitor Patterns routine provides test screens to verify monitor performance or make adjustments.

Highlight an option with any player panel joystick. Select the option with any player panel button.

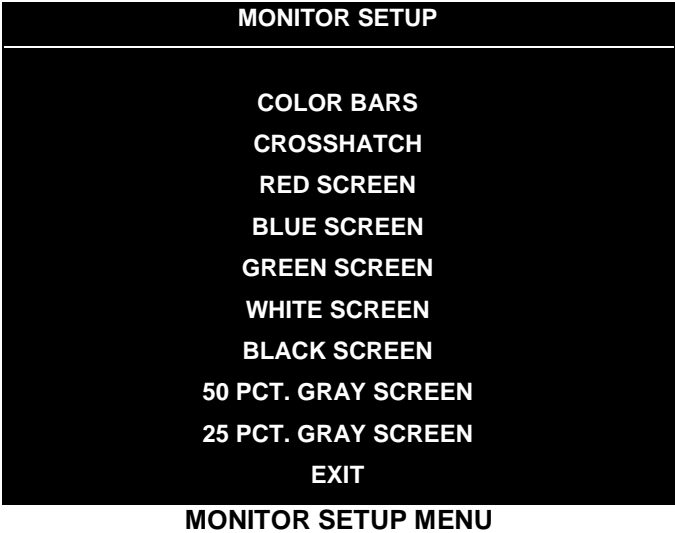

Color Bars fills the screen with colored stripes. Use the color bars to help you to check or adjust monitor brightness and contrast. The color bars also expose defects in horizontal linearity. Each color bar consists of 32 intensity levels. On a properly adjusted monitor, the top 31 of these levels are visible. Each bar should appear sharp, clear and distinct from bars on either side. Incorrect adjustment can cause missing detail at the top or bottom of a bar. Bent bars indicate horizontal linearity flaws, such as pie crust, pincushion or barrel distortion. *(Correct color bar colors, left to right: Red, Green, Blue, Black, White, Cyan, Yellow, Violet.)* Set controls as follows: 1. Adjust BRIGHTNESS and CONTRAST to minimum. 2. Turn up BRIGHTNESS until the pixels in the black stripe begin to glow (turn dark gray). 3. Bring up the CONTRAST control until you can see 31 bars.

Crosshatch Patterns fill the screen with a grid and a series of dots. Crosshatch Patterns help you to check or adjust several monitor parameters: These include convergence, linearity, active viewing area and dynamic focus. The grid and the dots should be all white in color, with no fringes or parallel images. The lines should be straight and the dots round. For more detail on these adjustments, consult service literature from the monitor manufacturer.

Color Screen tests fill the screen with 100% of the chosen color at normal intensity. The Color Screen tests help you to check or adjust monitor intensity, black level, blanking and color purity. Each screen should be absolutely uniform from top to bottom and side to side. No retrace lines or noise should be visible. Color Screens may not hold their uniformity if the monitor degaussing circuit is defective.

White, Gray and Black Screens fill the screen with black, gray or white at various intensities. These monochrome screens help you to check or adjust monitor convergence, purity, contrast and intensity. These screens also simplify black level and color gun control settings. The screens should be uniform with no color tints or distortion. No retrace lines or noise should be visible.

If tests indicate a need for adjustment, use controls on the Monitor Remote Adjustment Board.

Main Menu (continued)
Diagnostics Menu (continued)
System Information Menu

SYSTEM INFORMATION

Select SYSTEM INFO at the Diagnostics Menu. The System Information Menu provides the current version numbers of this game’s hardware and software. Use these numbers to describe the system during parts replacement, service calls, etc.

Highlight an option with any player panel joystick. Select the option with any player panel button.



The System Information screen reports information, but doesn’t permit you to make changes. The Title line identifies the manufacturer of this game and the electronic board set used in this product. The Serial Number, Game and Date of Manufacture identify the game name and production run.

Main Menu (continued)
Diagnostics Menu (continued)
Sound Subsystem Menu

SOUND SUBSYSTEM TEST

Select SOUND SUBSYSTEM at the Diagnostics Menu. Sound Subsystem Tests verify that audio components are connected and operate properly.

Highlight an option with any player panel joystick. Select the option with any player panel button.

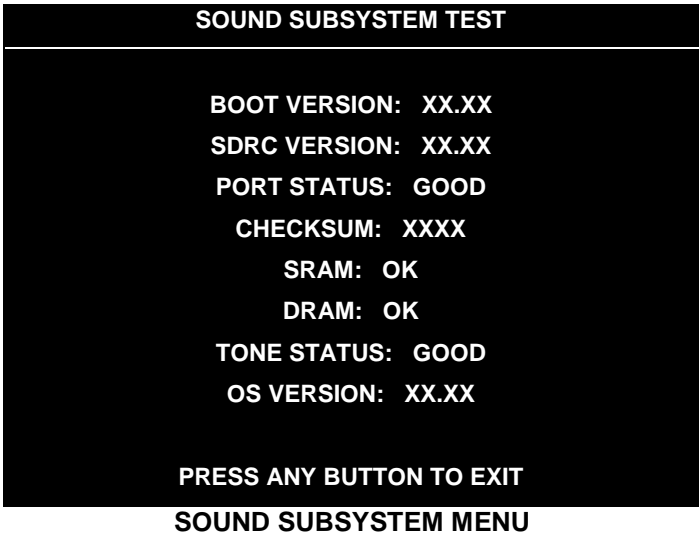

Version, Status, Checksum and RAM Reports are diagnostic routines. These routines analyze the digital sound circuits and can detect sound memory problems. Test results appear as numbers or messages. Sounds may also accompany some tests. Reports other than GOOD or OK indicate a problem.

Main Menu (continued)
Diagnostics Menu (continued)
Disk Tests Menu

DISK TESTS

Select DISK TESTS at the Diagnostics Menu. Disk Tests allow you to verify proper operation of the hard disk drive assembly.

Highlight an option with any player panel joystick. Select the option with any player panel button.

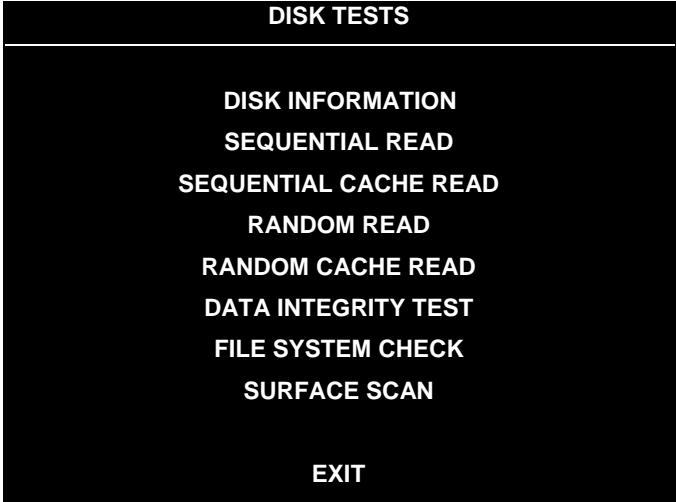

DISK TESTS MENU

Disk Information. The Disk Information routine verifies the interface between the CPU Board Assembly and hard disk drive. The processor requests disk information. Data cannot be retrieved successfully if there is a problem.

Sequential Disk Read. This routine tries to access every bit of data in the order it is stored directly on the disk. The hard disk drive media may be defective if this routine cannot be completed successfully.

Sequential Cache Read. This routine tries to access every bit of data in the order it is stored in the temporary disk memory cache. If this test is not successful, the memory circuits may be faulty.

Random Disk Read. This routine tries to access every bit of data in no particular order directly from the disk. This test may detect problems with ability to position the drive heads accurately over the requested data.

Random Cache Read. This routine tries to access every bit of data in no particular order from the temporary disk memory cache. If the cache fails this test, memory circuits may contain a fault.

Data Integrity Test. This test analyzes the data on the disk drive. The test determines if corrupted data is on the disk. Bad data can cause the program to falter even though the hard disk operates correctly.

File System Check. This routine performs a file-by-file check of the data stored on the hard disk.

Surface Scan. The magnetic material on the disk can become damaged, causing data to be unreadable. This routine locates unusable areas on the disk and marks them for future reference.

Main Menu (continued)
Diagnostics Menu (continued)
Switch Tests Menu

SWITCH TESTS

Select SWITCH TESTS at the Diagnostics Menu. Switch Tests verify proper operation of the game's switches, including buttons and joystick switches.

Activate each switch, and the indicator on the menu changes state. Release the switch and the indicator returns to its previous, normally open or closed condition. You can test any combination of switches together. To exit the test, simultaneously press the middle two control buttons inside the coin door. The Switch Test Menu refers to these buttons as "volume buttons."

PLAYER SWITCH INPUTS TEST							
P1	UP	■	P3	UP	■	LEFT COIN	■
P1	DOWN	■	P3	DOWN	■	RIGHT COIN	■
P1	LEFT	■	P3	LEFT	■	P1 START	■
P1	RIGHT	■	P3	RIGHT	■	SLAM/TILT	■
P1	JUMP	■	P3	JUMP	■	TEST	■
P1	PASS	■	P3	PASS	■	P2 START	■
P1	TURBO	■	P3	TURBO	■	SERVICE CREDIT	■
P2	UP	■	P4	UP	■	CENTER COIN	■
P2	DOWN	■	P4	DOWN	■	EXTRA COIN	■
P2	LEFT	■	P4	LEFT	■	P3 START	■
P2	RIGHT	■	P4	RIGHT	■	P4 START	■
P2	JUMP	■	P4	JUMP	■	VOLUME DOWN	■
P2	PASS	■	P4	PASS	■	VOLUME UP	■
P2	TURBO	■	P4	TURBO	■	BILL VALID.	■
P1 49 WAY		P2 49 WAY		P3 49 WAY		P4 49 WAY	
24		24		24		24	
PRESS BOTH PLAYER 1 AND PLAYER 2 START BUTTONS TO EXIT							

SWITCH TEST MENU

Switches appear on the menu as colored boxes. Red boxes indicate an open state. Green indicates closed. Any other color indicates a fault condition. A single indication on the menu should exactly duplicate a button or joystick change. You'll notice a unique number for a switch recognized by game electronics.

Use Switch Tests to locate crossed wires, intermittent conditions and stuck switches.

	<p>NOTICE: Some switches may not be used with this game. If you can't find one of the listed switches, check the wiring diagram.</p>
---	---

Main Menu (continued)
Diagnostics Menu (continued)
DIP Switch Tests Menu

DIP-SWITCH TESTS

Select DIP-SWITCH TESTS at the Diagnostics Menu. Two 8-position DIP switch banks reside on the SIO Board. DIP-Switch Tests allow you to check the position of the 16 switches in these banks. You can change the setting of any DIP switch without removing the circuit board cage.

The menu displays an illustration of each switch block and the current settings. You can change DIP-switch positions with power on. Set any switch, and then check the menu to verify that the new setting is enabled.

Refer to the charts for assistance in choosing switch positions. (* indicates factory defaults.) To exit the DIP-switch Test, press the left control button (inside the coin door).

Game-Selection Switch. Select *NBA Showtime* or *NFL Blitz* by flipping switch 8 at DIP bank U13. Then power down and up again. After you change the game play, you must change game artwork.

DIP Switch 1 (U13)		SW1	SW2	SW3	SW4	SW5	SW6	SW7	SW8
Coinage Control	DIP Switch CMOS	Off On*							
USA1	Ger1 Fr ECA1 UK1		Off*	Off*	Off*				
USA2	Ger2 Fr ECA2 UK2		On	Off	Off				
USA3	Ger3 Fr ECA3 UK3		Off	On	Off				
USA4	Ger4 Fr ECA4 UK4		On	On	Off				
USA5	Ger5 Fr ECA5 UK5		Off	Off	On				
USA9	Ger9 Fr ECA9 UK9		On	Off	On				
USA10	Ger10 Fr ECA10 UK ECA		Off	On	On				
USA	ECA / Ger ECA / Fr ECA8		On	On	On				
Free Play	(All Countries)		On	On	On				
Country	USA France Germany UK**					Off* On Off On	Off* Off On On		
Game Selection	By player By Switch 8							Off* On	
Game at power up	NBA Showtime NFL Blitz								Off* On

**Except Free Play, which is "on" for SW2 through SW6.

DIP Switch 2 (U12)		SW1	SW2	SW3	SW4	SW5	SW6	SW7	SW8
Joystick Type	8-Way 49-Way	Off On*							
Monitor Resolution	Medium Res Low Res		Off* On						
Unused	-- --			Off On					
Unused	-- --				Off On				
Unused	-- --					Off On			
Player Panel Type	2-Player 4-Player						Off On*		
Power Up Test	Active Inactive							Off On*	
Operating Mode	Game Mode Test Mode								Off* On

Main Menu (continued)
Diagnostics Menu (continued)
Speaker Test Menu

SPEAKER TEST

Select SPEAKER TEST at the Diagnostics Menu. The Speaker Test provides audio signals to test the loudspeakers.

Use tests on the Speaker Test menu to verify operation of audio system components. Highlight an option with any player panel joystick. Select the option with any player panel button.

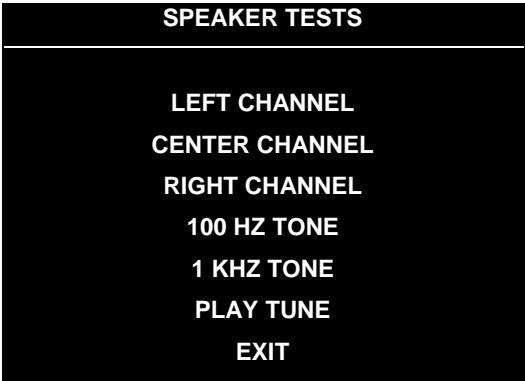

SPEAKER TEST MENU

Channel and Tone Tests. The channel subtests employ voice announcements to verify speaker locations. Use the 100 Hz tone to check the speakers' bass response. Small speakers with weak magnets or poor baffles may cause poor bass response.

Play Tune repeats a series of game sounds. Use PLAY TUNE to check speaker operation and fidelity. If your game has stereo speakers, run PLAY TUNE and test speaker phasing. Muddy, weak or distorted sound during this test may indicate crossed wires or out-of-phase speaker connections. Missing sounds may indicate audio cabling errors.

	<p>NOTICE: Check the volume setting before testing. To test the speakers thoroughly, increase the volume level. Before returning to Game-Over Mode, reset the volume level to its original setting.</p>
--	--

Main Menu (continued)

Audits Menu

AUDITS

Select AUDITS at the Main Menu. The Audits menus permit you to review game play statistics. Additional menus give detailed reports for each player position on game starts, ends, cabinet abuse, fault conditions, etc.

Highlight an option with any player panel joystick. Select the option with any player panel button. The menu displays a list of the statistics available to you. Select an item to view the detailed report.



AUDITS MENU

Data in the Audits menus helps you to keep records of the game's popularity and earning potential. Use the highlight bar to select the desired subject on the Audits Menu. Each entry on the Audits Menu is the subject for an entire menu of bookkeeping information. On these menus, you can track favorite teams, frequently used offensive and defensive plays, etc.

Some audits menus also include histograms. Histogram menus allow graphical analysis of statistics. This permits visual comparisons between games. Histograms have no bar graphs until the system acquires enough data to plot.

Examine and record all game audit values before performing game service or repairs.



NOTICE: Be careful when clearing audit information. Once you clear data, you can't restore it.

Main Menu (continued)
Audits Menu (continued)
Coin Audits Menu

COIN AUDITS

Select COIN AUDITS at the Audits Menu. The Coin Audits menu permits you to assess the currency collection. This report menu presents revenue quantities and other important game statistics. Coin Audits is a read-only menu.

To exit, press any player panel button.

COIN AUDITS – PAGE: 1	
LEFT SLOT COINS	XXXXXXXX
RIGHT SLOT COINS	XXXXXXXX
BILLS	XXXXXXXX
CENTER SLOT COINS	XXXXXXXX
EXTRA SLOT COINS	XXXXXXXX
GAME STARTS	XXXXXXXX
MID-GAME STARTS	XXXXXXXX
CONTINUES	XXXXXXXX
FREE QUARTERS AWARDED	XXXXXXXX
FREE GAMES AWARDED	XXXXXXXX
SERVICE CREDITS	XXXXXXXX
TOTAL PLAYS	XXXXXXXX
UP - NEXT / BUTTON - EXIT	

COIN AUDITS MENU, PAGE 1

The Coin Audits menu reports total quantities of coins, bills or credits collected by each active device. The menu doesn't calculate the value of the collected currency.

This menu reports information, but doesn't permit you to make changes. To reset the coin, bill and credit counters to zero, use the Clear Audits menu.

We recommend that you examine and record audit information before you make changes. Once you've cleared the counters, you can't retrieve the previous data from the system.

COIN AUDITS – PAGE: 2	
TOTAL PAID CREDITS	XXXXXXXX
TOTAL	XXXXXXXX
DOWN - PREV / BUTTON - EXIT	

COIN AUDITS MENU, PAGE 2

Main Menu (continued)
Audits Menu (continued)
Credits Audits Menu

CREDITS AUDITS

Select CREDITS AUDITS at the Audits Menu. The Credits Audits menu permits you to assess the currency collection. This report menu presents revenue quantities and other important game statistics. Credits Audits is a read-only menu.

To exit, press any player panel button.

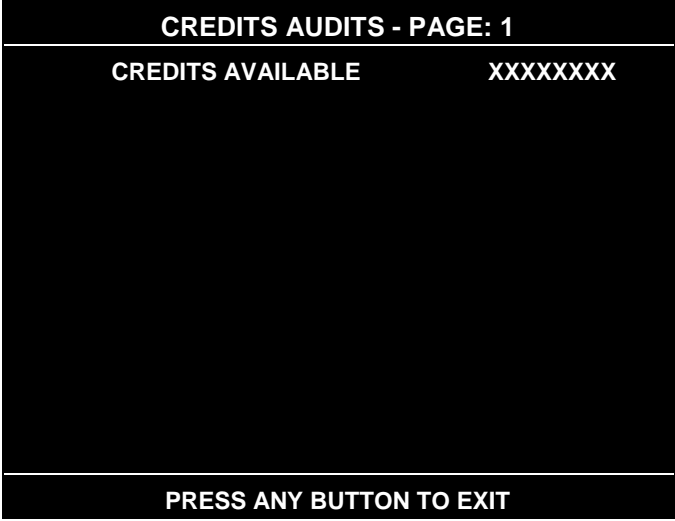

CREDITS AUDITS MENU

Main Menu (continued)
Audits Menu (continued)
Game Audits Menu

GAME AUDITS

Select GAME AUDITS at the Audits Menu. The Game Audits menus permit you to review the game play statistics. Game Audits is a read-only menu.

To exit, press any player panel button.

GAME AUDITS - PAGE: 1			
TOTAL UPTIME	XX	2 QUARTER GAMES	XX
TOTAL PLAY TIME	XX	3 QUARTER GAMES	XX
GAME STARTED	XX	4 QUARTER GAMES	XX
INITIALS ENTERED	XX	WENT INTO OVERTIME 1	XX
<FG> PURCHASED AT START	XX	WENT INTO OVERTIME 2	XX
CREATE PLAY SESSIONS	XX	WENT INTO OVERTIME 3	XX
1 PLAYER	XX	1 PLAYER FINISHES	XX
2 PLAYER	XX	2 PLAYER FINISHES	XX
3 PLAYER	XX	3 PLAYER FINISHES	XX
4 PLAYER	XX	4 PLAYER FINISHES	XX
2P V CPU	XX	2P V CPU FINISHES	XX
1 QUARTER GAMES	XX	H VS H LSW'S	XX
		CPU WINS (FG)	XX
		AVG H VS H TOTAL SCORE (FG)	XX
		AVG H VS CPU TOTAL SCORE (FG)	XX
		AVG H VS H WIN SCORE (FG)	XX

UP – NEXT / BUTTON - EXIT

GAME AUDITS MENU, PAGE 1

The Game Audits menu reports information, but doesn't permit you to make changes. Examine and record information at GAME AUDITS before deleting data at the Clear Audits Menu. Once you've cleared the counters, you can't retrieve the previous data from the system.

GAME AUDIT MENU TERMS

TERM	DEFINITION	TERM	DEFINITION
AVG	Average	LSW	Your game computer's internal record-keeping counters
CPU	Central Processing Unit: The game computer	Machine Power-On	Number of power cycles (game turn-ons)
<FG>, (FG)	Full Game	OT	Overtime
H VS CPU	Human versus CPU: Competition that pits players against the game computer	P V	Player versus...
H VS H	Human versus human: Competition between human players	Total Uptime	Overall on-time for the game computer
		2PV	Two players versus...

GAME AUDITS - PAGE: 2

AVG H VS H LOSS SCORE (FG)	XX
BIGGEST CPU WIN MARGIN (FG)	XX
BIGGEST CPU LOSS MARGIN (FG)	XX
TLF'S	XX
SBLF'S	XX

DOWN – PREV / BUTTON - EXIT

GAME AUDITS MENU, PAGE 2

Main Menu (continued)
Audits Menu (continued)
Team Stats Menu

TEAM STATS

Select TEAM STATS at the Audits Menu. Team Stats details the number of games played by each team in the league. Team Stats is a read-only menu.

To exit, press any player panel button.

TEAM STATS – PAGE: 1			
ARIZONA CARDINALS	0	MINNESOTA VIKINGS	0
ATLANTA FALCONS	0	NEW ENGLAND PATRIOTS	0
BALTIMORE RAVENS	0	NEW ORLEANS SAINTS	0
BUFFALO BILLS	0	NEW YORK GIANTS	0
CAROLINA PANTHERS	0	NEW YORK JETS	0
CHICAGO BEARS	0	OAKLAND RAIDERS	0
CINCINNATI BENGALS	0	PHILADELPHIA EAGLES	0
CLEVELAND BROWNS	0	PITTSBURCH STEELERS	0
DALLAS COWBOYS	0	SAN DIEGO CHARGERS	0
DENVER BRONCOS	0	SAN FRANCISCO	0
DETROIT LIONS	0	SEATTLE SEAHAWKS	0
GREEN BAY PACKERS	0	ST. LOUIS RAMS	0
INDIANAPOLIS COLTS	0	TAMPA BAY BUCS	0
JACKSONVILLE JAGUARS	0	TENNESSEE TITANS	0
KANSAS CITY CHIEFS	0	WASHINGTON REDSKINS	0
MIAMI DOLPHINS	0		

PRESS ANY BUTTON TO EXIT

TEAM STATS MENU

Main Menu (continued)
Audits Menu (continued)
Offensive Plays Menu

OFFENSIVE PLAYS

Select OFFENSIVE PLAYS at the Audits Menu. Offensive Plays accounts for each play type as a percentage of all offensive plays. Offensive Plays is a read-only menu.

To exit, press any player panel button.

OFFENSIVE PLAYS – PAGE: 1			
TEAMPLAY 1	0%	BLIZZARD	0%
TEAMPLAY 2	0%	CRISS CROSS	0%
TEAMPLAY 3	0%	UP THE GUT	0%
ZIG ZAG	0%	SCREEN RIGHT	0%
SPIDER LEGS	0%	SUPER FLY	0%
MONKEY	0%	MIDDLE PICK	0%
SLIP SLIDE	0%	SWEEP RIGHT	0%
QB POST	0%	REVERSE ZIP	0%
QUICK DISH	0%	HB BLOCK	0%
UPPER CUT	0%	EXTRA PLAY 1	0%
DA BOMB	0%	EXTRA PLAY 2	0%
HAIL MARY 2	0%	EXTRA PLAY 3	0%
TURMOIL	0%	EXTRA PLAY 4	0%
BACK SPLIT	0%	EXTRA PLAY 5	0%
SUBZERO	0%	EXTRA PLAY 6	0%
DAWG HOOK	0%	EXTRA PLAY 7	0%
U.T.B. DEEP	0%	EXTRA PLAY 8	0%
CROSS SLANT	0%	EXTRA PLAY 9	0%
PRESS ANY BUTTON TO EXIT			

OFFENSIVE PLAYS MENU, PAGE 1

OFFENSIVE PLAYS – PAGE: 2	
PUNT	0%
FAKE PUNT	0%
FIELD GOAL	0%
FAKE F.G.	0%
EXTRA POINT	0%
PRESS ANY BUTTON TO EXIT	

OFFENSIVE PLAYS MENU, PAGE 2

Main Menu (continued)
Audits Menu (continued)
Defensive Plays Menu

DEFENSIVE PLAYS

Select DEFENSIVE PLAYS at the Audits Menu. Defensive Plays accounts for each play type as a percentage of all defensive plays. Defensive Plays is a read-only menu.

To exit, press any player panel button.

DEFENSIVE PLAYS – PAGE: 1			
SAFE COVER	0%		
1 MAN BLITZ	0%	BLOCK FG	0%
2 MAN BLITZ	0%	BLOCK PUNT	0%
SUICIDE BLITZ	0%	PUNT RETURN	0%
ZONE BLITZ	0%		
NEAR ZONE	0%		
MEDIUM ZONE	0%		
DEEP ZONE	0%		
GOAL LINE	0%		
EXTRA PLAY 1	0%		
EXTRA PLAY 2	0%		
EXTRA PLAY 3	0%		
EXTRA PLAY 4	0%		
EXTRA PLAY 5	0%		
EXTRA PLAY 6	0%		
EXTRA PLAY 7	0%		
EXTRA PLAY 8	0%		
EXTRA PLAY 9	0%		
PRESS ANY BUTTON TO EXIT			

DEFENSIVE PLAYS MENU

Main Menu (continued)
Audits Menu (continued)
Exception Dump Menu

EXCEPTION DUMP

Select EXCEPTION DUMP at the Audits Menu. Game programmers use the Exception Dump Menu to view register contents during program development. This menu has no field purpose. Exception Dump is a read-only menu.

To exit, press any player panel button.

Main Menu (continued)
Audits Menu (continued)
Clear Audits Menu

CLEAR AUDITS

Select CLEAR AUDITS at the Audits Menu. The Clear Audits menu allows you to clear individual memory counters or to reset them all at once.

Highlight an option with any player panel joystick. Select the option with any player panel button.



You can reset any audit menu from the Clear Audits Menu. Choose an item and zero its counter. CLEAR ALL simultaneously changes all audit categories to factory default values. After you've selected an item, the system gives you the opportunity to escape this change. For example:

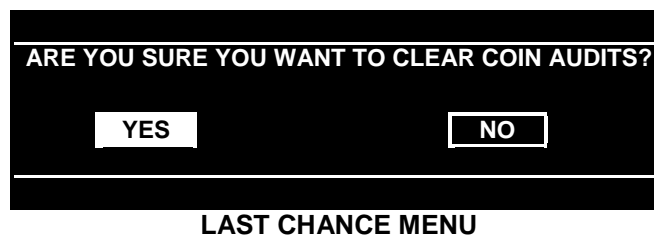

After you've selected and verified a clear function, the values reset. The system can't restore the previous values. Examine and record utility values before you make changes.

Main Menu (continued)

Adjustments Menu

ADJUSTMENTS

Select ADJUSTMENTS at the Main Menu. The Adjustments menus permit you to change game characteristics. Use these menus to optimize game performance and earnings.

Highlight an option with any player panel joystick. Select the option with any player panel button.



Main Menu (continued)

Adjustments Menu (continued)

Pricing Menu

PRICING

Select PRICING at the Adjustments Menu. The Pricing menus allow you to view current settings or change the cost of games. Custom pricing allows you to select the number of coins or credits required for each game. The game restores factory default values if you exchange the CPU Board or if the backup battery fails.

Highlight an option with any player panel joystick. Select the option with any player panel button.

You may reset options to factory defaults or change an option after viewing it. We recommend examining and recording pricing options before making changes.

You may save several custom prices and then choose between them as needed. On-screen instructions guide you through the process of creating custom price settings.



An additional box appears on screen to explain the available functions as you select each item.

STANDARD PRICING TABLE

NAME	START	CONTINUE	CREDITS/COIN	COIN 1	COIN 2	COIN 3	COIN4	BILL
ANTILLES	2	2	1/25¢, 4/1G	.25¢	1G			
AUSTRALIA 1	2	2	1/3X20¢, 2/\$1.00	.20¢	\$1.00			
AUSTRALIA 2	1	1	1/5X20¢, 1/\$1.00	.20¢	\$1.00			
AUSTRIA 1	2	2	1/5Sch, 2/10Sch	5 Sch	10 Sch			
AUSTRIA 2	2	2	1/2X5Sch, 3/2X10Sch	5 Sch	10 Sch			
BELGIUM 1	2	2	1/20BF	20BF	20BF			
BELGIUM 2	2	2	3/20BF	20BF	20BF			
BELGIUM 3	2	2	2/20BF	20BF	20BF			
BELGIUM ECA	2	2	1/20BF	50BF	20BF	5BF		
CANADA 1	2	2	1 / 2 x 25¢, 3 / \$1	25¢	25¢			
CANADA 2	2	2	1 / 2 x 25¢, 3 / \$1	25¢	\$1.00			
CANADA 3	2	2	3 / \$1.00, 6 / \$2.00	\$1.00	\$2.00			
CANADA ECA	2	2	1 / 2 x 25¢, 3 / \$1	25¢		\$1.00	\$2.00	
DENMARK	2	2	3/5DKr, 7/10DKr	5DKr	10DKr			
FINLAND	2	2	1/1Fmk	1Fmk	5Fmk			
FRANCE 1	2	2	2/5Fr, 5/10Fr	5Fr	10Fr			
FRANCE 2	2	1	2/5Fr, 4/10Fr	5Fr	10Fr			
FRANCE 3	2	1	1/5Fr, 3/10Fr	5Fr	10Fr			
FRANCE 4	2	1	1/5Fr, 2/10Fr	5Fr	10Fr			
FRANCE 5	2	1	2/5Fr, 5/10Fr, 11/2 X 10Fr	5Fr	10Fr			
FRANCE 6	2	1	2/5Fr, 4/10Fr, 9/2 X 10Fr	5Fr	10Fr			
FRANCE 7	2	1	1/5Fr, 3/10Fr, 7/2 X 10Fr	5Fr	10Fr			
FRANCE 8	2	1	1/5Fr, 2/10Fr, 5/2 X 10Fr	5Fr	10Fr			
FRANCE 9	2	1	1/3 X 1Fr, 2/5Fr	1Fr	5Fr			
FRANCE 10	2	1	1/2 X 1Fr, 3/5Fr	1Fr	5Fr			
FRANCE 11	2	1	1/3 X 1Fr, 2/5Fr, 5/2 X 5Fr	1Fr	5Fr			
FRANCE 12	2	1	1/2 X 1Fr, 3/5Fr, 7/2 X 5Fr	1Fr	5Fr			
FRANCE ECA 1	1	1	2/5Fr, 5/10Fr	1Fr	5Fr	10Fr	20Fr	
FRANCE ECA 2	1	1	2/5Fr, 4/10Fr	1Fr	5Fr	10Fr	20Fr	
FRANCE ECA 3	1	1	1/5Fr, 3/10Fr	1Fr	5Fr	10Fr	20Fr	
FRANCE ECA 4	1	1	1/5Fr, 2/10Fr	1Fr	5Fr	10Fr	20Fr	
FRANCE ECA 5	1	1	2/5Fr, 5/10Fr, 11/2 X 10Fr	1Fr	5Fr	10Fr	20Fr	
FRANCE ECA 6	1	1	2/5Fr, 4/10Fr, 9/2 X 10Fr	1Fr	5Fr	10Fr	20Fr	
FRANCE ECA 7	1	1	1/5Fr, 3/10Fr, 7/2 X 10Fr	1Fr	5Fr	10Fr	20Fr	
FRANCE ECA 8	1	1	1/5Fr, 2/10Fr, 5/2 X 10Fr	1Fr	5Fr	10Fr	20Fr	
FRANCE ECA 9	1	1	1/3 X 1Fr, 2/5Fr	1Fr	5Fr	10Fr	20Fr	
FRANCE ECA 10	1	1	1/2 X 1Fr, 3/5Fr	1Fr	5Fr	10Fr	20Fr	
FRANCE ECA 11	1	1	1/3 X 1Fr, 2/5Fr, 5/10Fr	1Fr	5Fr	10Fr	20Fr	
FRANCE ECA 12	1	1	1/2 X 1Fr, 3/5Fr, 7/10Fr	1Fr	5Fr	10Fr	20Fr	
FRANCE ECA 13	1	1	1/10Fr, 2/20Fr, 4/30Fr	1Fr	5Fr	10Fr	20Fr	
FREE PLAY	--	--	--	None	None	None	None	None
GERMANY 1	2	2	1/1DM, 6/5DM	1DM	5DM			
GERMANY 2	2	1	1/1DM, 7/5DM	1DM	5DM			
GERMANY 3	2	1	1/1DM, 8/5DM	1DM	5DM			
GERMANY 4	2	1	1/1DM, 5/5DM	1DM	5DM			
GERMANY 5	2	1	1/1DM, 6/5DM	1DM	5DM			
GERMANY ECA 1	2	2	1/1DM, 2/2DM, 6/5DM	1DM	2DM	5DM		
GERMANY ECA 2	2	1	1/1DM, 2/2DM, 6/5DM	1DM	2DM	5DM		
GERMANY ECA 3	1	1	1/1DM, 2/2DM, 6/5DM	1DM	2DM	5DM		
HUNGARY	2	2	1/2X10Ft, 3/2X20Ft	10Ft	20Ft			
ITALY	2	2	1/500Lit	500Lit	500Lit			
JAPAN 1	2	2	1/100Yen	100	100			
JAPAN 2	2	2	2/100Yen	100	100			
JAPAN 3	1	1	1/100Yen	100	100			
JAPAN 4	1	1	2/100Yen	100	100			
JAPAN 5	1	1	4/100Yen	100	100			
JAPAN 6	1	1	1/2X100Yen	100	100			
NETHERLANDS	2	2	1/1HFI, 3/2.5HFI	1HFI	2.5HFI			
NEW ZEALAND 1	1	1	1/\$1	\$1	\$2			
NEW ZEALAND 2	1	1	2/\$1	\$1	\$2			
NORWAY	2	2	3/5Nkr, 6/10Nkr	5Nkr	10Nkr			
SPAIN 1	2	2	1/100Pta, 6/500Pta	100Pta	500Pta			
SPAIN 2	2	2	1/100Pta, 5/500Pta	100Pta	500Pta			
SWEDEN	2	2	1/3X1SKr, 2/5SKr	1SKr	5SKr			
SWITZERLAND 1	2	2	1/1SFr, 6/5SFr	1SFr	5SFr			
SWITZERLAND 2	2	2	1/1SFr, 7/5SFr	1SFr	5SFr			
SWITZERLAND 3	2	2	1/1SFr, 8/5SFr	1SFr	5SFr			

(Table continues on next page)

STANDARD PRICING TABLE, *continued*

NAME	START	CONTINUE	CREDITS/COIN	COIN 1	COIN 2	COIN 3	COIN4	BILL
UK ECA 1	1	1	1/50p, 3/£1.00	£1.00	50p	20p	10p	£2.00
UK ECA 2	1	1	1/50p, 2/£1.00	£1.00	50p	20p	10p	£2.00
UK ECA 3	1	1	1/30p, 2/50p, 5/£1.00	£1.00	50p	20p	10p	£2.00
UK 4	1	1	1/50p, 3/£1.00	£1.00	50p			
UK 5	1	1	1/50p, 2/£1.00	£1.00	50p			
UK ECA 6	1	1	1/30p, 2/50p, 4/£1.00	£1.00	50p	20p	10p	£2.00
UK ECA 7	1	1	3/£1.00	£1.00	50p	20p	10p	£2.00
UK ECA 8	1	1	1/50p, 2/£1.00, 4/£2.00	£1.00	50p	20p	10p	£2.00
USA1	2	2	1/25¢	25¢	25¢			\$1.00
USA2	2	1	1/25¢	25¢	25¢			\$1.00
USA3	1	1	1/25¢	25¢	25¢			\$1.00
USA4	1	1	1/50¢, 3/\$1.00	25¢	25¢			\$1.00
USA5	2	1	1/50¢, 4/\$1.00	25¢	25¢			\$1.00
USA6	1	1	1/50¢	25¢	25¢			\$1.00
USA7	1	1	1/50¢, 3/\$1.00	25¢	25¢			\$1.00
USA8	2	2	1/50¢, 4/\$1.00	25¢	25¢			\$1.00
USA9	3	2	1/25¢, 4/\$1.00	25¢	25¢			\$1.00
USA10	3	3	1/25¢, 4/\$1.00	25¢	25¢			\$1.00
USA11	4	2	1/25¢, 4/\$1.00	25¢	25¢			\$1.00
USA12	4	3	1/25¢, 4/\$1.00	25¢	25¢			\$1.00
USA13	4	4	1/25¢, 4/\$1.00	25¢	25¢			\$1.00
USA ECA	3	3	1/25¢, 4/\$1.00	\$1.00	25¢	10¢	05¢	\$1.00

Main Menu (<i>continued</i>)
Adjustments Menu (<i>continued</i>)
Pricing Menu (<i>continued</i>)
Current Pricing Menu

Current Pricing

Select SHOW CURRENT at the Pricing Menu. The Current Pricing Menu is a read-only menu. Use it to check pricing parameters for the pricing table your game is using. To select a new pricing table, return to the Pricing Menu. To invent your own pricing table, select Custom Pricing on the Pricing Menu.

Press any START button to exit from the menu.

CURRENT PRICING	
LEFT SLOT UNITS	XX
RIGHT SLOT UNITS	XX
CENTER SLOT UNITS	XX
EXTRA SLOT UNITS	XX
BILL VALIDATOR UNITS	XX
UNITS PER CREDIT	XX
UNITS PER BONUS	XX
MINIMUM UNITS	XX
CREDITS TO START	XX
CREDITS TO CONTINUE	XX
MAX CREDITS	XX
COINS PER BILL	XX
PRESS ANY BUTTON TO EXIT	

CURRENT PRICING MENU

The following table clarifies Pricing Menu terms...

MENU TERM	DISCUSSION
Slot Units; Bill Validator (DBV) Units	Cyber-currency. This adjustment assigns a number of "units" to each coin mechanism or bill acceptor. For instance, if a quarter buys 1 unit, then \$1 buys 4 units. (<i>See Coins per Bill.</i>) You insert a coin into a 1-unit coin acceptor. The system, due to its programming, knows that your coin is worth one unit.
Units per Credit	How many units equal one credit. (Units buy credit, the price of one game.)
Units per Bonus	Units awarded when a player earns a bonus.
Minimum Units	Until this many units accumulate, the system awards no credits.
Credits to Start	Number of games a player must purchase to begin play.
Credits to Continue	Number of games a player must purchase to resume play.
Max Credits	Limits the number of credits that the game will accept.
Coins per Bill	How many coins one bill is worth.

Main Menu (continued)
Adjustments Menu (continued)
Pricing Menu (continued)
Custom Pricing Menu

Custom Pricing

Select CUSTOM PRICING at the Pricing Menu. The Custom Pricing Menu permits you to program and use your own pricing table. You can save several pricing schemes and chose between them as desired.

Highlight an option with any player panel joystick. Change the option with any player panel button. Press any START button to save your pricing table and exit from the menu.



CUSTOM PRICING OPENING MENU

Add allows you to write a new custom pricing scheme. If you choose ADD, the system directs you to...

- [] 1. Name your scheme.
- [] 2. Program pricing information.
- [] 3. Select the coin denomination for your scheme.
- [] 4. Retain or alter the pricing screen message. (Later, check it in Game Mode by pressing START.)
- [] 5. Save your pricing scheme.
- [] 6. Use your pricing scheme by selecting it.

Delete permits you to eliminate a single custom pricing scheme.

Edit lets you modify a stored custom pricing scheme.

Delete, when enabled, clears all custom pricing schemes.

Select enables you to choose which custom pricing scheme is the active one.

Main Menu (continued)
Adjustments Menu (continued)
Pricing Menu (continued)
Custom Pricing Menu (continued)
Creating Pricing Scheme Menu

Creating Pricing Scheme

After you name your custom pricing scheme, you encounter the Creating Pricing Scheme Menu. This menu is where you program the pricing scheme. You can save several pricing schemes and choose between them as desired.

Highlight an option with any player panel joystick. Select Change Mode with any player panel button. Use a joystick to change the option. Save your setting by pressing any player panel button. Press any START button to exit from the menu. Exiting invokes the Select Currency Menu. Use this menu to choose the coin denomination that players will use. Exit by choosing DONE.

CREATING XXXX			
LEFT UNITS	XX	RIGHT UNITS	XX
CENTER UNITS	XX	EXTRA UNITS	XX
DBV UNITS	XX	UNITS PER CREDIT	XX
UNITS / BONUS	XX	MIN UNITS	XX
CREDITS TO START	XX	CREDITS TO CONT.	XX
MAX CREDITS	XX	COINS / BILL	XX
SHOW FRACTIONS	XX	LEFT COUNT	XX
RIGHT COUNT	XX	CENTER COUNT	XX
EXTRA COUNT	XX	DBV COUNT	XX
USE STICK TO SELECT AN ITEM TO MODIFY			
PRESS ANY BUTTON TO MODIFY THE ITEM			
PRESS ANY START BUTTON TO SAVE AND EXIT			

CUSTOM PRICING MENU

SELECT CURRENCY
DOLLAR
POUND
GUILDER
SCHILLING
FRANC
KRONE
MARKKA
DEUTSCHE MARK
LIRE
FORINT
PESETA
YET
DONE

SELECT CURRENCY MENU (PAGE 2 OF CREATING XXXX MENU)

The Custom Pricing Menu employs the same terms that appear on the Current Pricing Table. See the table below for definitions of these terms.

PRICING MENU TERMS

MENU TERM	DISCUSSION
Slot Units; Bill Validator (DBV) Units	Cyber-currency. This adjustment assigns a number of “units” to each coin mechanism or bill acceptor. For instance, if a quarter buys 1 unit, then \$1 buys 4 units. (<i>See Coins per Bill.</i>) You insert a coin into a 1-unit coin acceptor. The system, due to its programming, knows that your coin is worth one unit.
Units per Credit	How many units equal one credit. (Units buy credit, the price of one game.)
Units per Bonus	Units awarded when a player earns a bonus.
Minimum Units	Until this many units accumulate, the system awards no credits.
Credits to Start	Number of games a player must purchase to begin play.
Credits to Continue	Number of games a player must purchase to resume play.
Max Credits	Limits the number of credits that the game will accept.
Coins per Bill	How many coins one bill is worth.

BASIC CUSTOM PRICING. Custom pricing creates an imaginary currency exchange. In this currency exchange, the coins of the realm are “units.” Think of units as a type of cyber-currency, useful only within the game software. By inserting coins, you purchase units.

Since units are only negotiable within game software, the system stores your units for you. When the system receives enough units, it buys a game for you. The price of a game is one “credit.” You can think of credits as a second form of cyber-currency.

Even though you’ve now bought one game, you may not be able to begin playing. In many pricing schemes, you must buy two or more credits to begin play. The idea here is something like a minimum order of goods at a store. That is, the operator can “shrink-wrap” two or more games in a package. You can’t play unless you buy the entire package.

• **1 / 25¢ COIN; 1 CREDIT TO START.** In a simple, quarter pricing scheme, the player inserts one coin to buy one unit. The system exchanges that unit for one credit. If CREDITS TO START contains the value one, then play commences. A dollar bill buys four units.

Left Slot Units	Validator Units	Units / Credit	Credits to Start	Coins / Bill
1	4	1	1	4

• **1 / 3 X 25¢; 2 CREDITS TO START.** Again, assuming quarter slots, here’s one way to implement 75¢ pricing... In this scheme, each coin that the player inserts buys one unit. The system exchanges three units for one credit. CREDITS TO START contains the value two. To play, the player must pay for two credits. In this scheme, a dollar buys four units.

Left Slot Units	Validator Units	Units / Credit	Credits to Start	Coins / Bill
1	4	3	2	4

• **2 / 1 COIN; 6 CREDITS TO START.** Now let’s consider a more unusual pricing scheme. Here, the player can buy two units with one coin. The system exchanges each of these units for one credit. Notice that CREDITS TO START contains the value six. To play, the player must insert two more coins to pay for six credits. Also notice that if the player pays with a bill, the system throws in an extra unit.

Left Slot Units	Validator Units	Units / Credit	Credits to Start	Coins / Bill
2	9	1	6	4

Main Menu (continued)
Adjustments Menu (continued)
Pricing Menu (continued)
Custom Pricing Menu (continued)
Current Pricing Prompt

Pricing Prompt

After you exit the Select Currency Menu, you encounter the Current Pricing Prompt Menu. The Current Pricing Prompt Menu allows you to enter a brief pricing or advertising message. The video game machine displays your message during the Attract Mode.

Select YES at the menu's first page. The Screen Message Entry Menu opens. You may enter up to three lines of text. Each line may include up to 32 alphanumeric characters. Here's an example message...

1 CREDIT / 2 COINS
EAT AT JOE'S

Highlight a letter with any player panel joystick. Select the letter with any player panel button. Delete the rightmost character of the default message by selecting the on-screen asterisk (*). Watch the bottom of the screen to see your message line develop. Save the entire line and proceed to the second line by selecting the arrow (>).



CURRENT PRICING PROMPT MENU

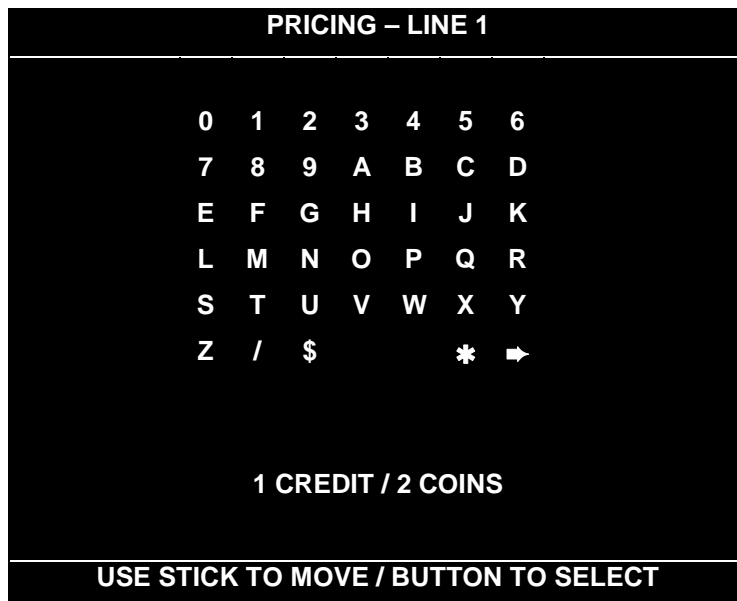

SCREEN MESSAGE ENTRY MENU (PRICING - LINE 1)

After you complete your message, you may edit it by reentering the Screen Message Entry Menu. To reenter the menu, choose EDIT from the Custom Pricing Menu.

Main Menu (continued)
Adjustments Menu (continued)
Pricing Menu (continued)
Custom Pricing Menu (continued)
Save Pricing Scheme

Save Pricing Scheme

Exiting from the Screen Message Entry Menu invokes the Save Pricing Scheme Menu. The Save Pricing Scheme Menu allows you to save your pricing scheme.

Highlight an option with any player panel joystick. Select YES to save, or NO to delete your pricing scheme.

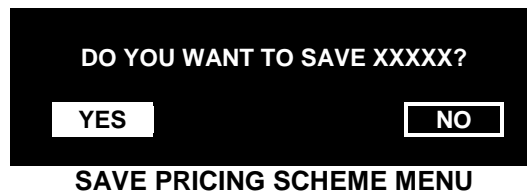

To use the new pricing scheme, you must now select it. The program returns you to the Custom Pricing Menu. You'll notice a few more entries on the menu. Besides ADD and EXIT, you'll see that you can now EDIT or SELECT a pricing scheme.

Highlight SELECT with any player panel joystick. To use your pricing scheme, press any player panel button. The program acknowledges your pricing scheme choice and returns you to Custom Pricing Menu. Choose EXIT to return to the Pricing Menu.



Main Menu (continued)
Adjustments Menu (continued)
Free Play Menu

Free Play

Select FREE PLAY at the Adjustments Menu. Free play is a useful feature for promotions and long-term testing under play conditions. Enable free play to allow players to play the game without inserting currency. Disable free play to sell games.

Highlight an option with any player panel joystick. Select the option with any player panel button.

Main Menu (continued)
Adjustments Menu (continued)
Attract Sound Menu

Attract Sound

Select ATTRACT SOUND at the Adjustments Menu. The Attract Mode operates between games. It attempts to lure prospective players into trying your game. Attract Mode sound may not be appropriate for some locations. The Attract Sound Menu allows you to enable or disable the Attract Mode sound feature. You can turn Attract Mode sound on or off without changing the game volume level.

Highlight an option with any player panel joystick. Select the option with any player panel button.

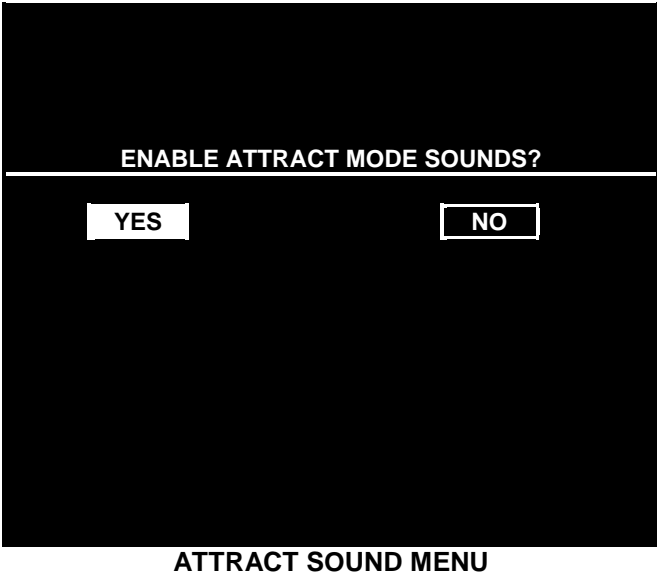

	<p>NOTICE: After you enable Attract Mode sound, you can adjust the Attract Mode volume level. See the Main Menu.</p>
---	---

Main Menu (continued)
Adjustments Menu (continued)
Additional Adjustments Menu

ADDITIONAL ADJUSTMENTS

Select ADDITIONAL ADJUSTMENTS at the Adjustments Menu. Additional Adjustments menu items allow you to set the game to match player requirements. These adjustments affect speed, challenge, rewards, etc. that determine player enjoyment.

Highlight an option with any player panel joystick. Select the option with any player panel button.



ADDITIONAL ADJUSTMENTS MENU

Game Difficulty allows you to alter the challenge that a game poses to players. Choose the level that most closely matches the players' skills.

Discount Price / Credits adjusts the quantity of buy-in points to encourage multiple game purchases.

Clock Speed alters how much game time that a player can purchase for one credit. Choose one of these settings: Extra slow, slow, medium, fast or extra fast.

Free Games and Free Quarters. Use these features to provide incentives to good players.

Violence. You can remove violence from the game without affecting other game play characteristics.

Bad Language. You can remove rough language without affecting other game play characteristics.

Clear Player Records allows you to delete stored game play data.

Tournament Mode, when enabled, adapts your game's scoring for tournament-style play.

Attract Movie Sound, when enabled, allows Attract Mode movie sound with Attract Mode sound off. The Attract Mode movie is only one component of the Attract Mode graphics.

Main Menu (continued)
Adjustments Menu (continued)
Full Factory Restore Menu

FULL FACTORY RESTORE

Select FULL FACTORY RESTORE at the Adjustments Menu. The Full Factory Restore menu allows you to clear all memory counters at once.

Highlight an option with any player panel joystick. Select the option with any player panel button.



FULL FACTORY RESTORE MENU

	<p>NOTICE: Examine and record audit information before you make changes. Once you've cleared the counters, you can't retrieve previous data from the system.</p>
---	---

Examine and record utility values before you make changes. If you choose YES, the system restores all adjustments and audits to factory default values. This change isn't reversible. The system can't restore the previous values. With the settings restored, the system displays the Reset Complete Menu.

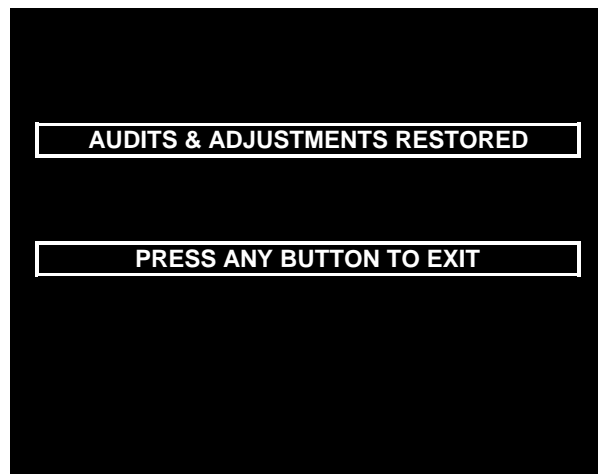

RESET COMPLETED MENU

Main Menu (continued)

Set Volume Level Menu

SET VOLUME LEVEL

Select VOLUME LEVEL at the Main Menu. The Set Volume Level Menu appears, and music plays continuously.

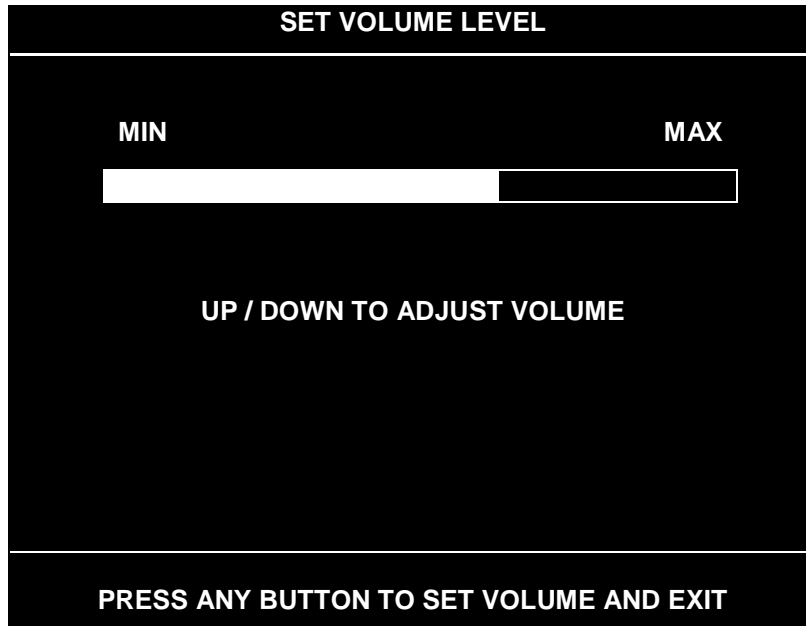

Raise or lower the game's sound level with any player panel joystick. (You can also use the volume up/down buttons on the diagnostic switch bracket.) Save your change and return to the Main Menu by pressing any player panel button.



SET VOLUME LEVEL MENU

Loud games attract more player interest than games with low-level sound.

You can turn Attract Mode sound on or off without changing the game volume level. (See *Adjustments*.)

	NOTICE: Sound level adjustments affect the volume of tests as well as of game play. If you set volume levels to minimum (zero), the speakers are silent during audio tests. We recommend setting volume levels to a moderately high value whenever you perform sound tests. After you complete tests, you may return sound levels to previous settings.
	NOTICE: You can also change the volume level during Game Mode. Press VOLUME UP or VOLUME DOWN as necessary until you achieve the desired volume. These buttons are inside the coin door.

Main Menu (continued)

Set Attract Volume Level Menu

SET ATTRACT VOLUME LEVEL

Select ATTRACT VOLUME LEVEL at the Main Menu. You must enable Attract Mode sound before setting the Attract Mode volume level. (You can enable Attract Sound from the Adjustments Menu.)

When you display the Set Attract Volume Level Menu, music plays continuously. Raise or lower the game's Attract Mode sound level with any player panel joystick. (You can also use the volume up/down buttons on the diagnostic switch bracket.) Save your change and return to the Main Menu by pressing any player panel button. Your setting won't affect the game play sound level.

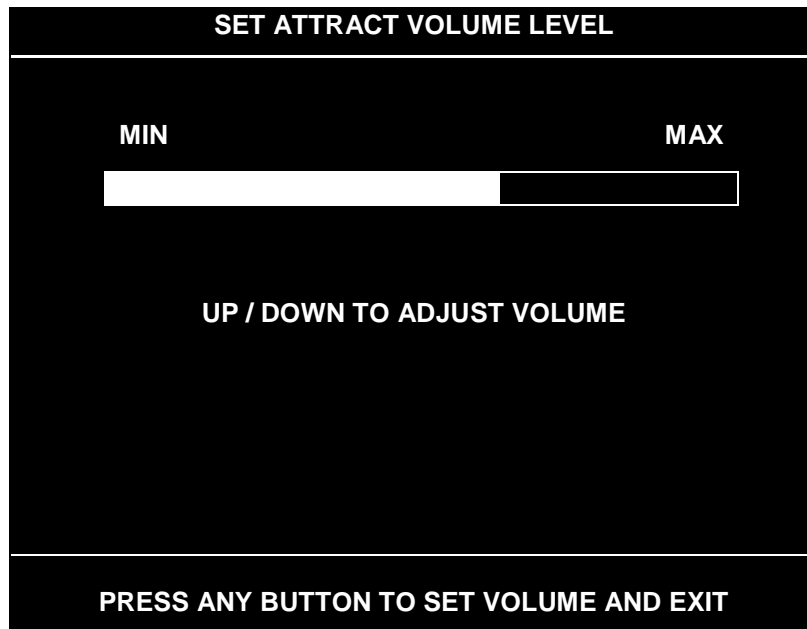

SET ATTRACT VOLUME LEVEL MENU

A loud Attract Mode encourages player interest. You can turn Attract Mode sound on or off without changing the game volume level. (See *Adjustments*.)

Main Menu (continued)

Utilities Menu

UTILITIES

Select UTILITIES at the Main Menu. Utilities Menu items allow you to clear bookkeeping totals. From the Utilities Menu, you can also restore game adjustments to factory settings.

Highlight an option with any player panel joystick. Select the option with any player panel button.



UTILITIES MENU

Dump Audits allows you to send data to the game computer's serial port. You can connect a serial printer to make a paper record of your audit data.

Clear Credits opens a menu that allows you to zero the game's credit data. Examine and record audit information before you make changes.

Clear Audits opens a menu that allows you to zero the game's audit data.

Reset High Scores permits you to delete player names and scores that appear in the Attract Mode. This feature may be useful if players insert inappropriate language into the high score table.

Default Adjustments opens a menu that allows you to reset game adjustments to factory settings.

Full Factory Restore allows you to reset game adjustments and audits to factory settings.





NOTICE: Be careful when clearing audit information. Once you clear data, you can't restore it.

NBA SHOWTIME GOLD EDITION / NFL BLITZ 2000 GOLD EDITION CONVERSION KIT

CHAPTER FOUR

DIAGNOSTIC, AUDIT & ADJUSTMENT MENU SYSTEM FOR *NBA SHOWTIME* GAMES

	<p>NOTICE: Information in this manual is subject to change without notice. Midway reserves the right to make improvements in equipment as progress in engineering warrants.</p>
	<p>NOTICE: GAME-SELECTION SWITCH. Select <i>NBA Showtime</i> or <i>NFL Blitz</i> by flipping switch 8 at DIP bank U13. Then power down and up again. After you change the game play, you must change game artwork.</p>

MENU SYSTEM

WHAT IS THE MENU SYSTEM?

The game's Menu System is a series of auditing, game adjustment and diagnostic screens. We call these screens *menus*, because they present options in menu-like lists. You can easily access and apply menus to optimize game performance. For instance...

- Use game audits menus to assess game performance.
- Use adjustment menus to help you to customize game performance. For instance, you can restore factory default game settings. You can also calibrate player controls for accuracy.
- Use diagnostic menus to verify proper equipment operation.

ACTIVATING THE MENU SYSTEM

Open the coin door. Find the TEST MODE switch inside. Press TEST MODE to invoke the Menu System. The game system responds by exiting Game Mode and entering Diagnostic Mode. You can also invoke the Menu System by turning on DIP bank U12, switch 8. (To reenter Game Mode, turn off switch 8.)

AUTOMATIC TESTS

In Diagnostic Mode, the Power-On Self-Test (POST) activates. This routine runs automatically. It can detect faults that cause game or Menu System malfunctions. POST usually takes less than a minute. The test doesn't display anything. Instead, the system boot loader indicates the software revision number and serial numbers. The system boot loader also displays a sound-loading message and other useful information.

At the end of POST, the system displays the Control Functions Menu.

CONTROL FUNCTIONS

The Control Functions Menu is purely informational. It appears for five seconds. Then the Menu System automatically displays the Dual Game Adjustment Menu.

The Control Functions Menu introduces the menu navigation controls. The key point is that you can use either player or diagnostic controls to navigate menus. Diagnostic control switches are particularly helpful when you must troubleshoot player switches. This manual discusses the controls in more detail in this chapter's *Main Menu* section. Also see the page on the menu that interests you.

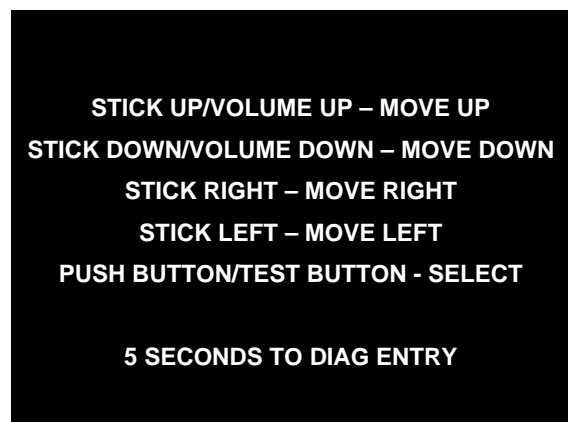

CONTROL FUNCTIONS MENU

DUAL GAME ADJUSTMENT MENU

The Dual Game Adjustment Menu is another informational, read-only menu. It appears until you choose to exit. This menu reminds you that some *NBA* settings also affect *NFL* game play. Press any button to exit to the Main Menu.

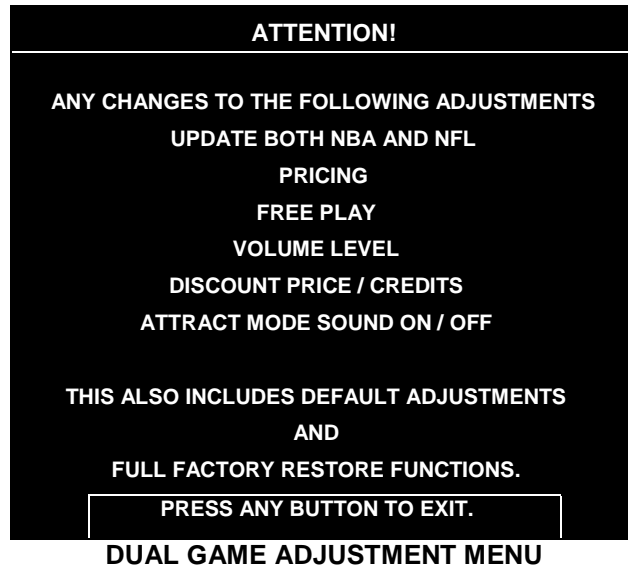

MAIN MENU

The Main Menu offers you access to the game machine's test, bookkeeping and programmable features. Game audits, adjustments and diagnostics are line items on the Main Menu. Selecting an item opens its submenu. Every submenu presents various options that you may act upon.



MENU LAYOUT

Menus differ, but related information tends to occupy the same menu locations.

- The block at the top, center of each menu displays the current menu title.
- Data (menu items, video signals, statistics, reports, etc.) appears in the center of the menu.
- Messages (explanations, control functions, revision levels) display at the bottom of the menu.

MENU NAVIGATION CONTROLS

Use any player panel joystick to highlight a desired menu item. *You can only select one highlighted item at a time.* To select a highlighted item, press any player panel button. Operator control buttons inside the

coin door serve as backup menu navigation controls. Press VOLUME UP or VOLUME DOWN buttons to highlight a menu item. Press TEST MODE to select a highlighted item.

EXIT OPTIONS

To exit the NBA menus and simultaneously enter the NFL menus, choose NFL MAIN MENU. To return the game to play, highlight either EXIT TO NFL or EXIT TO NBA. Your choice determines the game that will boot. Next, press any button.

	NOTICE: This manual depicts some menus as having two pages. Your video game machine may present these same menus as one-pagers. Monitor resolution affects whether a menu has a second screen.
---	---

Main Menu (continued)
Diagnostics Menu

DIAGNOSTICS

Select DIAGNOSTICS at the Main Menu. Diagnostic tests allow you to verify the condition of the electrical and electronic hardware in the game.

Highlight a test with any player panel joystick. Select the option with any player panel button.

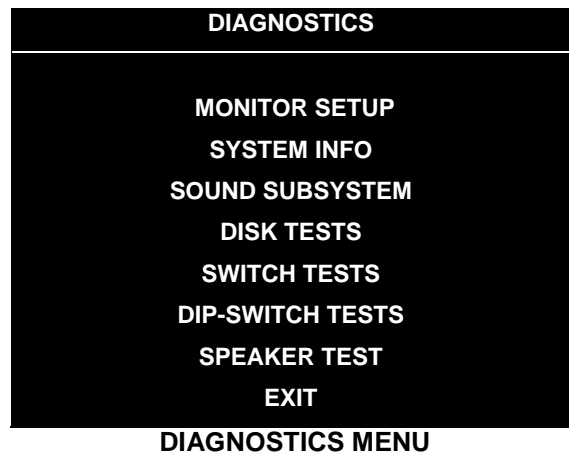

Diagnostic tests assist you in checking and adjusting the game's major systems. By running diagnostics, you can gain an insight into both system hardware and game software. Periodically running diagnostics is a crucial part of maintaining game performance and player satisfaction. Sometimes you can improve game performance by running a diagnostic test and making appropriate adjustments.

Main Menu <i>(continued)</i>
Diagnostics Menu <i>(continued)</i>
Monitor Setup Menu

MONITOR SETUP

Select MONITOR SETUP at the Diagnostics Menu. The Monitor Patterns routine provides test screens to verify monitor performance or make adjustments.

Highlight an option with any player panel joystick. Select the option with any player panel button.



MONITOR SETUP MENU

Color Bars fills the screen with colored stripes. Use the color bars to help you to check or adjust monitor brightness and contrast. The color bars also expose defects in horizontal linearity. Each color bar consists of 32 intensity levels. On a properly adjusted monitor, the top 31 of these levels are visible. Each bar should appear sharp, clear and distinct from bars on either side. Incorrect adjustment can cause missing detail at the top or bottom of a bar. Bent bars indicate horizontal linearity flaws, such as pie crust, pincushion or barrel distortion. *(Correct color bar colors, left to right: Red, Green, Blue, Black, White, Cyan, Yellow, Violet.)* Set controls as follows: 1. Adjust BRIGHTNESS and CONTRAST to minimum. 2. Turn up BRIGHTNESS until the pixels in the black stripe begin to glow (turn dark gray). 3. Bring up the CONTRAST control until you can see 31 bars.

Crosshatch Patterns fill the screen with a grid and a series of dots. Crosshatch Patterns help you to check or adjust several monitor parameters: These include convergence, linearity, active viewing area and dynamic focus. The grid and the dots should be all white in color, with no fringes or parallel images. The lines should be straight and the dots round. For more detail on these adjustments, consult service literature from the monitor manufacturer.

Color Screen tests fill the screen with 100% of the chosen color at normal intensity. The Color Screen tests help you to check or adjust monitor intensity, black level, blanking and color purity. Each screen should be absolutely uniform from top to bottom and side to side. No retrace lines or noise should be visible. Color Screens may not hold their uniformity if the monitor degaussing circuit is defective.

White, Gray and Black Screens fill the screen with black, gray or white at various intensities. These monochrome screens help you to check or adjust monitor convergence, purity, contrast and intensity. These screens also simplify black level and color gun control settings. The screens should be uniform with no color tints or distortion. No retrace lines or noise should be visible.

If tests indicate a need for adjustment, use controls on the Monitor Remote Adjustment Board.

Main Menu (continued)
Diagnostics Menu (continued)
System Information Menu

SYSTEM INFORMATION

Select SYSTEM INFO at the Diagnostics Menu. The System Information Menu provides the current version numbers of this game’s hardware and software. Use these numbers to describe the system during parts replacement, service calls, etc.

Highlight an option with any player panel joystick. Select the option with any player panel button.



The System Information menu reports information, but doesn’t permit you to make changes. The Title line identifies the manufacturer of this game and the electronic board set used in this product. The Serial Number, Game and Date of Manufacture identify the game name and production run.

Main Menu (continued)
Diagnostics Menu (continued)
Sound Subsystem Menu

SOUND SUBSYSTEM TEST

Select SOUND SUBSYSTEM at the Diagnostics Menu. Sound Subsystem Tests verify that audio components are connected and operate properly.

Highlight an option with any player panel joystick. Select the option with any player panel button.

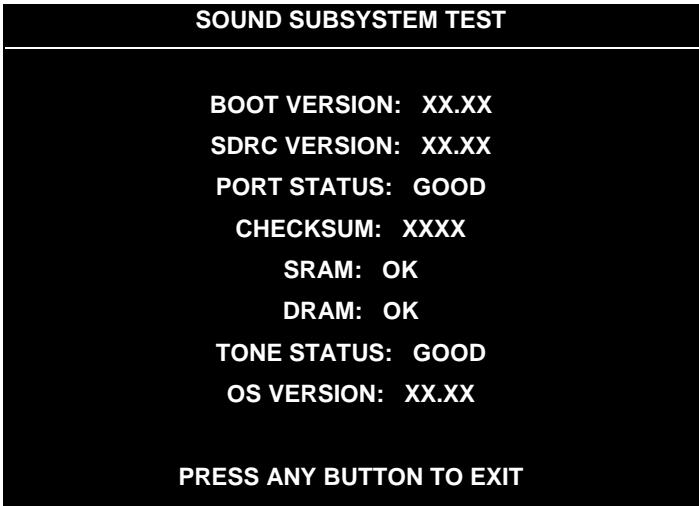

SOUND SUBSYSTEM MENU

Version, Status, Checksum and RAM Reports are diagnostic routines. These routines analyze the digital sound circuits and can detect sound memory problems. Test results appear as numbers or messages. Sounds may also accompany some tests. Reports other than GOOD or OK indicate a problem.

Main Menu (continued)
Diagnostics Menu (continued)
Disk Tests Menu

DISK TESTS

Select DISK TESTS at the Diagnostics Menu. Disk Tests allow you to verify proper operation of the hard disk drive assembly.

Highlight an option with any player panel joystick. Select the option with any player panel button.

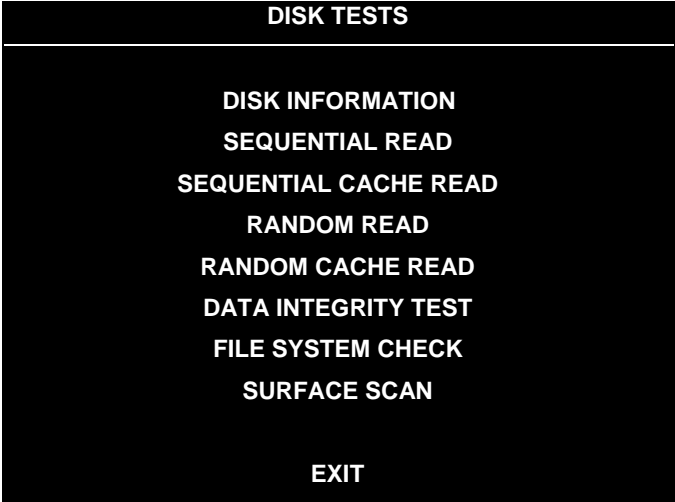

DISK TESTS MENU

Disk Information. The Disk Information routine verifies the interface between the CPU Board Assembly and hard disk drive. The processor requests disk information. Data cannot be retrieved successfully if there is a problem.

Sequential Read. This routine tries to access every bit of data in the order it is stored directly on the disk. The hard disk drive media may be defective if this routine cannot be completed successfully.

Sequential Cache Read. This routine tries to access every bit of data in the order it is stored in the temporary disk memory cache. If this test is not successful, the memory circuits may be faulty.

Random Read. This routine tries to access every bit of data in no particular order directly from the disk. This test may detect problems with ability to position the drive heads accurately over the requested data.

Random Cache Read. This routine tries to access every bit of data in no particular order from the temporary disk memory cache. If the cache fails this test, memory circuits may contain a fault.

Data Integrity Test. This test analyzes the data on the disk drive. The test determines if corrupted data is on the disk. Bad data can cause the program to falter even though the hard disk operates correctly.

File System Check. This routine performs a file-by-file check of the data stored on the hard disk.

Surface Scan. The magnetic material on the disk can become damaged, causing data to be unreadable. This routine locates unusable areas on the disk and marks them for future reference.

Main Menu (continued)
Diagnostics Menu (continued)
Switch Tests Menu

SWITCH TESTS

Select SWITCH TESTS at the Diagnostics Menu. Switch Tests verify proper operation of the game's switches, including buttons and joystick switches.

Activate each switch, and the indicator on the menu changes state. Release the switch and the indicator returns to its previous, normally open or closed condition. You can test any combination of switches together. To exit the test, simultaneously press the middle two control buttons inside the coin door. The Switch Test Menu refers to these buttons as "volume buttons."

PLAYER SWITCH INPUTS TEST							
P1	UP	■	P3	UP	■	LEFT COIN	■
P1	DOWN	■	P3	DOWN	■	RIGHT COIN	■
P1	LEFT	■	P3	LEFT	■	P1 START	■
P1	RIGHT	■	P3	RIGHT	■	SLAM/TILT	■
P1	SHOOT	■	P3	SHOOT	■	TEST	■
P1	PASS	■	P3	PASS	■	P2 START	■
P1	TURBO	■	P3	TURBO	■	SERVICE CREDIT	■
P2	UP	■	P4	UP	■	CENTER COIN	■
P2	DOWN	■	P4	DOWN	■	EXTRA COIN	■
P2	LEFT	■	P4	LEFT	■	P3 START	■
P2	RIGHT	■	P4	RIGHT	■	P4 START	■
P2	SHOOT	■	P4	SHOOT	■	VOLUME DOWN	■
P2	PASS	■	P4	PASS	■	VOLUME UP	■
P2	TURBO	■	P4	TURBO	■	BILL VALID.	■
P1 49 WAY		P2 49 WAY		P3 49 WAY		P4 49 WAY	
24		24		24		24	
PRESS BOTH PLAYER 1 AND PLAYER 2 START BUTTONS TO EXIT							

SWITCH TEST MENU

Switches appear on the menu as colored boxes. Red boxes indicate an open state. Green indicates closed. Any other color indicates a fault condition. A single indication on the menu should exactly duplicate a button or joystick change. You'll notice a unique number for a switch recognized by game electronics.

Use Switch Tests to locate crossed wires, intermittent conditions and stuck switches.

	<p>NOTICE: Some switches may not be used with this game. If you can't find one of the listed switches, check the wiring diagram.</p>
---	---

Main Menu (continued)
Diagnostics Menu (continued)
DIP Switch Tests Menu

DIP-SWITCH TESTS

Select DIP-SWITCH TESTS at the Diagnostics Menu. Two 8-position DIP switch banks reside on the SIO Board. DIP-Switch Tests allow you to check the position of the 16 switches in these banks. You can change the setting of any DIP switch without removing the circuit board cage.

The menu displays an illustration of each switch block and the current settings. You can change DIP-switch positions with power on. Set any switch, and then check the menu to verify that the new setting is enabled.

Refer to the charts for assistance in choosing switch positions. (* indicates factory defaults.) To exit the DIP-switch Test, press the left control button (inside the coin door).

Game-Selection Switch. Select *NBA Showtime* or *NFL Blitz* by flipping switch 8 at DIP bank U13. Then power down and up again. After you change the game play, you must change game artwork.

DIP Switch 1 (U13)		SW1	SW2	SW3	SW4	SW5	SW6	SW7	SW8
Coinage Control	DIP Switch CMOS	Off On*							
USA1	Ger1 Fr ECA1 UK1		Off*	Off*	Off*				
USA2	Ger2 Fr ECA2 UK2		On	Off	Off				
USA3	Ger3 Fr ECA3 UK3		Off	On	Off				
USA4	Ger4 Fr ECA4 UK4		On	On	Off				
USA5	Ger5 Fr ECA5 UK5		Off	Off	On				
USA9	Ger9 Fr ECA9 UK9		On	Off	On				
USA10	Ger10 Fr ECA10 UK ECA		Off	On	On				
USA	ECA / Ger ECA / Fr ECA8		On	On	On				
Free Play	(All Countries)		On	On	On				
Country	USA France Germany UK**					Off* On Off On	Off* Off On On		
Game Selection	By player By Switch 8							Off* On	
Game at power up	NBA Showtime NFL Blitz								Off* On

**Except Free Play, which is "on" for SW2 through SW6.

DIP Switch 2 (U12)		SW1	SW2	SW3	SW4	SW5	SW6	SW7	SW8
Joystick Type	8-Way 49-Way	Off On*							
Monitor Resolution	Medium Res Low Res		Off* On						
Unused	-- --			Off On					
Unused	-- --				Off On				
Unused	-- --					Off On			
Player Panel Type	2-Player 4-Player						Off On*		
Power Up Test	Active Inactive							Off On*	
Operating Mode	Game Mode Test Mode								Off* On

Main Menu (continued)
Diagnostics Menu (continued)
Speaker Test Menu

SPEAKER TEST

Select SPEAKER TEST at the Diagnostics Menu. The Speaker Test provides audio signals to test the loudspeakers.

Use tests on the Speaker Test menu to verify operation of audio system components. Highlight an option with any player panel joystick. Select the option with any player panel button.

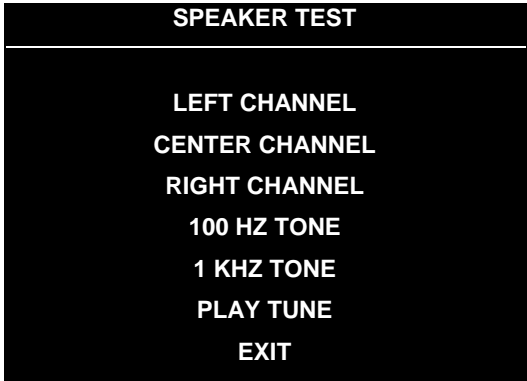

SPEAKER TEST MENU

Channel and Tone Tests. The channel subtests employ voice announcements to verify speaker locations. Use the 100 Hz tone to check the speakers’ bass response. Small speakers with weak magnets or poor baffles may cause poor bass response.

Play Tune repeats a series of game sounds. Use PLAY TUNE to check speaker operation and fidelity. If your game has stereo speakers, run PLAY TUNE and test speaker phasing. Muddy, weak or distorted sound during this test may indicate crossed wires or out-of-phase speaker connections. Missing sounds may indicate audio cabling errors.

	<p>NOTICE: Check the volume setting before testing. To test the speakers thoroughly, increase the volume level. Before returning to Game-Over Mode, reset the volume level to its original setting.</p>
--	--

Main Menu (continued)

Audits Menu

AUDITS

Select AUDITS at the Main Menu. The Audits menus permit you to review game play statistics. Additional menus give detailed reports for each player position on game starts, ends, cabinet abuse, fault conditions, etc.

Highlight an option with any player panel joystick. Select the option with any player panel button. The menu displays a list of the statistics available to you. Select an item to view the detailed report.



AUDITS MENU

Data in the Audits menus helps you to keep records of the game's popularity and earning potential. Use the highlight bar to select the desired subject on the Audits Menu. Each entry on the Audits Menu is the subject for an entire menu of bookkeeping information. On these menus, you can track favorite teams, frequently used offensive and defensive plays, etc.

Some audits menus also include histograms. Histogram menus allow graphical analysis of statistics. This permits visual comparisons between games. Histograms have no bar graphs until the system acquires enough data to plot.

Examine and record all game audit values before performing game service or repairs.



NOTICE: Be careful when clearing audit information. Once you clear data, you cannot restore it.

Main Menu (continued)
Audits Menu (continued)
Coin Audits Menu

COIN AUDITS

Select COIN AUDITS at the Audits Menu. The Coin Audits menu permits you to assess the currency collection. This report menu presents revenue quantities and other important game statistics. Coin Audits is a read-only menu.

To exit, press any player panel button.

COIN AUDITS - PAGE: 1	
LEFT SLOT COINS	XXXXXXXX
RIGHT SLOT COINS	XXXXXXXX
BILLS	XXXXXXXX
CENTER SLOT COINS	XXXXXXXX
EXTRA SLOT COINS	XXXXXXXX
GAME STARTS	XXXXXXXX
MID-GAME STARTS	XXXXXXXX
CONTINUES	XXXXXXXX
CHALLENGER ACCEPTED	XXXXXXXX
FREE QUARTERS AWARDED	XXXXXXXX
FREE GAMES AWARDED	XXXXXXXX
SERVICE CREDITS	XXXXXXXX
UP – NEXT / BUTTON - EXIT	
COIN AUDITS MENU	

The Coin Audits menu reports total quantities of coins, bills or credits collected by each active device. The menu doesn't calculate the value of the collected currency.

This menu reports information, but doesn't permit you to make changes. To reset the coin, bill and credit counters to zero, use the Clear Audits menu.

We recommend that you examine and record audit information before you make changes. Once you've cleared the counters, you can't retrieve the previous data from the system.

COIN AUDITS – PAGE: 2	
TOTAL PLAYS	XXXXXXXX
TOTAL PAID CREDITS	XXXXXXXX
TOTAL	XXXXXXXX
DOWN - PREV / BUTTON - EXIT	
COIN AUDITS MENU, PAGE 2	

Main Menu (continued)
Audits Menu (continued)
Credits Audits Menu

CREDITS AUDITS

Select CREDITS AUDITS at the Audits Menu. The Credits Audits menu permits you to assess the currency collection. This report menu presents revenue quantities and other important game statistics. Credits Audits is a read-only menu.

To exit, press any player panel button.

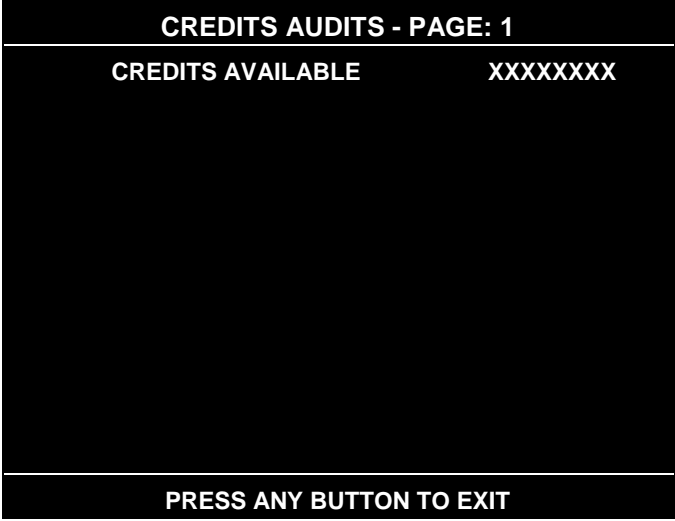

CREDITS AUDITS MENU

Main Menu (continued)
Audits Menu (continued)
Game Audits Menu

GAME AUDITS

Select GAME AUDITS at the Audits Menu. The Game Audits menus permit you to review the game play statistics. Game Audits is a read-only menu.

To exit, press any player panel button.

GAME AUDITS - PAGE: 1			
MACHINE POWER-ON	XX	WENT INTO OVERTIME 1	XX
TOTAL UPTIME	XX	WENT INTO OVERTIME 2	XX
TOTAL PLAYTIME	XX	WENT INTO OT 3	XX
GAMES STARTED	XX	1 PLAYER FINISHES	XX
INITIALS ENTERED	XX	2 PLAYER FINISHES	XX
<FG> PURCHASED AT START	XX	3 PLAYER FINISHES	XX
CREATE PLAYER SESSIONS	XX	4 PLAYER FINISHES	XX
1 PLAYER	XX	2P V CPU FINISHES	XX
2 PLAYER	XX	H VS H LSW'S	XX
3 PLAYER	XX	CPU WINS (FG)	XX
4 PLAYER	XX	AVG H VS H TOTAL SCORE (FG)	XX
2P V CPU	XX	AVG H VS CPU TOTAL SCORE (FG) AVG	XX
1 QUARTER GAMES	XX	AVG H VS H WIN SCORE (FG)	XX
2 QUARTER GAMES	XX	AVG H VS H LOSS SCORE (FG)	XX
3 QUARTER GAMES	XX	BIGGEST CPU WIN MARGIN (FG)	XX
4 QUARTER GAMES	XX	BIGGEST CPU LOSS MARGIN (FG)	XX
	XX		
	XX		
	XX		
	XX		
	XX		
	XX		

GAME AUDITS MENU

The Game Audits menu reports information, but doesn't permit you to make changes. Examine and record information at GAME AUDITS before deleting data at the Clear Audits Menu. Once you've cleared the counters, you can't retrieve the previous data from the system.

GAME AUDIT MENU TERMS

TERM	DEFINITION	TERM	DEFINITION
AVG	Average	LSW	Your game computer's internal record-keeping counters
CPU	Central Processing Unit: The game computer	Machine Power-On	Number of power cycles (game turn-ons)
<FG>, (FG)	Full Game	OT	Overtime
H VS CPU	Human versus CPU: Competition that pits players against the game computer	PV	Player versus...
H VS H	Human versus human: Competition between human players	Total Uptime	Overall on-time for the game computer
		2PV	Two players versus...

Main Menu (continued)
Audits Menu (continued)
Team Stats Menu

TEAM STATS

Select TEAM STATS at the Audits Menu. The Team Stats Menu details the number of games played by each team in the league. Team Stats is a read-only menu.

To exit, press any player panel button.

TEAM STATS – PAGE: 1			
ATLANTA HAWKS	0%	NEW JERSEY NETS	0%
BOSTON CELTICS	0%	NEW YORK NICKS	0%
CHARLOTTE HORNETS	0%	ORLANDO MAGIC	0%
CHICAGO BULLS	0%	PHILADELPHIA 76ERS	0%
CLEVELAND CAVALIERS	0%	PHOENIX SUNS	0%
DALLAS MAVERICKS	0%	PORTLAND TRAILBLAZERS	0%
DENVER NUGGETS	0%	SACRAMENTO KINGS	0%
DETROIT PISTONS	0%	SAN ANTONIO SPURS	0%
GOLDEN STATE WARRIORS	0%	SEATTLE SUPERSONICS	0%
HOUSTON ROCKETS	0%	TORONTO RAPTORS	0%
INDIANAPOLIS PACERS	0%	UTAH JAZZ	0%
LOS ANGELES CLIPPERS	0%	VANCOUVER GRIZZLIES	0%
LOS ANGELES LAKERS	0%	WASHINGTON WIZARDS	0%
MIAMI HEAT	0%		
MILWAUKEE BUCKS	0%		
MINNESOTA TIMBERWOLVES	0%		

PRESS ANY BUTTON TO EXIT

TEAM STATS MENU

Main Menu (continued)
Audits Menu (continued)
Game Features Menu

GAME FEATURES

Select GAME FEATURES at the Audits Menu. Game Features tracks play statistics that relate characters in the game and game play. Game Features is a read-only menu.

To exit, press any player panel button.

GAME FEATURES – PAGE: 1			
NUMBER OF PLAYER RECORDS	0	CREATP CUSTOM UNIFORM	0
NUMBER OF LRU RECORDS	0	CREATP TEAM UNIFORM	0
RECORDS FROM CREATE PLAYER	0	CREATP NICKNAME	0
NUMBER OF PLAYER FIRE	0	CREATP AVG HEIGHT PTS	0
AVG PTS PLAYER FIRE	0	CREATP AVG WEIGHT PTS	0
NUMBER OF TEAM FIRE	0	CREATP AVG PWR PTS	0
AVG PTS TEAM FIRE	0	CREATP AVG SPEED PTS	0
NUMBER OF ALLEY OOPS	0	CREATP AVG TWOPTS PTS	0
NUMBER OF DOUBLE DUNKS	0	CREATP AVG STEAL PTS	0
CREATP MASCOT HEADS	0	CREATP AVG BLOCK PTS	0
CREATP NBA HEADS	0	CREATP AVG DUNK PTS	0
CREATP FEMALE HEADS	0	CREATP AVG DRIBBLE PTS	0
CREATP UM HEADS	0	PRIV1	0
CREATP MID HEADS	0	PRIV2	0
CREATP OTHER HEADS	0	PRIV3	0
CREATP DEFAULT UNIFORM	0	PRIV4	0
		PRIV5	0
		PRIV6	0
		PRIV7	0

UP – NEXT / BUTTON - EXIT

GAME FEATURES MENU, PAGE 1

Number Of Player Records. Number of player initial sets entered in CMOS RAM.

Number Of LRU Records. Number of record slots (space for player data) left in CMOS RAM.

Records From Create Player. Number of player records produced in Create Player Mode.

Number Of Player Fire. Number of times a player has started on fire.

Avg Pts Player Fire. Average number of points that player scored while player was on fire.

Number Of Team Fire. Number of times that the team has started on fire.

Avg Pts Team Fire. Average number of points that the team scored while it was on fire.

Number Of Alley Oops. Total number of alley oops performed.

Number Of Double Dunks. Total number of double dunks performed.

Creatp Mascot Heads. Number of player-created characters with mascot heads.

Creatp NBA Heads. Number of player-created characters with NBA-personality heads.

Creatp Female Heads. Number of player-created characters with female heads.

Creatp UM Heads. Number of player-created characters with Universal Studios® monster heads.

Creatp Mid Heads. Number of player-created characters with Midway Games® heads.

Creatp Other Heads. Number of player-created characters with custom heads.

Creatp Default Uniform. Number of player-created characters with the selected team's uniforms.

Creatp Custom Uniform. Number of player-created characters with custom uniforms.

Creatp Team Uniform. Number of player-created characters with specific team uniforms.

Creatp Nickname. Number of player-created characters with nicknames.

Creatp Avg Height Pts. Average height attribute setting.

Creatp Avg Weight Pts. Average weight attribute setting.

Creatp Avg Pwr Pts. Average power attribute setting.

Creatp Avg Speed Pts. Average speed attribute setting.

Creatp Avg TwoPts Pts. Average two-point shot attribute setting.

Creatp Avg Steal Pts. Average stealing attribute setting.

Creatp Avg Block Pts. Average blocking attribute setting.

Creatp Avg Dunk Pts. Average dunking attribute setting.

Priv1. Number of times player-created characters include privilege 1 (a player selection).

Priv2. Number of times player-created characters include privilege 2 (a player selection).

Priv3. Number of times player-created characters include privilege 3 (a player selection).

Priv4. Number of times player-created characters include privilege 4 (a player selection).

Priv5. Number of times player-created characters include privilege 5 (a player selection).

Priv6. Number of times player-created characters include privilege 6 (a player selection).

Priv7. Number of times player-created characters include privilege 7 (a player selection).

Priv8. Number of times player-created characters include privilege 8 (a player selection).

Game With Creatp. Number of games played with player-created characters.

Win V CPU With Creatp. Number of player-won games with player-created characters.

Win V Human With Creatp. Number of computer-won games with player-created characters.

Tournament Games. Number of games played in Tournament-Scoring Mode.

Timer Level. Speed at which game machine produces time-released and created characters.

TLF's. A counter employed by designers (has no purpose in the field).

SBLF's. A counter employed by designers (has no purpose in the field).

Highlight an option with any player panel joystick. Select the option with any player panel button.

GAME FEATURES – PAGE: 2

PRIV4	0
PRIV5	0
PRIV6	0
PRIV7	0
PRIV8	0
GAME WITH CREATP	0
WIN V CPU WITH CREATP	0
WIN V HUMAN WITH CREATP	0
TOURNAMENT GAMES	0
TIMER LEVEL	0
TLF'S	0
SBLF'S	0

DOWN – PREV / BUTTON - EXIT

GAME FEATURES MENU, PAGE 2

Main Menu (continued)
Audits Menu (continued)
Exception Dump Menu

EXCEPTION DUMP

Select EXCEPTION DUMP at the Audits Menu. Game programmers use the Exception Dump Menu to view register contents during program development. This menu has no field purpose. Exception Dump is a read-only menu.

To exit, press any player panel button.

Main Menu (continued)
Audits Menu (continued)
Clear Audits Menu

CLEAR AUDITS

Select CLEAR AUDITS at the Audits Menu. The Clear Audits menu allows you to clear individual memory counters or to reset them all at once.

Highlight an option with any player panel joystick. Select the option with any player panel button.



You can reset any audit menu from the Clear Audits Menu. Choose an item and zero its counter. CLEAR ALL simultaneously changes all audit categories to factory default values. After you've selected an item, the system gives you the opportunity to escape this change. For example:

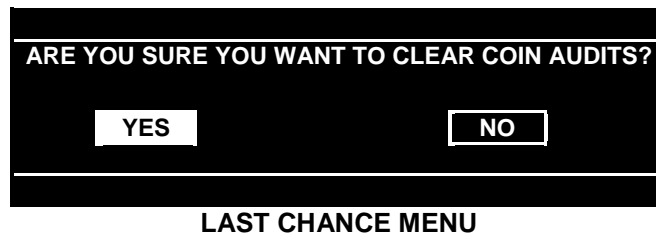

After you've selected and verified a clear function, the values reset. The system can't restore the previous values. Examine and record utility values before you make changes.

Main Menu (continued)

Adjustments Menu

ADJUSTMENTS

Select ADJUSTMENTS at the Main Menu. The Adjustments menus permit you to change game characteristics. Use these menus to optimize game performance and earnings.

Highlight an option with any player panel joystick. Select the option with any player panel button.



Main Menu (continued)

Adjustments Menu (continued)

Pricing Menu

PRICING

Select PRICING at the Adjustments Menu. The Pricing menus allow you to view current settings or change the cost of games. Custom pricing allows you to select the number of coins or credits required for each game. The game restores factory default values if you exchange the CPU Board or if the backup battery fails.

Highlight an option with any player panel joystick. Select the option with any player panel button.

You may reset options to factory defaults or change an option after viewing it. We recommend examining and recording pricing options before making changes.

You may save several custom prices and then choose between them as needed. On-screen instructions guide you through the process of creating custom price settings.

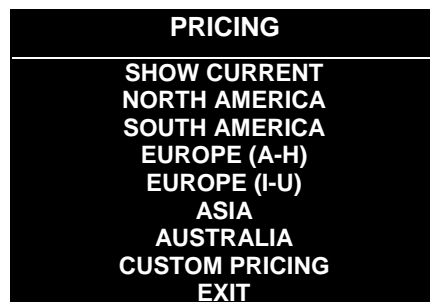

PRICING MENU

An additional box appears on screen to explain the available functions as you select each item.

STANDARD PRICING TABLE

NAME	START	CONTINUE	CREDITS/COIN	COIN 1	COIN 2	COIN 3	COIN4	BILL
ANTILLES	2	2	1/25¢, 4/1G	.25¢	1G			
AUSTRALIA 1	2	2	1/3X20¢, 2/\$1.00	.20¢	\$1.00			
AUSTRALIA 2	1	1	1/5X20¢, 1/\$1.00	.20¢	\$1.00			
AUSTRIA 1	2	2	1/5Sch, 2/10Sch	5 Sch	10 Sch			
AUSTRIA 2	1	1	1/2X5Sch, 3/2X10Sch	5 Sch	10 Sch			
BELGIUM 1	2	2	1/20BF	20BF	20BF			
BELGIUM 2	2	2	3/20BF	20BF	20BF			
BELGIUM 3	2	2	2/20BF	20BF	20BF			
BELGIUM ECA	2	2	1/20BF	50BF	20BF	5BF		
CANADA 1	2	2	1 / 2 x 25¢, 3 / \$1	25¢	25¢			
CANADA 2	2	2	1 / 2 x 25¢, 3 / \$1	25¢	\$1.00			
CANADA 3	2	2	3 / \$1.00, 6 / \$2.00	\$1.00	\$2.00			
CANADA ECA	2	2	1 / 2 x 25¢, 3 / \$1	25¢		\$1.00	\$2.00	
DENMARK	2	2	3/5DKr, 7/10DKr	5DKr	10DKr			
FINLAND	2	2	1/1Fmk	1Fmk	5Fmk			
FRANCE 1	2	2	2/5Fr, 5/10Fr	5Fr	10Fr			
FRANCE 2	2	1	2/5Fr, 4/10Fr	5Fr	10Fr			
FRANCE 3	2	1	1/5Fr, 3/10Fr	5Fr	10Fr			
FRANCE 4	2	1	1/5Fr, 2/10Fr	5Fr	10Fr			
FRANCE 5	2	1	2/5Fr, 5/10Fr, 11/2 X 10Fr	5Fr	10Fr			
FRANCE 6	2	1	2/5Fr, 4/10Fr, 9/2 X 10Fr	5Fr	10Fr			
FRANCE 7	2	1	1/5Fr, 3/10Fr, 7/2 X 10Fr	5Fr	10Fr			
FRANCE 8	2	1	1/5Fr, 2/10Fr, 5/2 X 10Fr	5Fr	10Fr			
FRANCE 9	2	1	1/3 X 1Fr, 2/5Fr	1Fr	5Fr			
FRANCE 10	2	1	1/2 X 1Fr, 3/5Fr	1Fr	5Fr			
FRANCE 11	2	1	1/3 X 1Fr, 2/5Fr, 5/2 X 5Fr	1Fr	5Fr			
FRANCE 12	2	1	1/2 X 1Fr, 3/5Fr, 7/2 X 5Fr	1Fr	5Fr			
FRANCE ECA 1	1	1	2/5Fr, 5/10Fr	1Fr	5Fr	10Fr	20Fr	
FRANCE ECA 2	1	1	2/5Fr, 4/10Fr	1Fr	5Fr	10Fr	20Fr	
FRANCE ECA 3	1	1	1/5Fr, 3/10Fr	1Fr	5Fr	10Fr	20Fr	
FRANCE ECA 4	1	1	1/5Fr, 2/10Fr	1Fr	5Fr	10Fr	20Fr	
FRANCE ECA 5	1	1	2/5Fr, 5/10Fr, 11/2 X 10Fr	1Fr	5Fr	10Fr	20Fr	
FRANCE ECA 6	1	1	2/5Fr, 4/10Fr, 9/2 X 10Fr	1Fr	5Fr	10Fr	20Fr	
FRANCE ECA 7	1	1	1/5Fr, 3/10Fr, 7/2 X 10Fr	1Fr	5Fr	10Fr	20Fr	
FRANCE ECA 8	1	1	1/5Fr, 2/10Fr, 5/2 X 10Fr	1Fr	5Fr	10Fr	20Fr	
FRANCE ECA 9	1	1	1/3 X 1Fr, 2/5Fr	1Fr	5Fr	10Fr	20Fr	
FRANCE ECA 10	1	1	1/2 X 1Fr, 3/5Fr	1Fr	5Fr	10Fr	20Fr	
FRANCE ECA 11	1	1	1/3 X 1Fr, 2/5Fr, 5/10Fr	1Fr	5Fr	10Fr	20Fr	
FRANCE ECA 12	1	1	1/2 X 1Fr, 3/5Fr, 7/10Fr	1Fr	5Fr	10Fr	20Fr	
FRANCE ECA 13	1	1	1/10Fr, 2/20Fr, 4/30Fr	1Fr	5Fr	10Fr	20Fr	
FREE PLAY	--	--	--	None	None	None	None	None
GERMANY 1	2	2	1/1DM, 6/5DM	1DM	5DM			
GERMANY 2	2	1	1/1DM, 7/5DM	1DM	5DM			
GERMANY 3	2	1	1/1DM, 8/5DM	1DM	5DM			
GERMANY 4	2	1	1/1DM, 5/5DM	1DM	5DM			
GERMANY 5	2	1	1/1DM, 6/5DM	1DM	5DM			
GERMANY ECA 1	2	2	1/1DM, 2/2DM, 6/5DM	1DM	2DM	5DM		
GERMANY ECA 2	2	1	1/1DM, 2/2DM, 6/5DM	1DM	2DM	5DM		
GERMANY ECA 3	1	1	1/1DM, 2/2DM, 6/5DM	1DM	2DM	5DM		
HUNGARY	2	2	1/2X10Ft, 3/2X20Ft	10Ft	20Ft			
ITALY	2	2	1/500Lit	500Lit	500Lit			
JAPAN 1	2	2	1/100Yen	100	100			
JAPAN 2	2	2	2/100Yen	100	100			
JAPAN 3	1	1	1/100Yen	100	100			
JAPAN 4	1	1	2/100Yen	100	100			
JAPAN 5	1	1	4/100Yen	100	100			
JAPAN 6	1	1	1/2X100Yen	100	100			
NETHERLANDS	2	2	1/1HFI, 3/2.5HFI	1HFI	2.5HFI			
NEW ZEALAND 1	1	1	1/\$1	\$1	\$2			
NEW ZEALAND 2	1	1	2/\$1	\$1	\$2			
NORWAY	2	2	3/5Nkr, 6/10Nkr	5Nkr	10Nkr			
SPAIN 1	2	2	1/100Pta, 6/500Pta	100Pta	500Pta			
SPAIN 2	2	2	1/100Pta, 5/500Pta	100Pta	500Pta			
SWEDEN	2	2	1/3X1SKr, 2/5SKr	1SKr	5SKr			
SWITZERLAND 1	2	2	1/1SFr, 6/5SFr	1SFr	5SFr			
SWITZERLAND 2	2	2	1/1SFr, 7/5SFr	1SFr	5SFr			
SWITZERLAND 3	2	2	1/1SFr, 8/5SFr	1SFr	5SFr			

(Table continues on next page)

STANDARD PRICING TABLE, *continued*

NAME	START	CONTINUE	CREDITS/COIN	COIN 1	COIN 2	COIN 3	COIN4	BILL
UK ECA 1	1	1	1/50p, 3/£1.00	£1.00	50p	20p	10p	£2.00
UK ECA 2	1	1	1/50p, 2/£1.00	£1.00	50p	20p	10p	£2.00
UK ECA 3	1	1	1/30p, 2/50p, 5/£1.00	£1.00	50p	20p	10p	£2.00
UK 4	1	1	1/50p, 3/£1.00	£1.00	50p			
UK 5	1	1	1/50p, 2/£1.00	£1.00	50p			
UK ECA 6	1	1	1/30p, 2/50p, 4/£1.00	£1.00	50p	20p	10p	£2.00
UK ECA 7	1	1	3/£1.00	£1.00	50p	20p	10p	£2.00
UK ECA 8	1	1	1/50p, 2/£1.00, 4/£2.00	£1.00	50p	20p	10p	£2.00
USA1	2	2	1/25¢	25¢	25¢			\$1.00
USA2	2	1	1/25¢	25¢	25¢			\$1.00
USA3	1	1	1/25¢	25¢	25¢			\$1.00
USA4	1	1	1/50¢, 3/\$1.00	25¢	25¢			\$1.00
USA5	2	1	1/50¢, 4/\$1.00	25¢	25¢			\$1.00
USA6	1	1	1/50¢	25¢	25¢			\$1.00
USA7	1	1	1/50¢, 3/\$1.00	25¢	25¢			\$1.00
USA8	2	2	1/50¢, 4/\$1.00	25¢	25¢			\$1.00
USA9	3	2	1/25¢, 4/\$1.00	25¢	25¢			\$1.00
USA10	3	3	1/25¢, 4/\$1.00	25¢	25¢			\$1.00
USA11	4	2	1/25¢, 4/\$1.00	25¢	25¢			\$1.00
USA12	4	3	1/25¢, 4/\$1.00	25¢	25¢			\$1.00
USA13	4	4	1/25¢, 4/\$1.00	25¢	25¢			\$1.00
USA ECA	3	3	1/25¢, 4/\$1.00	\$1.00	25¢	10¢	05¢	\$1.00

Main Menu (<i>continued</i>)
Adjustments Menu (<i>continued</i>)
Pricing Menu (<i>continued</i>)
Current Pricing Menu

Current Pricing

Select SHOW CURRENT at the Pricing Menu. The Current Pricing Menu is a read-only menu. Use it to check pricing parameters for the pricing table your game is using. To select a new pricing table, return to the Pricing Menu. To invent your own pricing table, select Custom Pricing on the Pricing Menu.

Press any START button to exit from the menu.

CURRENT PRICING	
LEFT SLOT UNITS	XX
RIGHT SLOT UNITS	XX
CENTER SLOT UNITS	XX
EXTRA SLOT UNITS	XX
BILL VALIDATOR UNITS	XX
UNITS PER CREDIT	XX
UNITS PER BONUS	XX
MINIMUM UNITS	XX
CREDITS TO START	XX
CREDITS TO CONTINUE	XX
MAX CREDITS	XX
COINS PER BILL	XX

CURRENT PRICING MENU

The following table clarifies Pricing Menu terms...

MENU TERM	DISCUSSION
Slot Units; Bill Validator (DBV) Units	Cyber-currency. This adjustment assigns a number of "units" to each coin mechanism or bill acceptor. For instance, if a quarter buys 1 unit, then \$1 buys 4 units. (<i>See Coins per Bill.</i>) You insert a coin into a 1-unit coin acceptor. The system, due to its programming, knows that your coin is worth one unit.
Units per Credit	How many units equal one credit. (Units buy credit, the price of one game.)
Units per Bonus	Units awarded when a player earns a bonus.
Minimum Units	Until this many units accumulate, the system awards no credits.
Credits to Start	Number of games a player must purchase to begin play.
Credits to Continue	Number of games a player must purchase to resume play.
Max Credits	Limits the number of credits that the game will accept.
Coins per Bill	How many coins one bill is worth.

Main Menu (continued)
Adjustments Menu (continued)
Pricing Menu (continued)
Custom Pricing Menu

Custom Pricing

Select CUSTOM PRICING at the Pricing Menu. The Custom Pricing Menu permits you to program and use your own pricing table. You can save several pricing schemes and chose between them as desired.

Highlight an option with any player panel joystick. Change the option with any player panel button. Press any START button to save your pricing table and exit from the menu.



CUSTOM PRICING OPENING MENU

Add allows you to write a new custom pricing scheme. If you choose ADD, the system directs you to...

- [] 1. Name your scheme.
- [] 2. Program pricing information.
- [] 3. Select the coin denomination for your scheme.
- [] 4. Retain or alter the pricing screen message. (Later, check it in Game Mode by pressing START.)
- [] 5. Save your pricing scheme.
- [] 6. Use your pricing scheme by selecting it.

Delete permits you to eliminate a single custom pricing scheme.

Edit lets you modify a stored custom pricing scheme.

Delete, when enabled, clears all custom pricing schemes.

Select enables you to choose which custom pricing scheme is the active one.

Main Menu (continued)
Adjustments Menu (continued)
Pricing Menu (continued)
Custom Pricing Menu (continued)
Creating Pricing Scheme Menu

Creating Pricing Scheme

After you name your custom pricing scheme, you encounter the Creating Pricing Scheme Menu. This menu is where you program the pricing scheme. You can save several pricing schemes and choose between them as desired.

Highlight an option with any player panel joystick. Select Change Mode with any player panel button. Use a joystick to change the option. Save your setting by pressing any player panel button. Press any START button to exit from the menu. Exiting invokes the Select Currency Menu. Use this menu to choose the coin denomination that players will use. Exit by choosing DONE.

CREATING XXXX			
LEFT UNITS	XX	RIGHT UNITS	XX
CENTER UNITS	XX	EXTRA UNITS	XX
DBV UNITS	XX	UNITS PER CREDIT	XX
UNITS / BONUS	XX	MIN UNITS	XX
CREDITS TO START	XX	CREDITS TO CONT.	XX
MAX CREDITS	XX	COINS / BILL	XX
SHOW FRACTIONS	XX	LEFT COUNT	XX
RIGHT COUNT	XX	CENTER COUNT	XX
EXTRA COUNT	XX	DBV COUNT	XX
USE STICK TO SELECT AN ITEM TO MODIFY			
PRESS ANY BUTTON TO MODIFY THE ITEM			
PRESS ANY START BUTTON TO SAVE AND EXIT			

CUSTOM PRICING MENU

SELECT CURRENCY
DOLLAR
POUND
GUILDER
SCHILLING
FRANC
KRONE
MARKKA
DEUTSCHE MARK
LIRE
FORINT
PESETA
YET
DONE

SELECT CURRENCY MENU (PAGE 2 OF CREATING XXXX MENU)

The Custom Pricing Menu employs the same terms that appear on the Current Pricing Table. See the table below for definitions of these terms.

PRICING MENU TERMS

MENU TERM	DISCUSSION
Slot Units; Bill Validator (DBV) Units	Cyber-currency. This adjustment assigns a number of "units" to each coin mechanism or bill acceptor. For instance, if a quarter buys 1 unit, then \$1 buys 4 units. (<i>See Coins per Bill.</i>) You insert a coin into a 1-unit coin acceptor. The system, due to its programming, knows that your coin is worth one unit.
Units per Credit	How many units equal one credit. (Units buy credit, the price of one game.)
Units per Bonus	Units awarded when a player earns a bonus.
Minimum Units	Until this many units accumulate, the system awards no credits.
Credits to Start	Number of games a player must purchase to begin play.
Credits to Continue	Number of games a player must purchase to resume play.
Max Credits	Limits the number of credits that the game will accept.
Coins per Bill	How many coins one bill is worth.

BASIC CUSTOM PRICING. Custom pricing creates an imaginary currency exchange. In this currency exchange, the coins of the realm are "units." Think of units as a type of cyber-currency, useful only within the game software. By inserting coins, you purchase units.

Since units are only negotiable within game software, the system stores your units for you. When the system receives enough units, it buys a game for you. The price of a game is one "credit." You can think of credits as a second form of cyber-currency.

Even though you've now bought one game, you may not be able to begin playing. In many pricing schemes, you must buy two or more credits to begin play. The idea here is something like a minimum order of goods at a store. That is, the operator can "shrink-wrap" two or more games in a package. You can't play unless you buy the entire package.

• **1 / 25¢ COIN; 1 CREDIT TO START.** In a simple, quarter pricing scheme, the player inserts one coin to buy one unit. The system exchanges that unit for one credit. If CREDITS TO START contains the value one, then play commences. A dollar bill buys four units.

Left Slot Units	Validator Units	Units / Credit	Credits to Start	Coins / Bill
1	4	1	1	4

• **1 / 3 X 25¢; 2 CREDITS TO START.** Again, assuming quarter slots, here's one way to implement 75¢ pricing... In this scheme, each coin that the player inserts buys one unit. The system exchanges three units for one credit. CREDITS TO START contains the value two. To play, the player must pay for two credits. In this scheme, a dollar buys four units.

Left Slot Units	Validator Units	Units / Credit	Credits to Start	Coins / Bill
1	4	3	2	4

• **2 / 1 COIN; 6 CREDITS TO START.** Now let's consider a more unusual pricing scheme. Here, the player can buy two units with one coin. The system exchanges each of these units for one credit. Notice that CREDITS TO START contains the value six. To play, the player must insert two more coins to pay for six credits. Also notice that if the player pays with a bill, the system throws in an extra unit.

Left Slot Units	Validator Units	Units / Credit	Credits to Start	Coins / Bill
2	9	1	6	4

Main Menu (continued)
Adjustments Menu (continued)
Pricing Menu (continued)
Custom Pricing Menu (continued)
Current Pricing Prompt

Pricing Prompt

After you exit the Select Currency Menu, you encounter the Current Pricing Prompt Menu. The Current Pricing Prompt Menu allows you to enter a brief pricing or advertising message. The video game machine displays your message during the Attract Mode.

Select YES at the menu's first page. The Screen Message Entry Menu opens. You may enter up to three lines of text. Each line may include up to 32 alphanumeric characters. Here's an example message...

1 CREDIT / 2 COINS
EAT AT JOE'S

Highlight a letter with any player panel joystick. Select the letter with any player panel button. Delete the rightmost character of the default message by selecting the on-screen asterisk (*). Watch the bottom of the screen to see your message line develop. Save the entire line and proceed to the second line by selecting the arrow (>).



CURRENT PRICING PROMPT MENU

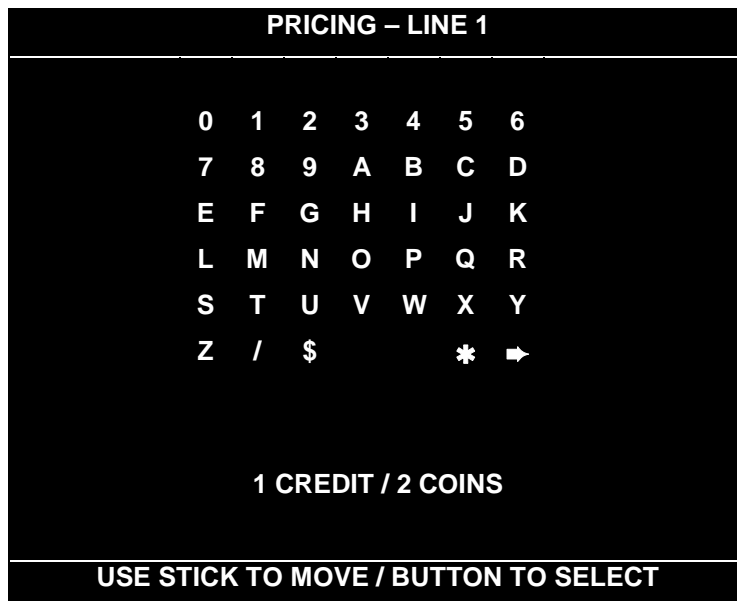

SCREEN MESSAGE ENTRY MENU (PRICING - LINE 1)

After you complete your message, you may edit it by reentering the Screen Message Entry Menu. To reenter the menu, choose EDIT from the Custom Pricing Menu.

Main Menu (continued)
Adjustments Menu (continued)
Pricing Menu (continued)
Custom Pricing Menu (continued)
Save Pricing Scheme

Save Pricing Scheme

Exiting from the Screen Message Entry Menu invokes the Save Pricing Scheme Menu. The Save Pricing Scheme Menu allows you to save your pricing scheme.

Highlight an option with any player panel joystick. Select YES to save, or NO to delete your pricing scheme.

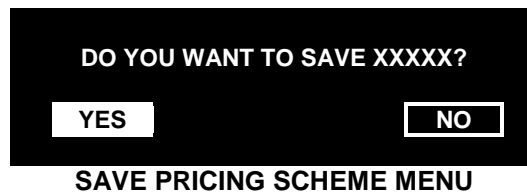

To use the new pricing scheme, you must now select it. The program returns you to the Custom Pricing Menu. You'll notice a few more entries on the menu. Besides ADD and EXIT, you'll see that you can now EDIT or SELECT a pricing scheme.

Highlight SELECT with any player panel joystick. To use your pricing scheme, press any player panel button. The program acknowledges your pricing scheme choice and returns you to Custom Pricing Menu. Choose EXIT to return to the Pricing Menu.



Main Menu (continued)
Adjustments Menu (continued)
Free Play Menu

Free Play

Select FREE PLAY at the Adjustments Menu. Free Play is a useful feature for promotions and long-term testing under play conditions. Enable Free Play to allow players to play the game without inserting currency. Disable Free Play to sell games.

Highlight an option with any player panel joystick. Select the option with any player panel button.

Main Menu (continued)
Adjustments Menu (continued)
Attract Sound Menu

Attract Sound

Select ATTRACT SOUND at the Adjustments Menu. The Attract Mode operates between games. It attempts to lure prospective players into trying your game. Attract Mode sound may not be appropriate for some locations. The Attract Sound Menu allows you to enable or disable the Attract Mode sound feature. You can turn Attract Mode sound on or off without changing the game volume level.

Highlight an option with any player panel joystick. Select the option with any player panel button.

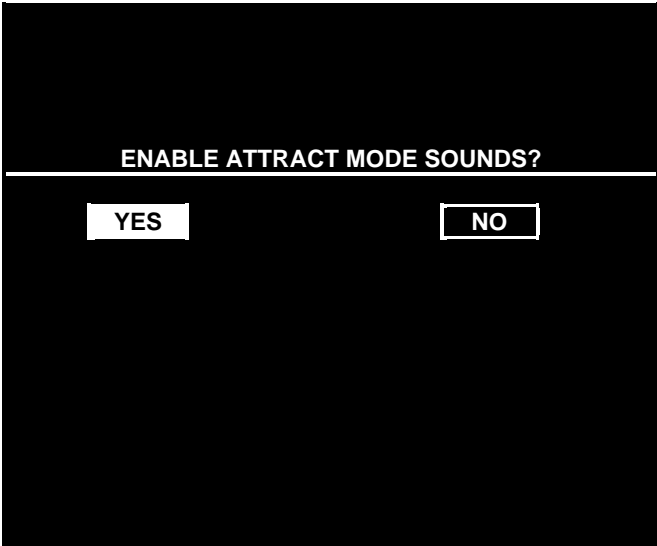

ATTRACT SOUND MENU

	<p>NOTICE: After you enable Attract Mode sound, you can adjust the Attract Mode volume level. See the Main Menu.</p>
---	---

Main Menu (continued)
Adjustments Menu (continued)
Additional Adjustments Menu

ADDITIONAL ADJUSTMENTS

Select ADDITIONAL ADJUSTMENTS at the Adjustments Menu. Additional Adjustments menu items allow you to set the game to match player requirements. These adjustments affect speed, challenge, rewards, etc. that determine player enjoyment.

Highlight an option with any player panel joystick. Select the option with any player panel button.



Game Difficulty allows you to alter the challenge that a game poses to players. Choose the level that most closely matches the players’ skills.

Discount Price / Credits adjusts the quantity of buy-in points to encourage multiple game purchases.

Clock Speed alters how much game time that a player can purchase for one credit. Choose one of these settings: Extra slow, slow, medium, fast or extra fast.

Free Game, when enabled, allows the program to award a free game. The free game may be a four-player or a one-on-one game. The free game may also involve competition against the game computer.

Free Quarter. The program divides games into quarters, as in NBA rules. The Free Quarter feature, when enabled, allows the program to award a free game quarter. The free quarter may be a four-player or a one-on-one quarter. The free quarter may also involve competition against the game computer.

Clear Player Records allows you to zero out game play data. Examine and record this information before you clear it. Once you’ve cleared player records, you can’t retrieve the previous data.

Clear World Records allows you to zero out world record data. Examine and record this information before you clear it. Once you’ve cleared player records, you can’t retrieve the previous data.

Player Head Size allows you to alter the head size of on-screen characters. This feature determines whether the characters appear more lifelike, or more like caricatures. Choose “normal” or “big.”

Tournament Mode, when enabled, adapts your game’s scoring for tournament-style play.

Computer Assistance, when enabled, permits the game computer to aid players in play action.

Attract Movie Sound, when enabled, allows Attract Mode movie sound with Attract Mode sound off. The Attract Mode movie is only one component of the Attract Mode graphics.

Main Menu (continued)
Adjustments Menu (continued)
Full Factory Restore Menu

FULL FACTORY RESTORE

Select FULL FACTORY RESTORE at the Adjustments Menu. The Full Factory Restore menu allows you to clear all memory counters at once.

Highlight an option with any player panel joystick. Select the option with any player panel button.



FULL FACTORY RESTORE MENU

	<p>NOTICE: Examine and record audit information before you make changes. Once you've cleared the counters, you can't retrieve previous data from the system.</p>
---	---

Examine and record utility values before you make changes. If you choose YES, the system restores all adjustments and audits to factory default values. This change isn't reversible. The system can't restore the previous values. With the settings restored, the system displays the Reset Complete Menu.

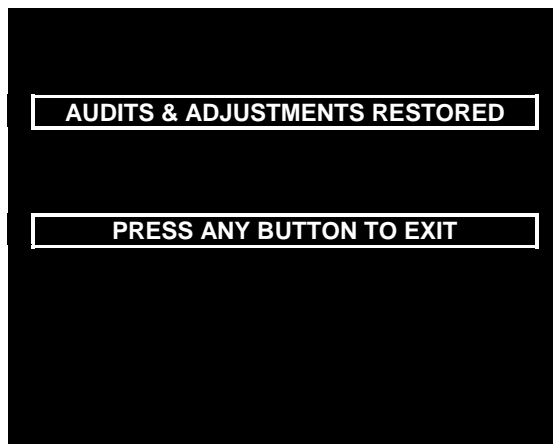

RESET COMPLETED MENU

Main Menu (continued)

Set Volume Level Menu

SET VOLUME LEVEL

Select VOLUME LEVEL at the Main Menu. The Set Volume Level Menu appears, and music plays continuously.

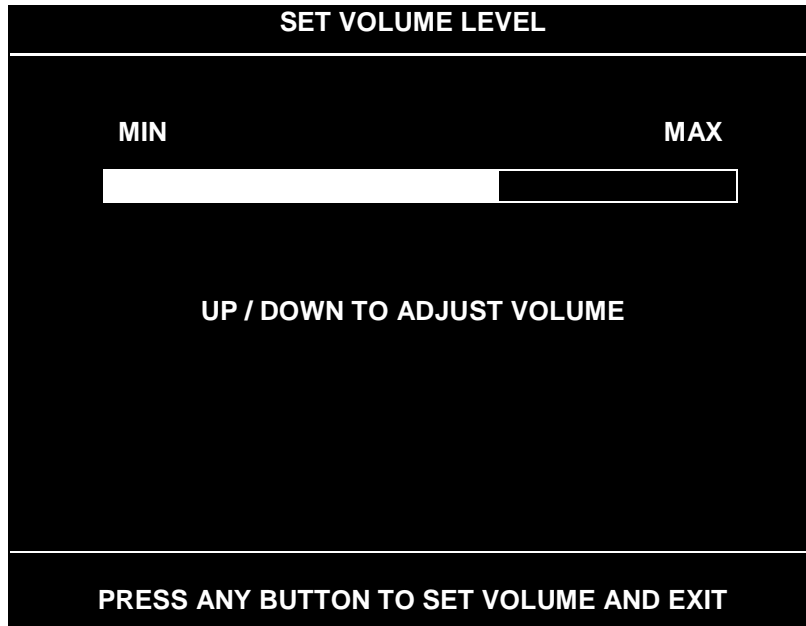

Raise or lower the game's sound level with any player panel joystick. (You can also use the volume up/down buttons on the diagnostic switch bracket.) Save your change and return to the Main Menu by pressing any player panel button.



SET VOLUME LEVEL MENU

Loud games attract more player interest than games with low-level sound.

You can turn Attract Mode sound on or off without changing the game volume level. (See *Adjustments*.)

	<p>NOTICE: Sound level adjustments affect the volume of tests as well as of game play. If you set volume levels to minimum (zero), the speakers are silent during audio tests. We recommend setting volume levels to a moderately high value whenever you perform sound tests. After you complete tests, you may return sound levels to previous settings.</p>
	<p>NOTICE: You can also change the volume level during Game Mode. Press VOLUME UP or VOLUME DOWN as necessary until you achieve the desired volume. These buttons are inside the coin door.</p>

Main Menu (continued)

Set Attract Volume Level Menu

SET ATTRACT VOLUME LEVEL

Select ATTRACT VOLUME LEVEL at the Main Menu. You must enable Attract Mode sound before setting the Attract Mode volume level. (You can enable Attract Sound from the Adjustments Menu.)

When you display the Set Attract Volume Level Menu, music plays continuously. Raise or lower the game's Attract Mode sound level with any player panel joystick. (You can also use the volume up/down buttons on the diagnostic switch bracket.) Save your change and return to the Main Menu by pressing any player panel button. Your setting won't affect the game play sound level.

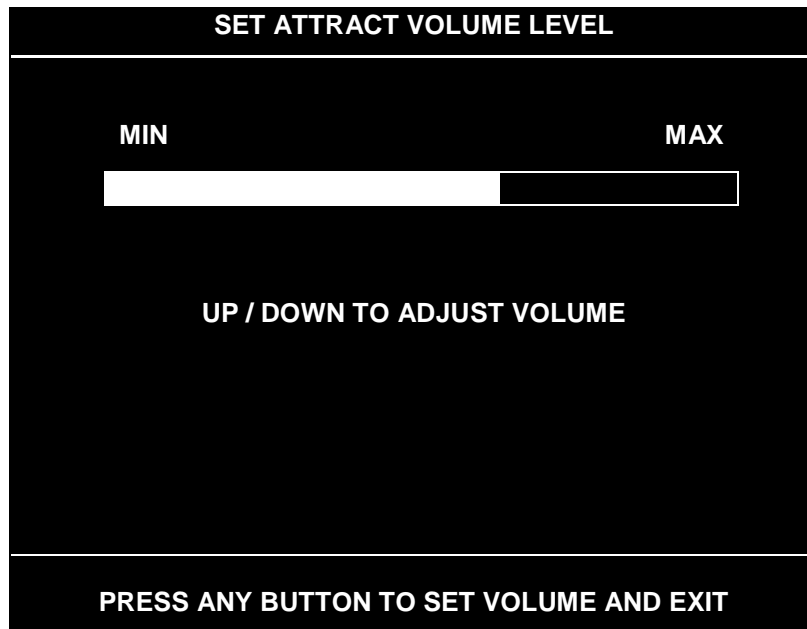

SET ATTRACT VOLUME LEVEL MENU

A loud Attract Mode encourages player interest. You can turn Attract Mode sound on or off without changing the game volume level. (See *Adjustments*.)

Main Menu (continued)

Utilities Menu

UTILITIES

Select UTILITIES at the Main Menu. Utilities Menu items allow you to clear bookkeeping totals. From the Utilities Menu, you can also restore game adjustments to factory settings.

Highlight an option with any player panel joystick. Select the option with any player panel button.



UTILITIES MENU

Dump Audits allows you to send data to the game computer's serial port. You can connect a serial printer to make a paper record of your audit data.

Clear Credits opens a menu that allows you to zero the game's credit data. Examine and record audit information before you make changes.

Clear Audits opens a menu that allows you to zero the game's audit data.

Reset High Scores permits you to delete player names and scores that appear in the Attract Mode. This feature may be useful if players insert inappropriate language into the high score table.

Default Adjustments opens a menu that allows you to reset game adjustments to factory settings.

Full Factory Restore allows you to reset game adjustments and audits to factory settings.





NOTICE: Be careful when clearing audit information. Once you clear data, you can't restore it.

NBA SHOWTIME GOLD EDITION / NFL BLITZ 2000 GOLD EDITION CONVERSION KIT

CHAPTER FIVE

WIRING

	<p>WARNING: Failure to reconnect ground wires or replace metal shields may result in radio frequency interference.</p>
	<p>NOTICE: The term VGM refers to the video game machine.</p>

JAMMA Chart

Function	Wire Color	Pin	Function	Wire Color	Pin
Ground	Black	A	Ground	Black	1
Ground	Black	B	Ground	Black	2
+5VDC	Red	C	+5VDC	Red	3
+5VDC	Red	D	+5VDC	Red	4
-5VDC	Yellow	E	-5VDC	Yellow	5
+12VDC	Orange	F	+12VDC	Orange	6
Key	N/C	H	Key	N/C	7
Coin Counter 2	Brown-Red	J	Coin Counter 1	Brown	8
Not Used	N/C	K	Not Used	N/C	9
Speaker -, Left	Brown-Gray	L	Speaker +, Left	Red-Gray	10
Speaker -, Right	Brown-White	M	Speaker +, Right	Red-White	11
Video Green	Yellow-Green	N	Video Red	Yellow-Red	12
Video Sync	Yellow-White	P	Video Blue	Yellow-Blue	13
Service Credits	White-Gray	R	Video Ground	Yellow-Black	14
Slam Tilt	Black-Green	S	Test	Black-Blue	15
Coin 2	Black-Red	T	Coin 1	Black-Brown	16
2 Start	Violet-White	U	1 Start	White	17
2 Up	Violet-Black	V	1 Up	White-Black	18
2 Down	Violet-Brown	W	1 Down	White-Brown	19
2 Left	Violet-Red	X	1 Left	White-Red	20
2 Right	Violet-Orange	Y	1 Right	White-Orange	21
2 Button A	Violet-Yellow	Z	1 Button A	White-Yellow	22
2 Button B	Violet-Green	a	1 Button B	White-Green	23
2 Turbo	Violet-Blue	b	1 Turbo	White-Blue	24
Not Used	Violet	c	Not Used	White-Violet	25
Not Used	N/C	d	Not Used	N/C	26
Ground	Black	e	-5V Ground	Yellow-Brown	27
Ground	Black	f	Ground	Black	28
Solder Side of Circuit Board			Component Side of Circuit Board		

Control Panel Wires That Aren't Part of Main JAMMA Harness

Function	Wire*	SIO Bd, P7-	Function	Wire*	SIO Bd, P14-
4 Digital Ground	Blk	1	3 Digital Ground	Blk	1
+5 Volts	Red	2	+5 Volts	Red	2
Unused	NC	3/4/5/15	Unused	NC	3/4/5/15
4 Start	Gry-Wht	6	3 Start	Blu-Wht	6
4 Stick Up, Bit 0	Gry-Blk	7	3 Stick Up, Bit 0	Blu-Blk	7
4 Stick Down, Bit 1	Gry-Brn	8	3 Stick Down, Bit 1	Blu-Brn	8
4 Stick Left, Bit 2	Gry-Red	9	3 Stick Left, Bit 2	Blu-Red	9
4 Stick Right, Bit 3	Gry-Orn	10	3 Stick Right, Bit 3	Blu-Orn	10
4 Button A	Gry-Yel	11	3 Button A	Blu-Yel	11
4 Button B	Gry-Grn	12	3 Button B	Blu-Grn	12
4 Button C, Turbo	Gry-Blu	13	3 Button C, Turbo	Blu	13
4 Button D (N/U)	Gry-Vio	14	3 Button D (N/U)	Blu-Vio	14

*Abbreviations: Bd = Board; NC = Not Connected; Blk = Black; Brn = Brown; Orn = Orange; Yel = Yellow; Grn = Green; Blu = Blue; Vio = Violet; Gry = Gray; Wht = White.

Wires That Aren't Part of Main JAMMA Harness

Function	Wire*	Aux Adptr, P1-	Function	Wire*	SIO Bd, P23-
Digital Ground	Blk	1	Digital Ground	Blk	1
Output Bit 0	Orn-Gry	2	Coin 3	Blk-Orn	2
Output Bit 1	Yel- Gry	3	+5 Volts	Red	3
Output Bit 2	Blu- Gry	4	+12 Volts	Orn	4
Output Bit 3	Vio- Gry	5	Unused	Key	5
Unused	NC	6	Coin 4	Blk-Yel	6
Unused	NC	7	Dollar Bill	Blk-Wht	7
Unused	NC	8	Volume Down	Orn-Red	8
Unused	NC	9	Volume Up	Orn-Grn	9
Unused	NC	10	Unused	NC	10
Unused	NC	11	Unused	NC	11
Unused	NC	12	Function	Wire Color*	SIO Bd, P3-
Unused	NC	13	+12 Volts	Orn	1
Unused	NC	14	Digital Ground	Blk	2
Digital Ground	Blk	15	Digital Ground	Blk	3
--	--	--	+5 Volts	Red	4

*Abbreviations: Bd = Board; NC = Not Connected; Blk = Black; Brn = Brown; Orn = Orange; Yel = Yellow; Grn = Green; Blu = Blue; Vio = Violet; Gry = Gray; Wht = White.

D.C. Power Source Voltage Limits

Function	Range Limits	ID	Function	Range Limits	ID
Digital Circuits	+4.90V to +5.10V	+5V	Audio, Lights	-4.75V to -5.25V	-5V
Audio, DBV	+11.5V to +12.5V	+12V	NOTE: +5V is adjustable at the Power Supply		

CABINET WIRING DIAGRAM

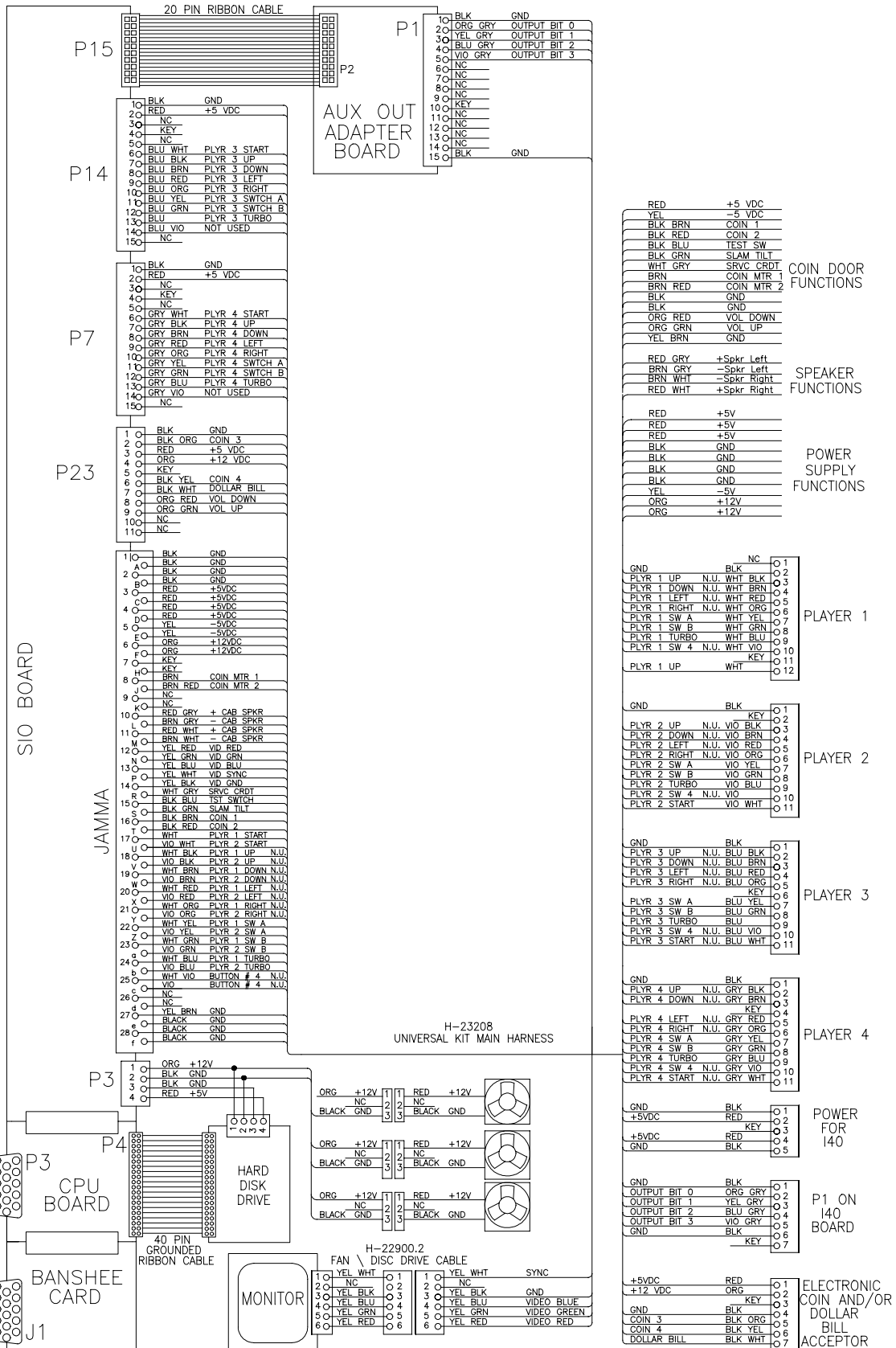

CONTROL PANEL WIRING DIAGRAM

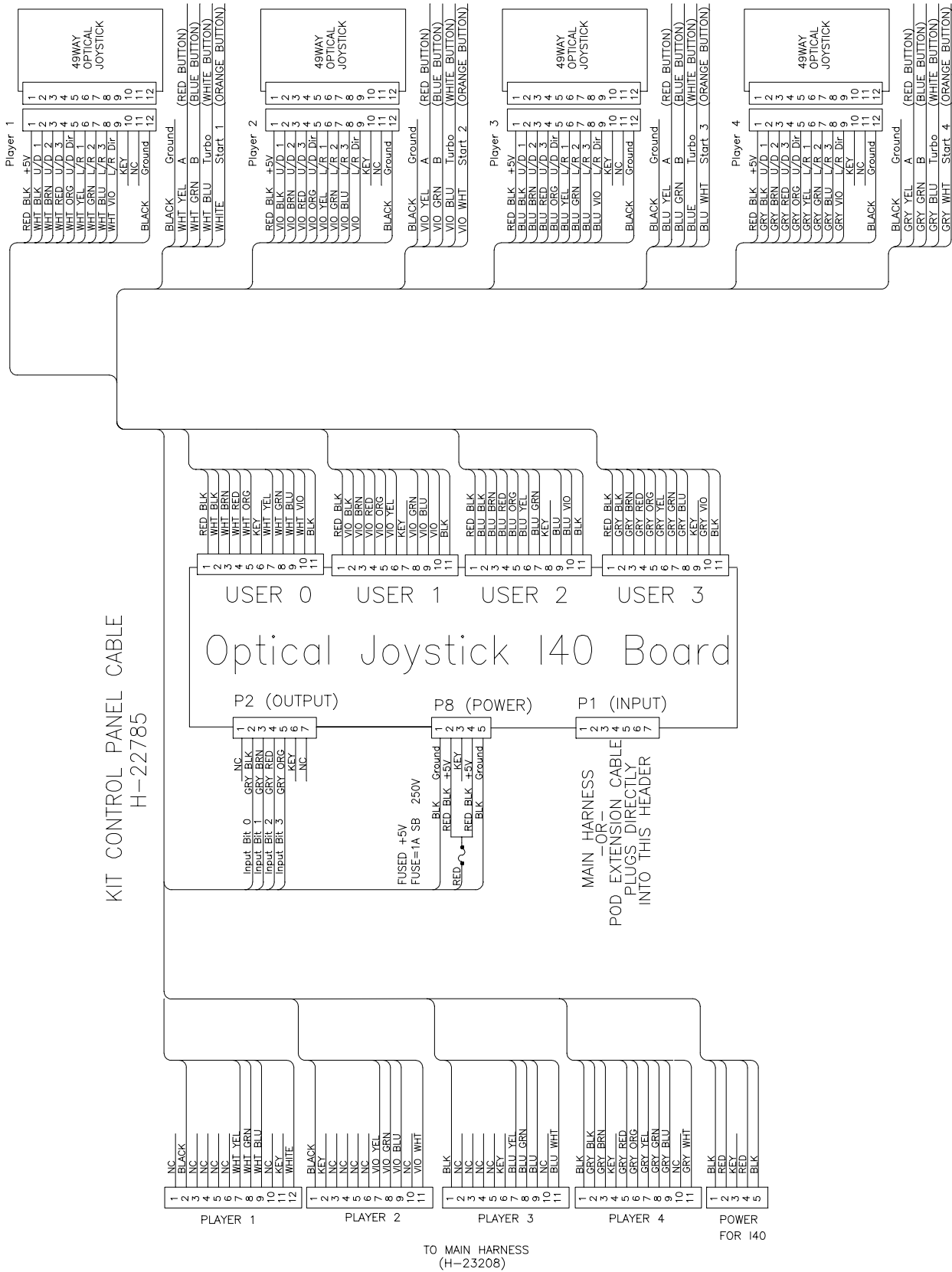
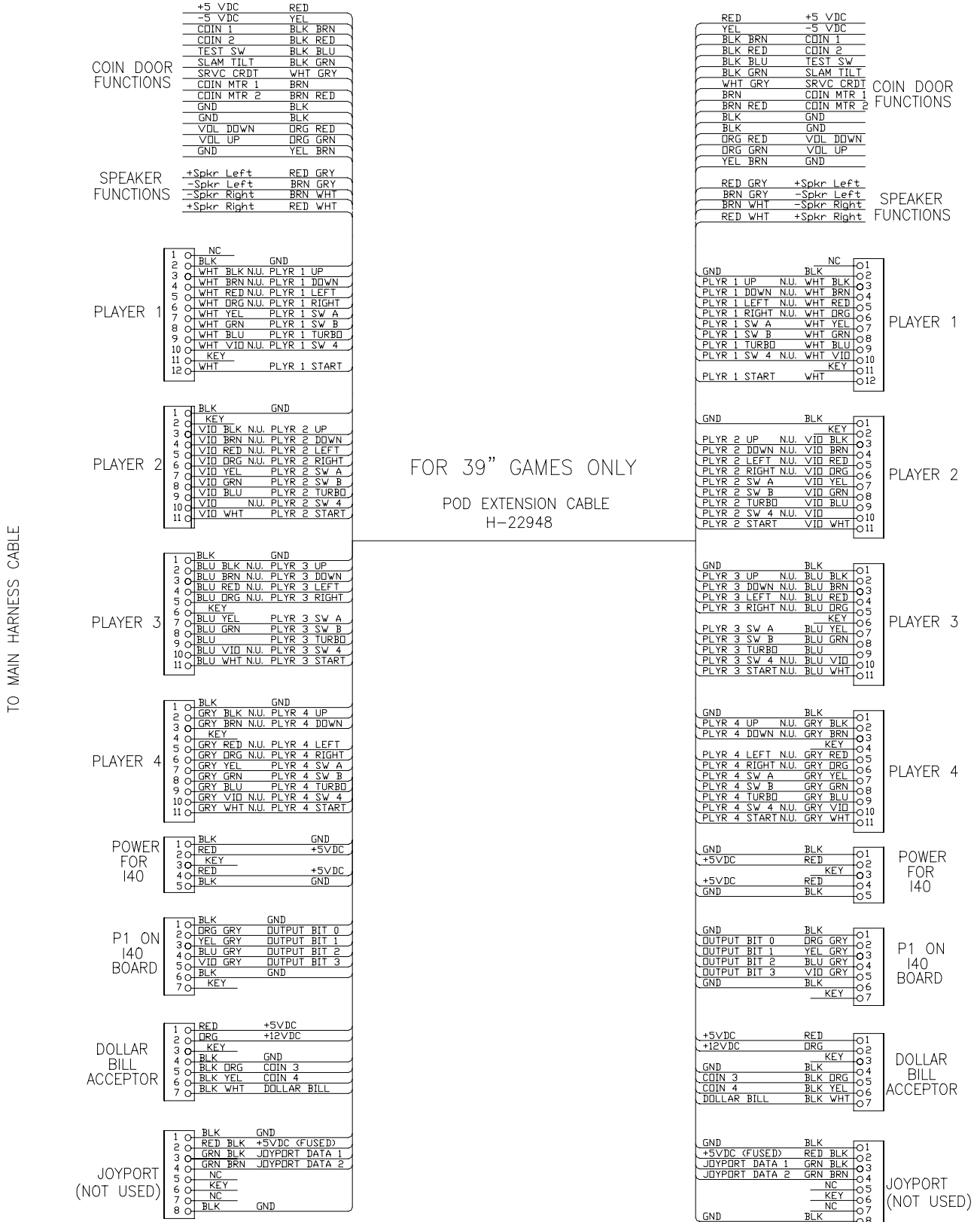
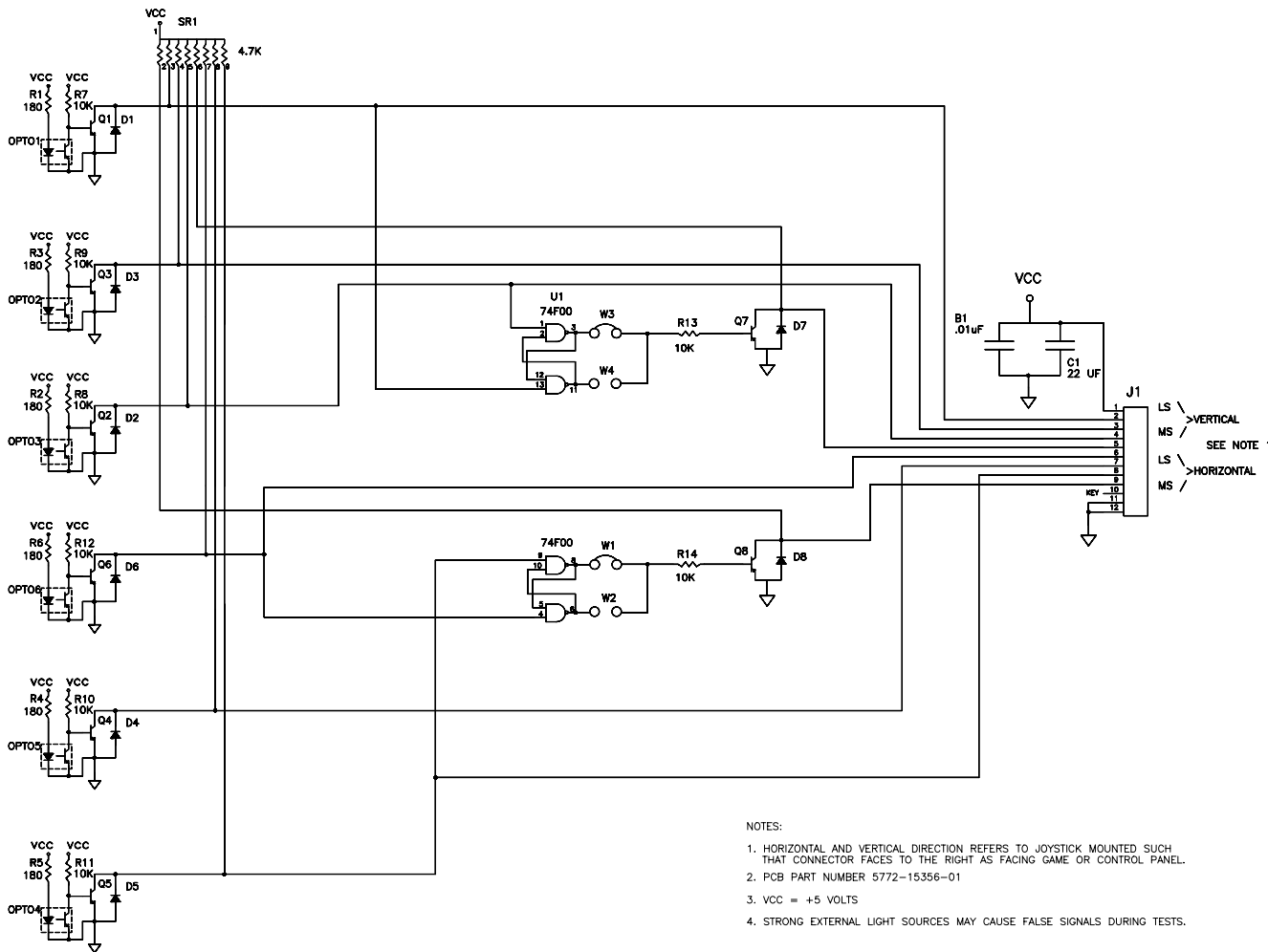

DIAGRAM OF EXTENSION CABLE FOR 39" VGM



CONTROL WIRING DIAGRAM (49-WAY JOYSTICK)



POSITION LOGIC TABLE

DIRECTION	FULLY LEFT	MODERATELY LEFT	SLIGHTLY LEFT	DEAD CENTER	SLIGHTLY RIGHT	MODERATELY RIGHT	FULLY RIGHT
FULLY UP	01110111 (00)	01110011 (01)	01110001 (02)	01110000 (03)	01111100 (04)	01111110 (05)	01111111 (06)
MODERATELY UP	00110111 (07)	00110011 (08)	00110001 (09)	00110000 (10)	00111100 (11)	00111110 (12)	00111111 (13)
SLIGHTLY UP	00010111 (14)	00010011 (15)	00010001 (24)	00010000 (24)	00011100 (24)	00011110 (19)	00011111 (20)
DEAD CENTER	00000111 (21)	00000011 (22)	00000001 (24)	00000000 (24)	00001100 (24)	00001110 (26)	00001111 (27)
SLIGHTLY DOWN	11000111 (28)	11000011 (29)	11000001 (24)	11000000 (24)	11001100 (24)	11001110 (33)	11001111 (34)
MODERATELY DOWN	11100111 (35)	11100011 (36)	11100001 (37)	11100000 (38)	11101100 (39)	11101110 (40)	11101111 (41)
FULLY DOWN	11110111 (42)	11110011 (43)	11110001 (44)	11110000 (45)	11111100 (46)	11111110 (47)	11111111 (48)

NOTE: 1. Connector pin sequence for the above data is as follows: 9 8 7 6 5 4 3 2 referred to ground at pin 12.
 2. Numbers in parentheses are found in the Switch Test. Program does not use the "slightly" positions.

CPU BOARD INDICATOR AND SWITCH LOCATIONS

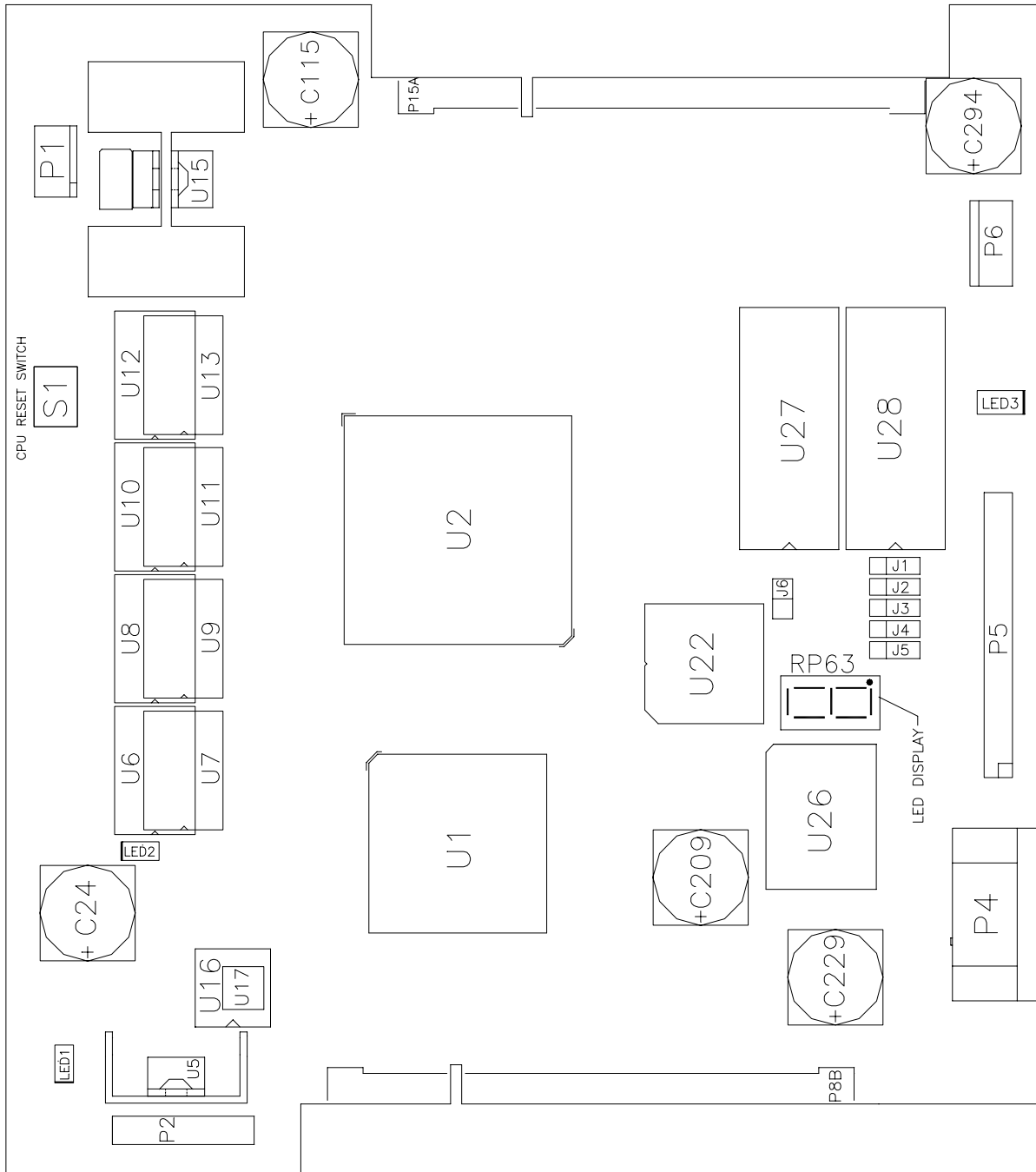

CPU BOARD SWITCH

Switch	Location	Function	Positions	State	Meaning
S1*	Edge Near U10 and U12	Resets and Restarts Game	2	Off	Normal Operation
				On	Forced Reset

***Notes**

This switch resets the CPU Board without shutting off power at the power supply.

CPU BOARD JUMPER LOCATION TABLE

Jumper	J1	J2	J3	J4	J5	J6
Located Near...	U28 & Connector P5					U22 & U27

CPU BOARD JUMPER POSITION TABLE

ROM Type	Default	Options*	J1	J2	J3	J4	J5	J6
Boot (U27)		27C080, 1M X 8, EPROM	1-2	2-3	1-2	1-2	--	--
	■	27C040, 512K x 8, EPROM	1-2	1-2	1-2	1-2	--	--
		27C010, 128K x 8, EPROM	1-2	1-2	1-2	2-3	--	--
		29F040, 512K x 8, Flash	2-3	1-2	2-3	1-2	--	--
		29F020, 256K x 8, Flash	1-2	1-2	2-3	1-2	--	--
		29F010, 128K x 8, Flash	1-2	1-2	2-3	1-2	--	--
Expansion (U28)		27C080, 1M x 8, EPROM	--	--	--	--	2-3	--
	■	27C040, 512K x 8, EPROM	--	--	--	--	1-2	--
		27C010, 128K x 8, EPROM	--	--	--	--	1-2	--
External Boot	■	Boot from CPU ROM	--	--	--	--	--	1-2
		Boot from SIO ROM	--	--	--	--	--	Re- moved

***Notes**

1. -- = Not Applicable

2. Memory type numbers shown are for blank parts. Your game requires programmed parts.

CPU BOARD LED INDICATOR STATUS TABLE

Device	Location	Function	Color	State	Meaning
LED1	Near U6, U7 & U16	3.3V CPU Power Indicator	Red	Off	Insufficient Power
				On	Power OK
				Blinking	Power Supply Fault
LED2	Near U28 & Connector P5	Hard Disk Drive Activity	Green	Off	Disk Not in Use
				On	Locked Up Disk
				Blinking	Normal Disk Activity
RP63	Near U22 & U26	Indicator	Red	Off*	See Note 3, Below.
				On*	
				Blinking* Sequentially	

Notes

- LED1 monitors CPU power (+3.3 volts). If this LED is off or blinking, investigate processor circuits. If other LEDs are off or blinking at the same time, check +5-volt circuits or the game power supply.
- LED2 flashes when the hard disk is operating during game play. LED2 may light continuously during startup. If this LED remains lighted, the hard drive may be locked up or faulty.
- Software controls RP63. In this game, RP63 initially indicates program startup stages. This LED is a seven-segment, alphanumeric display device. Normally, RP63 displays a lowercase "b," or an "O" pattern with sequentially blinking segments. During Self-Test screens, RP63 displays a "bouncing bar" that resembles a hyphen ("-").

SOUND I/O BOARD ASSEMBLY A-23704

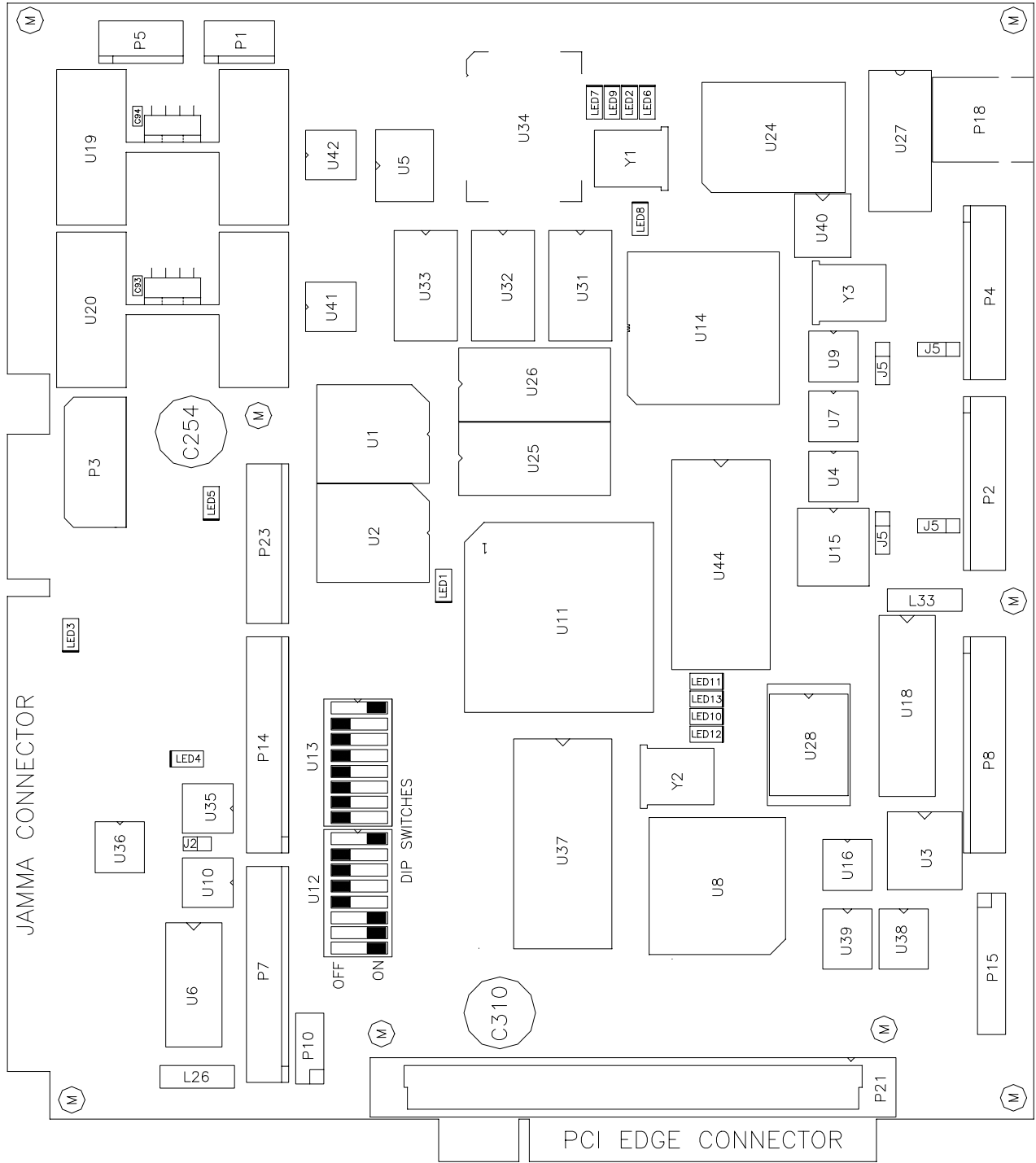

SOUND I/O BOARD JUMPER POSITION TABLE *

Jumper	Location	Function	Meaning	Position	State
J1 (Note 1)	Near U9 & Crystal Y3	I/O Connector P2	Input Mode	Pins 1 & 2	■
			Output Mode	Pins 2 & 3	
J2	Between U35 & U10	Video Sync	Positive Sync	Jumper Not Installed	■
			Negative Sync	Pins 1 & 2	
J3 (Note 2)	Near U15	I/O Connector P4	Input Mode	Pins 1 & 2	■
			Output Mode	Pins 2 & 3	
J4	None	None	Not Used	None	---
J5 (Note 2)	Between U15 & Connector P2	I/O Connector P4	Input Mode	Pins 1 & 2	■
			Output Mode	Pins 2 & 3	
J6	None	None	Not Used	None	---
J7	None	None	Not Used	None	---
J8 (Note 1)	Between U9 & Connector P4	I/O Connector P2	Input Mode	Pins 1 & 2	■
			Output Mode	Pins 2 & 3	

Notes

1. Configure I/O port P2 by setting both jumpers J1 and J8 to input or output mode.
2. Configure I/O port P4 by setting both jumpers J3 and J5 to input or output mode.

SOUND I/O BOARD LED INDICATOR STATUS TABLE

LED	Location	Function	Color	State	Meaning
LED1 (Note 1)	Near U11	Not Used (Remains Off)	Green	Off	--
				On	--
				Blinking	--
LED2 (Note 2)	Near U34 & Crystal Y1	Linking Connector Status	Green	Off	Not in Use (No Game Linking)
				On	Link Continuity Good
LED3 (Note 2)	Near the JAMMA Connector	-5V Power Indicator	Red	Off*	No Power
				On*	Normal Operation
LED4 (Note 2)	Near U35 & Connector P14	+12V Power Indicator	Red	Off	No Power
				On	Normal Operation
LED5 (Note 2)	Near Connector P23	+5V Power Indicator	Red	Off	No Power
				On	Normal Operation
LED6 (Note 2)	Near U34 & Crystal Y1	CPU Linking Activity	Red	Off	Not in Use
				On	CPU Communicating with Ethernet Controller
LED7 (Note 2)	Near U34 & Crystal Y1	Linking Transmitting Data	Red	Off	Not in Use (No Game Linking)
				On	Sending Data
				Blinking	Normal Operation
LED8 (Note 1)	Near U14 & Crystal Y1	Audio Activity	Yellow	Off	No Sound Boot ROM
				On	Locked Up
				Blinking	Normal Operation
LED9 (Note 2)	Near U34 & Crystal Y1	Linking Receiving Data	Yellow	Off	Not in Use (No Game Linking)
				On	Receiving Data
LED10 (Note 1)	Near U44 & Crystal Y2	Not Used (Remains On)	Green	Off	--
				On	--
				Blinking	--
LED11 (Note 1)	Near U44 & Crystal Y2	Not Used (Remains On)	Red	Off	--
				On	--
				Blinking	--
LED12 (Note 1)	Near U44 & Crystal Y2	Not Used (Remains On)	Yellow	Off	--
				On	--
				Blinking	--
LED13 (Note 1)	Near U44 & Crystal Y2	Not Used (Remains On)	Yellow	Off	--
				On	--
				Blinking	--

Notes

- Software controls this LED. Indications are game and revision-specific. Changing the EPROMs on this board may alter the function of this LED. Firmware damage may also cause new or different LED behavior.
- Hardware controls this LED. Indications depend on hard-wired circuitry. A change in normal LED behavior may indicate a circuit fault. Changing the EPROMs on this board shouldn't alter the function of this LED.

VIDEO BOARD INDICATOR AND SWITCH LOCATIONS

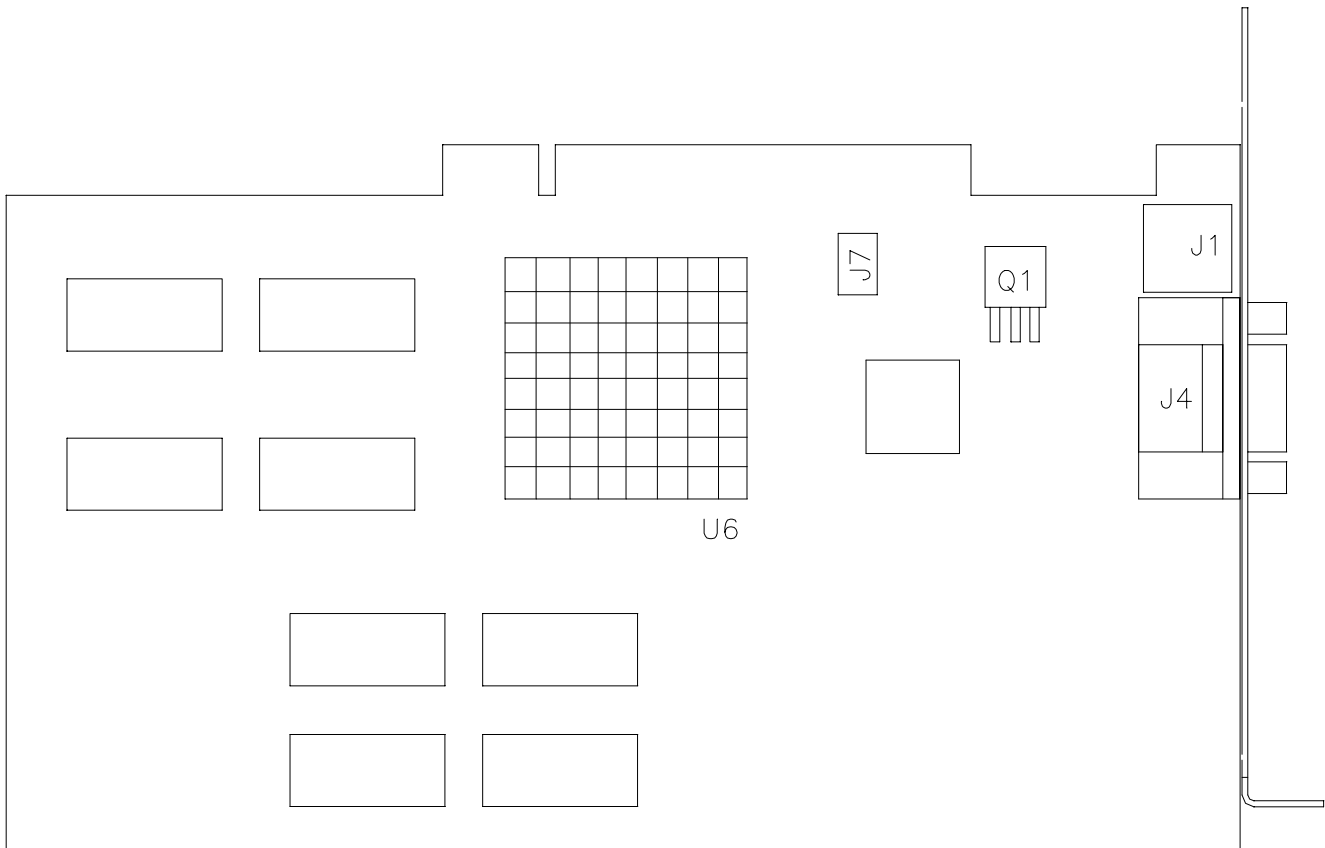



Note

This video board has no jumpers or LEDs.

NBA SHOWTIME GOLD EDITION / NFL BLITZ 2000 GOLD EDITION CONVERSION KIT

CHAPTER SIX

TROUBLESHOOTING

	NOTICE: The term VGM refers to the video game machine.
	CAUTION: This VGM uses complex electronic components that are <i>very sensitive to static electricity</i> . Observe the following precautions before handling VGM electronics. Failure to do so may void your warranty and could damage electronic assemblies.

- Before servicing electronics, turn off AC power to the VGM. Wait for capacitors to discharge.
- Before touching or handling electronic assemblies, discharge static electricity on your body. To discharge this static, begin by connecting the line cord to a grounded outlet. Don't turn on the VGM! Next, touch the safety ground stud of the power supply chassis.
- Store electronic assemblies in an anti-static area. Use anti-static bags to store or transport VGM circuit boards. Transport the hard drive in its shipping container.
- Don't remove or connect electronic assemblies when cabinet power is on. Otherwise, you'll damage electronic assemblies and void the VGM warranty.
- After you complete maintenance or service, replace ground wires, shields, safety covers, etc. Install and tighten ground and mounting screws.

Coin Mechanism and Pricing Troubleshooting Table

SYMPTOM	CAUSE	REQUIRED ACTION
<ul style="list-style-type: none"> VGM (<i>video game machine</i>) accepts currency or tokens, but number of credits per coin or bill is incorrect. 	Improper settings at Pricing Menu	From Coin Options Menu, choose PRICING OPTIONS MENU. Verify that units and credits are set correctly.
	Incorrect pulse width on bill validators	<ol style="list-style-type: none"> Consult bill validator manufacturer's literature. Adjust pulse width on validator to long setting. Retest validator operation.
	Faulty wiring	<ol style="list-style-type: none"> Check that cabinet wiring is correct for this VGM. Assure that coin meter and coin switches connect properly to control input wires.
	Faulty coin mechanism	<ol style="list-style-type: none"> Verify that coin mechanism works correctly by testing it in working VGM. If mechanism is bad, replace it.
<ul style="list-style-type: none"> VGM won't accept currency or tokens. VGM won't start. Audio and video are present. 	Improper currency	<ol style="list-style-type: none"> Unlock and open cash door. Empty cash box. Inspect revenue for counterfeit currency. Check vault. Remove any items that block path from mechanism.
	Faulty coin mechanism	<ol style="list-style-type: none"> Unlock and open coin door. Check each mechanism for proper mounting. Remove mechanism. Clear currency path. Reinstall mechanism and latch it. Enter Menu System by pressing and holding TEST MODE switch inside coin door. From Main Menu, choose CONTROLS TEST. Use tests to confirm operation of coin switches.
	Tilted coin mechanism or VGM	<ol style="list-style-type: none"> Verify that mechanism is level after doors close. Repair or replace coin door if it is bent or damaged. If necessary, adjust cabinet leg levelers to keep mechanisms vertical.
<ul style="list-style-type: none"> Coin indicators don't light 	Burned-out bulb	<ol style="list-style-type: none"> Burned-out bulbs may appear white or darkened. Check continuity with DVM. Replace burned-out bulb with same type.
	Open fuse circuit	<ol style="list-style-type: none"> Check fuse continuity with DVM. If fuse is blown, replace fuse with same type. If fuse isn't blown, check wiring.



CAUTION: Don't remove or install any connector when power is turned on. Installation under power will damage the circuit boards or hard disk drive and void the warranty.

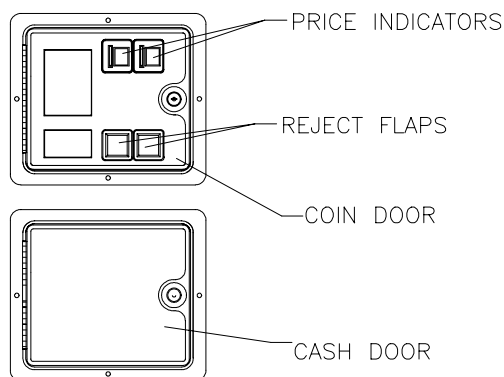

Typical Coin Mechanism Mounting

VGM Startup Troubleshooting Table

SYMPTOM	CAUSE	REQUIRED ACTION
<ul style="list-style-type: none"> VGM (video game machine) doesn't start. VGM appears completely non-functional. No audio No illumination No video display 	Power problem	<ol style="list-style-type: none"> 1. Check that VGM power switch is on. 2. Inspect electronics to see if fans are turning. <i>If not:</i> Is power supply connected to its power cable? Is power supply turned on? 3. Plug VGM into AC power outlet. Verify presence of AC line voltage.
	Improper line voltage switch setting	Turn off VGM power. Unplug AC line cord. Check line voltage switch. If necessary, set it to agree with local AC line voltage. Retest VGM.
	Open fuse	<ol style="list-style-type: none"> 1. Turn off VGM power. Examine AC fuse on power supply. 2. Examine DC fuses inside coin door vault. 3. Replace faulty fuses with identically rated parts. 4. Turn on VGM power. If fuse opens again, check DC wiring harness and connectors.
	Faulty wiring	<ol style="list-style-type: none"> 1. Remove line cord. Test line cord, power plug, and IEC connector for breaks or damage. Verify continuity of each wire in cord. Install cord at power chassis. Press connector firmly to seat it. 2. Check other cables in same manner. 3. Assure that cabinet wiring harness connectors fully seat in corresponding power supply and board connectors. 4. Inspect wiring for breaks or damage.
	Faulty circuit boards	<ol style="list-style-type: none"> 1. Turn off power for one minute and turn VGM on again. Power On Self-Test checks electronics. 2. Replace faulty parts and rerun self-test.

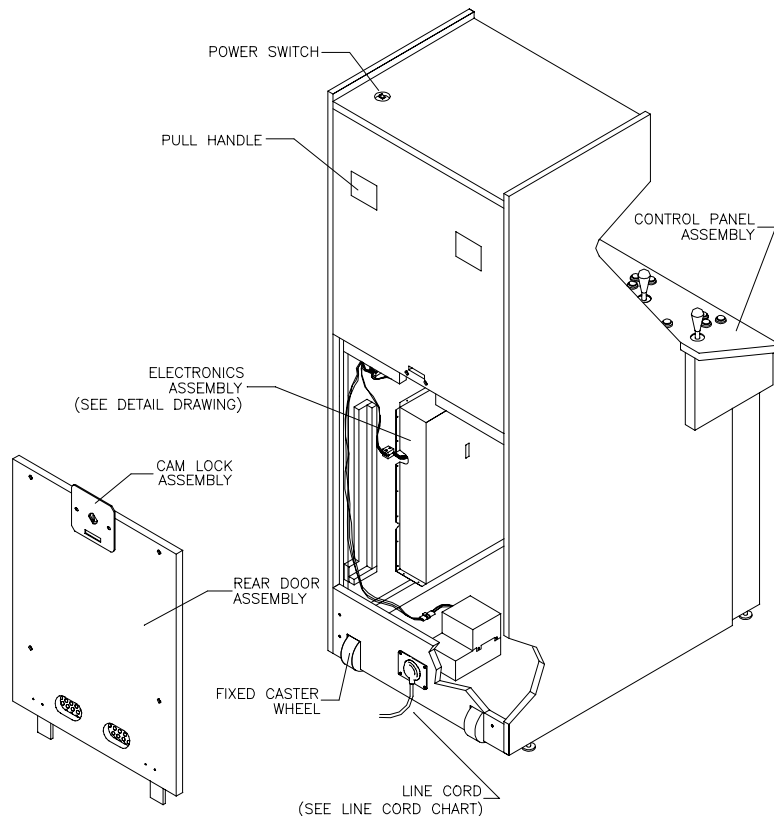

Typical Location of Power Supply and Line Cord

VGM Startup Troubleshooting Table, *continued*

SYMPTOM	CAUSE	REQUIRED ACTION
<ul style="list-style-type: none"> VGM (<i>video game machine</i>) appears non-functional. Currency acceptor price indicator is illuminated. 	Power problem	<ol style="list-style-type: none"> Inspect circuit boards under low-light conditions. LEDs glow if processor circuits receive voltage. Fan should be turning. These indications prove presence of DC from power supply. Still, voltages or signals may not be normal. Turn on VGM power. Using 20-volt DC setting on digital voltmeter, measure DC voltages at power connector pins. Using 2-volt AC setting on digital voltmeter, measure same DC voltages as above. Any reading indicates ripple or noise. In that case, service power supply.
	Faulty wiring	Turn off VGM power. Assure that wiring harness connectors attach and fully seat onto mating board connectors.
	Improper jumper or DIP switch settings	Verify that circuit board jumpers are set as intended. Check DIP switch settings.
	Faulty circuit boards	<ol style="list-style-type: none"> Run power-up self-test sequence. Note errors or failures during tests. Compare LEDs with LED indicator status charts. Note discrepancies. Replace faulty PC boards and rerun self-test.



CAUTION: Don't remove or install any connector while power is turned on. Doing so will damage circuit boards or hard disk drive, and void warranty.

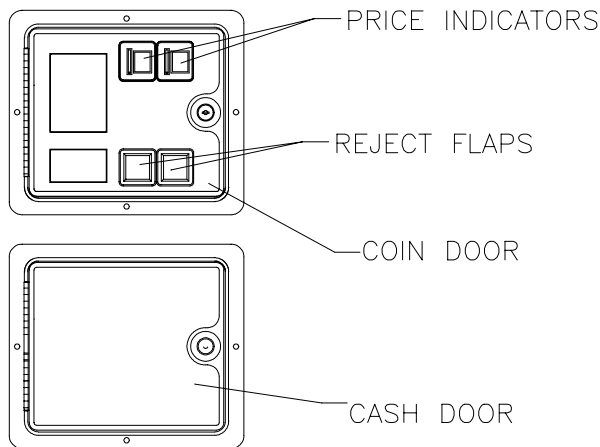

Front View Of Coin Door

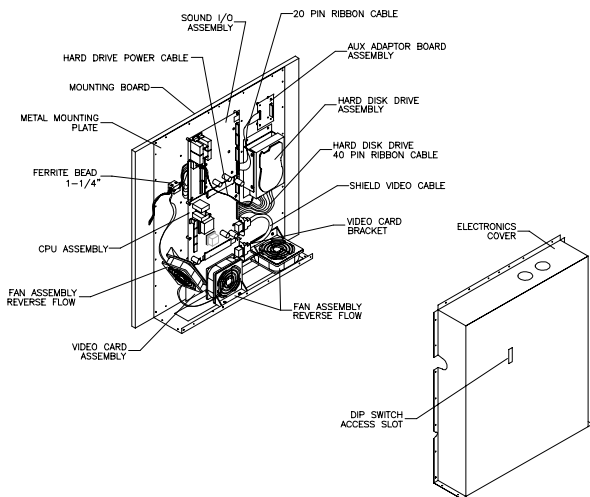

Interior View Of Electronics

VGM Startup Troubleshooting Table, *continued*

SYMPTOM	CAUSE	REQUIRED ACTION
<ul style="list-style-type: none"> VGM (<i>video game machine</i>) doesn't start. VGM accepts currency or tokens. Audio and video are present. 	Faulty coin mechanism	<ol style="list-style-type: none"> Unlock and open coin door. Check each currency acceptor to assure proper mounting. Verify that each release latch is closed and locked. Does mechanism accept and reject currency correctly? Test mechanism with good and bad coins. Inspect to see if external acceptor indicators (Pricing, Flashing Arrows, etc.) are lit. Verify that each acceptor operates properly by placing it in working VGM. Replace bad parts.
	Faulty switches	<ol style="list-style-type: none"> Enter Menu System by pressing and holding TEST MODE switch inside coin door. From Main Menu, choose CONTROLS TEST. Use tests to confirm operation of each switch. Assure that no loose parts or wires are caught in switch contacts. Check for continuity in each suspect switch connection (Common to Normally Open or Common to Normally Closed). Replace faulty switches (bent levers, broken actuators, etc.).
	Faulty wiring	<ol style="list-style-type: none"> Assure that no wires are caught in hinges, latches or switch contacts. Check wiring continuity from circuit board connectors to acceptors. Repair faulty wiring.

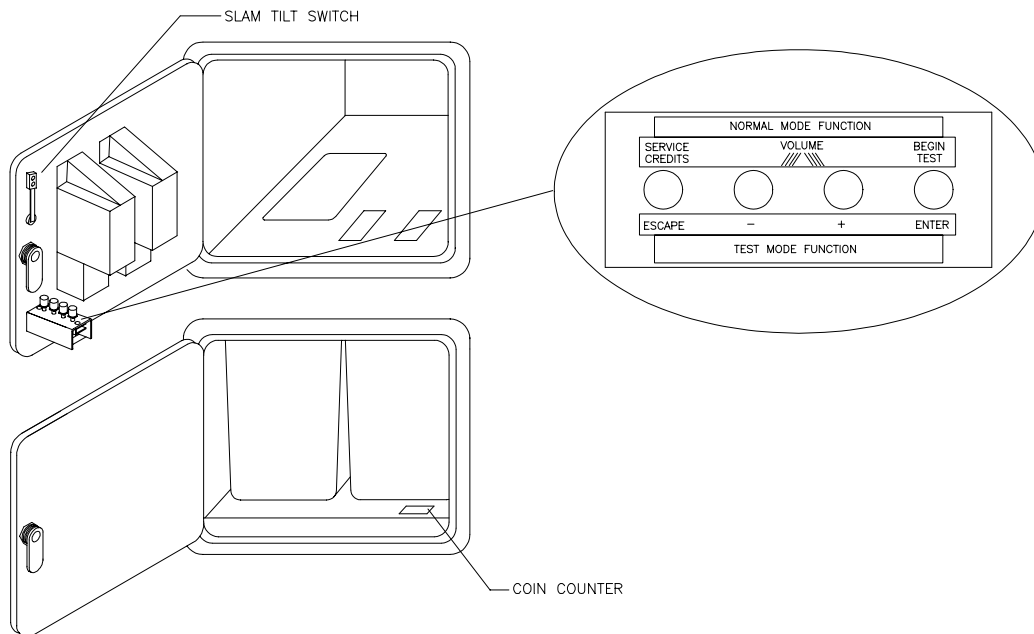

Interior View of Coin Door and Cash Door

Audio Troubleshooting Table

SYMPTOM	CAUSE	REQUIRED ACTION
<ul style="list-style-type: none"> No audio Video is present VGM (<i>video game machine</i>) appears to operate normally 	Improper volume setting	<ol style="list-style-type: none"> From Main Menu, choose VOLUME LEVEL. Check that Attract Music is on (enabled). Verify that all volume levels are set well above zero. If necessary, change levels to make VGM audible.
	Faulty SIO Board	<ol style="list-style-type: none"> From Main Menu, enter Diagnostics Menu. Select SOUND SUBSYSTEM TEST. Test checks entire sound system. Run power-up self-test sequence. Note errors that VGM finds during tests. Compare Sound I/O Board (SIO) LEDs with LED indicator status charts. Note discrepancies. Verify proper operation of SIO Board by placing it in working VGM. If board is faulty, replace it.
<ul style="list-style-type: none"> Constant low hum from all speakers. 	Faulty wiring	<ol style="list-style-type: none"> Check that cabinet wiring is correct for this VGM. Verify that cabinet wiring provides separate wires (not common return) for each speaker. Check connection of all cabinet ground wires. Repair faulty wiring.
	Faulty power supply	Using 2 Volt AC setting on digital voltmeter, measure voltages at speaker terminals. Any reading indicates ripple or noise. In that case, service power supply.
<ul style="list-style-type: none"> Audio is distorted, muffled or has missing frequencies. 	Faulty or improper speaker	<ol style="list-style-type: none"> Turn off VGM power. Remove grilles and check speakers. Assure that speakers are full range (100 to 10,000 Hz) and rated for at least 20 W. Woofers must be rated for at least 40 W. Verify proper speaker operation by connecting speaker in question to working VGM. If speaker is faulty, replace it.
	Faulty wiring	<ol style="list-style-type: none"> Multiple-speaker installations: Check for reversed wires at one speaker. Weak low frequencies and thin or hollow sound quality is symptom of incorrectly phased speakers. Sound tests may not detect this condition, but you can hear it during VGM operation. Repair faulty wiring.
<ul style="list-style-type: none"> Dead sound channel 	Faulty speaker	<ol style="list-style-type: none"> From Main Menu, choose SOUND TEST. Recheck speakers with audio signals in test. Verify proper speaker operation by connecting speaker in question to working VGM. If speaker is faulty, replace it.
	Faulty circuit board	<ol style="list-style-type: none"> From Main Menu, enter Diagnostics Menu. Select SOUND SUBSYSTEM TEST. Test checks entire sound system. Run power-up self-test sequence. Note errors that VGM finds during tests. Compare circuit board LEDs with LED indicator status charts. Note discrepancies. Verify SIO Board operation by connecting board to working VGM. If board is faulty, replace it.
	Faulty wiring	<ol style="list-style-type: none"> Verify that cabinet wiring is correct. Assure that all speakers connect to audio wires. Check for broken or shorted wires. Repair faulty wiring.

Joystick Troubleshooting Table

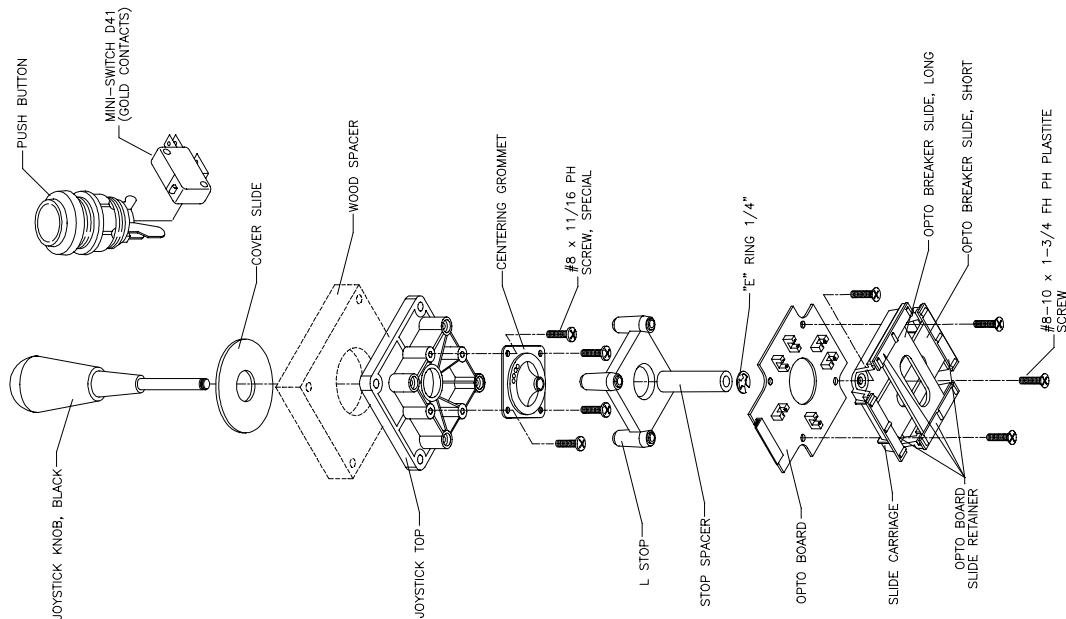

SYMPTOM	CAUSE	REQUIRED ACTION
<ul style="list-style-type: none"> • Players complain that joystick operates erratically or unreliably • Game starts normally 	Faulty switch	Enter game Menu System by pressing and holding TEST MODE switch inside coin door. From Diagnostics Menu, choose SWITCH TEST. Operate joystick in question. Check for proper readings of up, down, left and right.
	Faulty switch wiring	<ol style="list-style-type: none"> 1. Check for wires caught in door hinges, latches or switch contacts. 2. Verify that harness connectors are attached and fully seated. 3. Assure that joystick switches connect properly to control input wires. 4. Reconnect loose cables. 5. Check joystick cable ground connections. 6. Check that cabinet wiring is correct for this VGM (<i>video game machine</i>). 7. Repair faulty wiring.
	Faulty mechanical parts	<ol style="list-style-type: none"> 1. Inspect joystick for: Missing, loose or damaged parts, torn rubber T-band, etc. 2. Replace bad parts.
	Dirty optos	Clean dust out of optos with swab and cleaner. <i>Don't apply cleaner directly into opto. Never use solvents!</i>
	Faulty joystick fuse	<ol style="list-style-type: none"> 1. Check fuses on I-40 Joystick Interface Board inside player control panel. Each joystick has its own fuse. 2. Replace bad fuses.
	Faulty joystick electronics	<ol style="list-style-type: none"> 1. If joystick fuses are okay, install joystick in working VGM (<i>video game machine</i>) and retest it. 2. If joystick still doesn't work, replace it.
	Faulty I-40 Joystick Interface Board	<ol style="list-style-type: none"> 1. If joystick works in second VGM, I-40 Joystick Interface Board may be bad. 2. Replace board and retest joystick.



Joystick Parts

Video Troubleshooting Table

SYMPTOM	CAUSE	REQUIRED ACTION
<ul style="list-style-type: none"> • Monitor appears non-functional • Audio is present • VGM (<i>video game machine</i>) controls operate normally 	Power problem	Verify connection of AC Power to video monitor. Inspect CRT neck in dim light. Glowing filament near CRT base proves that some monitor circuits receive power. Still, voltages or signals may not be normal.
	Faulty wiring	<ol style="list-style-type: none"> 1. Turn off VGM power. Verify that video signal and Remote Adjustment Board connectors seat properly on Video Monitor Board. 2. Assure that video cables connect to circuit boards. 3. Assure that no wires are caught on chassis or mounting brackets.
	Improper monitor adjustments	<ol style="list-style-type: none"> 1. Check that BRIGHTNESS (intensity) and CONTRAST are set above their minimum levels. 2. If necessary, adjust these settings.
	Faulty monitor circuitry	<ol style="list-style-type: none"> 1. Examine AC line fuse on Video Monitor Board. If fuse is faulty, replace it with identical fuse. 2. If fuse is good: Verify that video monitor operates correctly by placing it in working VGM. 3. If monitor is bad: Check monitor power supply. 4. If power supply is good: Check monitor horizontal output transistor and related circuitry.

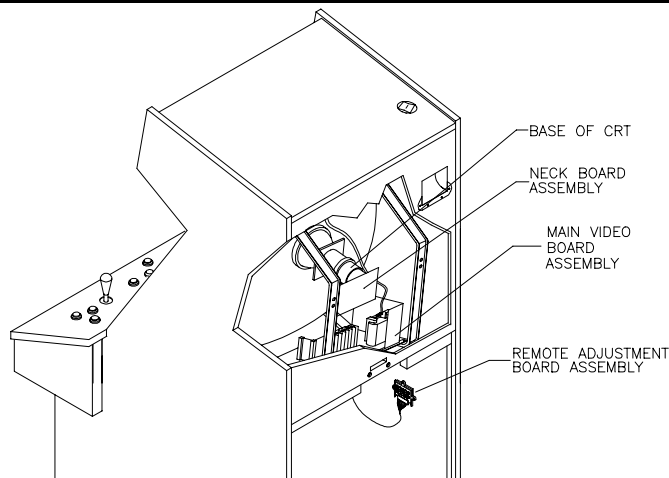

	<p>WARNING: HIGH VOLTAGE. VGM monitors generate and store potentially lethal high voltages. Avoid touching any part of the monitor until power has been off for some time. A picture tube can maintain a hazardous charge for up to several days. Only qualified technicians should service monitors. Turn off the power, unplug the VGM and discharge the CRT before attempting service. Even properly discharged tubes can revert to a highly charged state, <i>without reapplication of power.</i></p>
	<p>WARNING: In normal operation, the monitor doesn't require isolation from AC line voltage. During bench servicing, you may need to operate the monitor outside the cabinet. If you do, <i>isolate the monitor from line voltage with an isolation transformer.</i></p>
	<p>CAUTION: Don't operate the monitor without the Remote Adjustment Board.</p>



Typical Cutaway Rear View

Video Troubleshooting Table, *continued*

SYMPTOM	CAUSE	REQUIRED ACTION
<ul style="list-style-type: none"> • Game screens don't appear • No audio • Power-up self-test runs 	Improper components	<ol style="list-style-type: none"> 1. Verify that hard disk drive is correct for this VGM (<i>video game machine</i>). Label on drive records manufacturer name, assembly number and program version. 2. Verify that circuit boards are correct for this VGM. Label on each board records manufacturer name, assembly number and hardware version. 3. Verify that ROM instruction set is correct for this VGM. VGM set only has one ROM. Label on ROM records assembly number and software version. 4. Replace improper ROMs with correct ones.
	Hard drive problems	<ol style="list-style-type: none"> 1. Turn VGM on. Immediately look <i>under</i> hard drive. Hard Drive Activity LED flashes if drive is operating properly. 2. Allow VGM to load normally. Note and record any error messages that occur during self-test. 3. Remove hard drive and install it in working VGM. If symptom recurs there, hard drive is faulty. Replace it.
<ul style="list-style-type: none"> • Blotches of color appear on screen 	Picture tube aperture mask is magnetized	Remove diskettes from room. Demagnetize monitor with external degaussing coil. Take care not to magnetize neighboring VGMs. Monitor may be on or off for this procedure.
<ul style="list-style-type: none"> • White areas in center of screen appear tinged with color • Object edges have fringe of one or more colors 	Picture tube purity or static convergence is out of alignment	<ol style="list-style-type: none"> 1. Turn on VGM (<i>video game machine</i>). 2. Press and hold TEST MODE to enter Menu System. At Main Menu, select Monitor Tests Menu. Run through Crosshatch, Red, Green and Blue screens to find clearest display of problem. 3. Display screen with greatest problem. 4. Display Crosshatch Screen. Locate purity and static convergence ring magnets on back of monitor neck. Watch screen in mirror. Adjust magnets to minimize problem. Follow instructions from monitor manufacturer. 5. Display Crosshatch Screen. Touch up adjustments while watching screen in mirror.
<ul style="list-style-type: none"> • Background of Attract Mode screens seems out of sync • Words on screen read OK 	Medium resolution monitor, and DIP switch set for low resolution	<ol style="list-style-type: none"> 1. Press and hold TEST MODE to enter Menu System. At Main Menu, select Diagnostics. Then select DIP Switch Tests Menu. 2. Locate DIP switch bank U12 on the Sound I/O Board. 3. Turn off switch 2. 4. Reenter Attract Mode and check screens.

	<p>CAUTION: Don't operate the monitor without its Remote Adjustment Board.</p>
	<p>WARNING: HANDLE FLUORESCENT TUBE AND CRT WITH CARE. If you drop a fluorescent tube or CRT and it breaks, it will implode! Shattered glass can fly eight feet or more from the implosion.</p>

Video Troubleshooting Table, *continued*

SYMPTOM	CAUSE	REQUIRED ACTION
<ul style="list-style-type: none"> White areas at screen edges appear tinged with color Dots at screen edges appear oval or cylindrical 	Picture tube dynamic convergence is out of alignment	Have service bureau dynamically reconverge monitor. This procedure requires removing and repositioning yoke. Service bureau must follow instructions from monitor manufacturer.
<ul style="list-style-type: none"> Video tears or rolls, or has black bar down middle of screen Video may appear as colored bars of dashed lines 	Improper sync signals	<ol style="list-style-type: none"> Check to see if Video Board puts out type of sync that your monitor requires. Adjust sync for monitor you're using: On SIO Board, set DIP switch bank U12, switch 2. Off = medium resolution (default); on = low resolution. Verify that jumpers are set correctly for monitor. If necessary, add or remove video sync jumper at Sound I/O Board jumper block J2. With no pins connected (or pins 2 and 3 connected), board outputs positive sync. With pins 1 and 2 connected, board outputs negative sync.
	Faulty wiring	<ol style="list-style-type: none"> Check connectors and cables for wiring continuity. Video cables connect graphics card to circuit boards, and then to video monitor. Assure connection of all cabinet ground wires, especially at video monitor chassis. If you find faulty wiring, repair it.
	Faulty monitor circuitry	<ol style="list-style-type: none"> Check video monitor operation by connecting it to working VGM (<i>video game machine</i>). Assure that monitor is correct type for this VGM. Monitors with wrong resolution can't lock sync. If you have wrong type monitor, replace it.
	Electromagnetic fields	Move cabinet far away from machines, appliances, or competitors' VGMs.
<ul style="list-style-type: none"> Missing colors 	Faulty wiring	<ol style="list-style-type: none"> Check connectors and cables for wiring continuity from circuit boards to video monitor. Repair faulty wiring.
	Faulty monitor color drive circuitry	Verify that video monitor operates correctly by connecting it to working VGM.
<ul style="list-style-type: none"> One color is dimmer or brighter than others Whites appear tinted everywhere on screen 	Maladjusted color bias pots	<ol style="list-style-type: none"> Turn on VGM (<i>video game machine</i>). Enter Monitor Tests Menu. Watch Color Bars screen in mirror. Adjust three bias pots for best colors. (Most monitor neck boards include these pots.) Also check White Screen. Touch up controls. If whites still seem tinted, have service bureau rejuvenate picture tube.
<ul style="list-style-type: none"> Picture is dim or faded 	Maladjusted BRIGHTNESS pot or subnormal picture tube emission	<ol style="list-style-type: none"> Watch Color Bars screen. Adjust BRIGHTNESS and CONTRAST pots for greatest number of grays. You'll find these pots on Monitor Remote Control Board, behind coin door. If pots have no effect, have service bureau rejuvenate picture tube.

Video Troubleshooting Table, *continued*

<ul style="list-style-type: none"> Picture is too narrow 	Maladjusted WIDTH pot	Enter Monitor Tests Menu. Watch Crosshatch Screen while adjusting WIDTH pot for best picture. You'll find this pot on Monitor Remote Control Board, behind coin door.
<ul style="list-style-type: none"> Picture is too short 	Maladjusted HEIGHT pot or damaged vertical circuit	<ol style="list-style-type: none"> Enter Monitor Tests Menu. Watch Crosshatch Screen while adjusting HEIGHT pot for best picture. You'll find this pot on Monitor Remote Control Board, behind coin door. If pot has no effect, service vertical output circuit.
<ul style="list-style-type: none"> Picture seems shifted to one side 	Maladjusted HORIZONTAL POSITION pot	Enter Monitor Tests Menu. Watch Crosshatch Screen while adjusting HORIZONTAL POSITION pot for best picture. You'll find this pot on Monitor Remote Control Board, behind coin door.
<ul style="list-style-type: none"> Keystone-shaped picture 	Shorted turns in yoke	<ol style="list-style-type: none"> Substitute working yoke. Have service bureau converge monitor. Retest monitor.

Software Update Troubleshooting Table

SYMPTOM	CAUSE	REQUIRED ACTION
<ul style="list-style-type: none"> Update didn't work 	You skipped steps or performed them out of sequence.	Return update components to kit, reinstall original parts in cabinet, and try process again.
<ul style="list-style-type: none"> After update procedure, screen reports lower than latest version 	Installation error may have damaged device.	<ol style="list-style-type: none"> Inspect for bent or broken pins. If you have another kit, try it. Ask your distributor to check your floppy disk.
<ul style="list-style-type: none"> No Attract Mode screens Board indicators illuminate, but screen is completely blank 	Mismatched boot update version and hard drive.	<ol style="list-style-type: none"> Once you've updated disk drive, CPU instructions must be at correct version to make use of new data stored on disk. Be certain that boot ROM device resides in proper socket.
	You may have installed devices in wrong sockets.	<ol style="list-style-type: none"> Install disk ROM. Only use upgrade socket for hard disk drive updates. During game play, upgrade socket must be empty. Load ROM contents onto drive. Remove ROM from game.

	<p>NOTICE: Someday, software updates for your VGM (<i>video game machine</i>) might become available. These upgrades may improve your VGM's performance or add new VGM features. Such upgrades tend to appear sometime after factory first releases VGM. Contact your distributor for information about updates.</p>
---	---

Miscellaneous Problem Troubleshooting Table

SYMPTOM	CAUSE	REQUIRED ACTION
<ul style="list-style-type: none"> Marquee lamp is intermittent or non-functional VGM (<i>video game machine</i>) starts and plays normally 	Faulty fluorescent tube	<ol style="list-style-type: none"> Remove fluorescent tube from its sockets. If you find cracks or darkened ends, install new lamp. Clean tube. Check continuity of both fluorescent tube filaments. Verify that fluorescent tube operates by placing it in working VGM.
	Faulty lamp fixture	<ol style="list-style-type: none"> Verify that lamp pins make good connection with socket contacts. Check ballast for continuity.
	Faulty wiring	<ol style="list-style-type: none"> Measure fluorescent lamp AC voltages. Check wiring and connector continuity from AC power chassis to lamp assembly. If you find faulty wiring, repair or replace it.
<ul style="list-style-type: none"> VGM operates normally Cabinet becomes warm after several hours of use 	Obstructed fan	<ol style="list-style-type: none"> Check bottom and rear of cabinet for blocked airflow. Move VGM away from sources of heat. Turn off VGM power. Remove dust from vent holes with high-power vacuum cleaner.
	Faulty wiring	<ol style="list-style-type: none"> Check fan wiring and connectors. If you find faulty wiring, repair or replace it.
	Faulty fan	<ol style="list-style-type: none"> Check operation of all fans, including power supply fan. If fan is faulty, replace it.
<ul style="list-style-type: none"> Error messages appear on screen 	Faulty hardware	<ol style="list-style-type: none"> Check any assembly (RAM, ROM, Battery, etc.) identified in error messages. Replace faulty parts. Call your authorized distributor for help with unresolved screen messages.

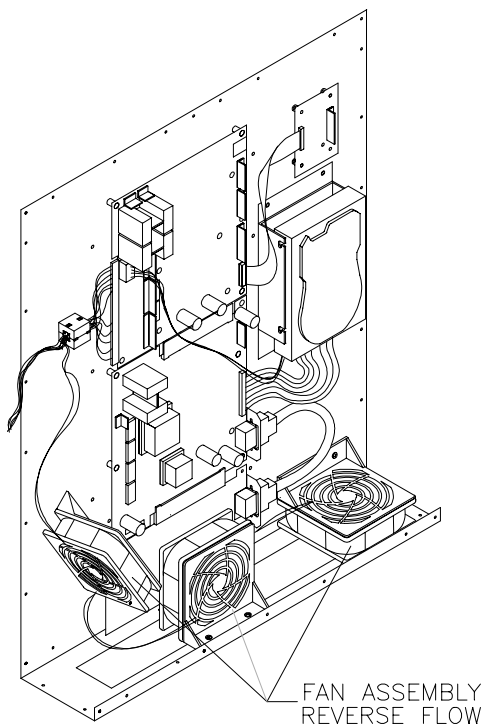

Fan Location and Mounting

WARNINGS & NOTICES

WARNING

- Use of non-Midway parts or circuit modifications may cause serious injury or equipment damage!
- Use only Midway authorized components and parts. Failure to do so will void your warranty and may result in incorrect or unsafe operation. Substitute parts or modifications may void the EMC directive or FCC type acceptance.
- Federal copyright, trademark and patent laws protect this game. Unauthorized modifications may be illegal under Federal law. The modification ban also applies to Midway game logos, designs, publications and assemblies. Moreover, facsimiles of Midway equipment (or any feature thereof) may be illegal under federal law, regardless of whether or not such facsimiles are manufactured with Midway components.

WARNING

Prevent shock hazard and assure proper game operation. Plug this game into a properly grounded outlet. Do not use a cheater plug to defeat the power cord's grounding pin. Do not cut off the ground pin.

WARNING:

A small portion of the population has an epileptic condition that may cause seizures. Affected persons experience seizures while watching some television pictures or playing certain video games. People who have not had seizures may still have an undetected epileptic condition.

If anyone in your family has experienced epilepsy symptoms (e.g., seizures or loss of awareness), consult your physician before using video games.

While children play video games, a parent should observe. Be alert to the following symptoms: Dizziness, altered vision, eye or muscle twitching, involuntary movements, loss of awareness, disorientation, or convulsions. If you or your child experience these symptoms, *discontinue use immediately* and consult your physician.

NOTICE

This kit has been tested. It complies with limits for a Class A digital device, under FCC Rules, Part 15. These limits provide reasonable protection against harmful interference when the equipment operates in a commercial environment. This equipment generates, uses and can radiate radio frequency energy. If not installed and used according to the instruction manual, this equipment may cause harmful interference to radio communications. Operation of this equipment in a residential area is likely to cause harmful interference. If interference occurs, the user must correct it at his own expense.

CAUTION

Installation of this kit does not guarantee compliance with FCC requirements. You are solely responsible, and Midway has no responsibility for FCC compliance of installed kits. Don't install an FCC compliance label on the product until the FCC acknowledges compliance.

NOTICE

You may not reproduce any part of this publication by mechanical, photographic, or electronic means. You may not prepare phonograph recordings of this document. You may not transmit this publication or otherwise copy it for public or private use, without permission from the publisher.

COPYRIGHT & TRADEMARK NOTICE

Entire contents of this manual copyright © 2000 Midway Amusement Games, LLC. All rights reserved. The following are trademarks of Midway Amusement Games, LLC: *Midway*®, *SportStation*™, *NBA Showtime*™, *NFL Blitz 2000 Gold Edition*™. ©2000 NBA. © 2000 NFLP. Team names and logos are trademarks of indicated teams. The NBA logo is a trademark of the National Basketball Association. Officially Licensed Product of the National Basketball Association. The NFL shield, Super Bowl and Pro Bowl are trademarks of the National Football League Players. The *Players Inc.* logo is a registered trademark of the NFL Players. The NBC logo is a registered trademark of the National Broadcasting Company.

FOR SERVICE

Call your Authorized Midway Distributor.