

**CAPCOM**  
CAPCOM U.S.A., INC.

**LEGENDARY**  
**WINGS**™

**Instruction Manual**



## Before You Get Started . . . Stop!

1. Does your **new game** package include all listed parts? (Is it complete?)
2. Is the game you have chosen to transform able to supply all the required voltages for the **new game**?  
**Note:** Some games, (i.e. Ms. Pac Man, Galaxian, etc.) regulate their voltages on the main P.C.B. This makes the existing power supply inefficient. These games will require a change in power supply for your **new game**. Many game supply houses can offer you a switching regulated power supply for a relatively low cost.
3. Is the monitor configuration compatible? In most games it is rather difficult to change the monitor from a vertical mount to a horizontal mount. We recommend you choose a game cabinet with the same mount as your **new game** requires.
4. Do you have the necessary tools? (See the recommended tool list)

## Caution

### F.C.C. Regulation Compliance

The P.C. board cage supplied with this new game kit must be utilized and terminated to ground at the time of installation.

This is to avoid radio frequency radiation and comply with the limits for a class "A" computing device pursuant to sub-part "J" of part 15 of F.C.C. rules, which are designed to provide reasonable protection against interference when operated in a commercial environment.

Operation of this equipment in a residential area is likely to cause interference — in which case, the user at his own expense, will be required to take whatever measures may be required to correct the interference.



# Installing and Servicing Your



## New Game Package

### Table of Contents

New Game Package Contents .....	2
Power and Monitor Requirements .....	2
Recommended Tools and Supplies .....	3
Dip Switch Tables .....	3&4
Game Operation .....	5
Installation Procedures .....	6
Helpful Hints .....	12
Control Panel Positioning .....	13
Main Harness Connections .....	14



## **NEW GAME PACKAGE CONTENTS**

<ul style="list-style-type: none"> <li>1 Main Printed Circuit Board (PCB)</li> <li>1 PCB Cage (FCC Required)</li> <li>1 Set Legs, Bolts, &amp; Spacers</li> <li>1 Connecting Wire Harness</li> <li>2 Eight-Way Joystick</li> <li>6 Player Button Assemblies</li> </ul>	<ul style="list-style-type: none"> <li>1 Marquee</li> <li>1 Control Panel Overlay</li> <li>1 Plex Control Cover</li> <li>1 Set Side Graphics</li> <li>1 Set Play Instructions &amp; Function Labels</li> <li>1 Service and Installation Manual</li> </ul>
--	---

**Note:** Replacement accessories available through your exclusive **Capcom** distributor.

<b>POWER REQUIREMENTS</b>		<b>MONITOR REQUIREMENTS</b>
+5 VDC	5 amp	Vertical Mount Raster Scan Negative Composite Sync
+12 VDC	1 amp	

# Recommended Tools and Supplies

**CAPCOM new game** package.

Phillips and Slot Screwdrivers  
Socket Set  
Enthusiastic Attitude  
Wire Cutters and Strippers  
Pliers or Channel Locks  
Planning and Careful Thought  
Electric Drill  
3/32" • 1/4" • 7/16" Drill Bits  
1/4" Plex Bit  
1-3/16" Chassis or Sheet Metal Punch  
1 1/4" Plex Hole Saw  
Glass of Water and a Snack  
Small File  
Razor Knife and Sharp Blades  
Straight Edge  
Patience  
Common Sense

Painting Supplies (if you do your own painting)

Paint Brush and Paint (don't forget the primer)  
Paint Roller and Pan  
Sand Paper  
Putty Knife and Wood Putty  
A Good Night's Sleep  
Staple Gun and Staples  
Soldering Iron and 60/40 **Resin Core** Solder  
Vacuum Cleaner  
Assorted Fastening Hardware  
Shrink Tubing: 3/32" • 1/8" • 3/16"  
Masking Tape  
3 1/2" OR 4" Wire Ties  
Spray Window Cleaner and Rags  
(baby diapers work GREAT!)

## Dip Switch Tables

### Optimize Your Profits

**Thorough Research shows that two and a half minute games both satisfy players and also keep the quarters flowing.**

If games aren't running about two and a half minutes long, then collections probably aren't at their peak. You'll want to tailor your game to your location. The trick is to adjust a few DIP switches. (See the chart in this book.) It's easy!

DIP sw - LEGENDARY WINGS

**DIP sw A**

ITEM	DESCRIPTION	1	2	3	4	5	6	7	8
COIN 1	1 COIN / 1 CREDIT	OFF	OFF						NOT USED
	1 / 2	ON	OFF						
	1 / 3	OFF	ON						
	2 / 4	ON	ON						
COIN 2	1 COIN / 1 CREDIT			OFF	OFF				
	2 / 1			ON	OFF				
	3 / 1			OFF	ON				
	4 / 1			ON	ON				
NUMBER OF PLAYERS	3 PLAYERS					OFF	OFF		
	4 PLAYERS					ON	OFF		
	5 PLAYERS					OFF	ON		
	6 PLAYERS					ON	ON		
SCREEN FLIP	NORMAL							OFF	
	FLIP							ON	

**DIP sw B**

ITEM	DESCRIPTION	1	2	3	4	5	6	7	8
BONUS POINTS	1 ST 20,000 AND EVERY 50,000	OFF	OFF	OFF					NOT USED
	// 20,000 // 60,000	ON	OFF	OFF					
	// 20,000 // 70,000	OFF	ON	OFF					
	// 30,000 // 60,000	ON	ON	OFF					
	// 30,000 // 70,000	OFF	OFF	ON					
	// 30,000 // 80,000	ON	OFF	ON					
	// 40,000 // 100,000	OFF	ON	ON					
	// NON	ON	ON	ON					
CONTINUE MODE	YES				OFF				
	NO				ON				
SOUND FOR DEMONSTRATION	YES					OFF			
	NO					ON			
DIFFICULTY (LEVEL)	NORMAL (LEVEL 10)						OFF	OFF	
	EASY (LEVEL 0)						ON	OFF	
	DIFFICULT (LEVEL 20)						OFF	ON	
	VERY DIFFICULT (LEVEL 30)						ON	ON	



## Story:

The human race was about to achieve the evolution from an ancient civilization to a state of millenium with the help of "DARK", a super powerful computer left by spacemen long ago. "DARK" suddenly began to malfunction. The world was in a panic. The human race was on the brink of extinction. "ARES", God of war, gave two young men Wings of Love and Courage and entrusted them with the survival and future of the human race. Time is of the essence. Destroy "DARK". Take wings, legendary wings.

## Game Operation:

### Instructions

Legendary Wings is a 2-PLAYER simultaneous-play game with a Buy-In feature and Continuation Mode.

Attack flying objects and collect POW hidden in domes on the ground to gain power.

POW 1 - Speed Up.

POW 2 - Speed up/two shots at once.

POW 3 - Continuous firing ground missiles.

POW 4 - Shoot in three directions.

POW 5 - Psycho Power Shot

any enemy can be destroyed by a single shot.

**AVOID BEING SWALLOWED BY GIANT STATUE.**

If swallowed:

Pressing  
FIRE  
button

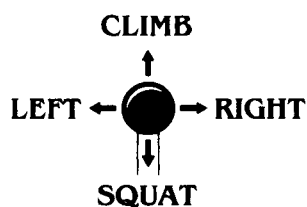

Pressing  
MISSILE/  
JUMP  
button

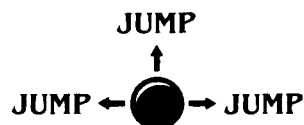

# Installation Procedures

## Something To Think About

Your final product will be a **new game**.

You have made a wise decision to transform a game that has seen better days in the all important cash box into a **new game**. This is by far the most cost effective alternative to maximize the return of your initial investment. All you provide is the cabinet with a power supply and a monitor. Oh yes, you will need a touch of elbow grease. And that's it! We provide the rest. The end result is . . . a **new game** at a very low cost.

**Fact:** Spend a little time on the cabinet's appearance (i.e. marquee, control panel and cabinet graphics). With a little paint, some wood putty and new lights, you will raise the profits of any game. . . especially with the introduction of a **new game** package.

The **new game** look should always apply to the inside of your game as well as the outside. A few wire ties and shrink tubing on your harness; some fastening hardware on your subassemblies and a sweep with the ol' vacuum cleaner will ensure that unnecessary *glitches* do not occur.

**Remember:** You are creating a **new game** .

If you have any questions or just need some advice on any of your **new game** transformations, don't hesitate in giving a member of our technical staff a call.

## Let's Get Our Hands Dirty

### Preparing the Original Game for the New Game

Remove the following:

1. Main logic board(s)
2. Control panel
3. Monitor plexiglass
4. Monitor Bezel
5. Marquee
6. Graphics

I would recommend painting your cabinet to give it a fresh new look. (If it is geographically inconvenient to make use of our facilities, you may consider having an auto body shop take care of your painting needs.)

If your cabinet has wood grain sides; remove old graphics and adhesive (adhesive may be removed with **lacquer** thinner.

If you intend to use your original plexiglass, be sure it is in mint condition or it should be replaced.

Thoroughly clean out your cabinet.

# Time To Install Your New Goodies

**Before You Start . . . Remember DO NOT  
Do This Work With The Power On!**

## Logic P.C.B. Cage

Mount the logic cage securely (away from power supply).

- A Mark and drill pilot holes (3/32").
- B Place the logic cage (bottom) over the holes and secure it with the supplied wood screws.
- C Install the P.C.B. into the logic cage. Use feet and spacers supplied and adjust them so that the screws will go through the slots into the cage bottom.  
**Note:** Leave the cage cover off until you have attached the entire wire harness and have tested the game for proper operation.

## Wire Harness

Attach the wire harness connector to the main logic board. **CAUTION:** Sometimes the connector is not keyed and it is very easy to install it reversed on the logic board. Even if it is keyed, always **triple check** to be sure the wire inputs were connected correctly to the connector and the connector to the logic board.

## Connecting the Wire Harness to the Existing Wires

When you hook up the control panel, power supply, monitor or other subassemblies that remain in the game cabinet to your new wire harness, try and use their existing secondary connectors.

1. Cut the original wire approximately three inches from the original connector. Strip off about one half inch of insulation.
2. Solder the new wire designated for that position to the original wire you just stripped.

**Warning:** DO NOT JUST TIE THE WIRES TOGETHER. THIS CAN CAUSE NAGGING INTERMITTENT PROBLEMS THROUGH LOOSE CONNECTIONS OR OXIDATION OR BOTH. **Always take the time to do it right.**

3. Melt shrink tubing around all your in-line wire connections. Do not use electrical tape. Tape could unravel over a period of time due to the cabinet heat and cause you a great deal of trouble.
4. Use wire tie wraps, and secure the cable to the cabinet whenever it seems necessary. Remember this is a **new game**, not a sloppy conversion.

## Power Wires

1. Connect the wires that are designated for your power supply. You will need a supply of +5V, +12V & ground. Your **new game** package may not require all of the voltages that were used in the original game. Tie off any unused wires.
2. You will notice that you probably have more than one wire for each voltage. It is a good idea to use all wires supplied (double up if it is necessary). This will help to ensure that you don't overload the edge connector pins and cause them to "burn".

## Monitor Wires

You will be connecting the wires designated for the RED, GREEN & BLUE video guns along with the SYNC & GROUND wires.

### **NOTE . . . CONCERNING SYNC:**

Your **new game** only calls for one sync wire connection, this is called **composite sync** (horizontal and vertical tied together). This composite sync is also **negative**. Most monitors have supply positions for both negative and positive sync. You can check your monitor manual or call our technical department for assistance.

## Speaker Wires

Find the two wires that are designated for the speaker and hook 'em on up.

## Coin Door Wires

1. Connect the designated wires to the coin switches and meter.
2. You can connect your door lamps to the unused –5V power supply. Some games have separate power outputs for the coin door lamps.
3. **Be** sure to clean and lubricate your old coin mechanisms. Keep the money coming in.

## GUESS WHAT?

You are almost done with the electrical connections of your **new game**. All you have left is the control panel wiring. But we are going to hold off on that for right now. We have a few other things we need to do first. So why don't you go ahead and get yourself a drink of water and stretch your legs. When you return, we can take a fresh look at your progress and then move forward.

# Smoke Test

## What Test?

Don't worry. All this means is that you are ready to apply power to the system for the first time and you pray that there will be no smoke from a simple oversight.

You are just about ready to power up the logic board. But first we need to recheck your work.

1. Carefully inspect the game for loose power wires, exposed connections and extra fastening hardware.
2. Make sure the logic board, board cage, monitor and power supply are securely fastened in place.
3. **Double check** the connectors to be sure they are wired and connected properly.
4. Set the dip switches on the logic board to the factory recommendations.

## Time to Apply Power:

1. Look and smell for smoke. (TURN OFF IMMEDIATELY IF ANY IS NOTICED)
2. Listen for game sounds.

If after one minute you have not heard any sounds:

- A) Check for proper dip switch settings.
- B) Adjust volume control and check speaker connections.
- C) Check the +12V power supply to the logic board.

**NOTE:** If you do get sounds, but they are a little fuzzy, switch the wires around on the speaker. See page 12 for more helpful hints.

3. How is the monitor image?

### A) Is the picture in sync?

If your picture has the top and bottom halves of the screen reversed and it will not stop rolling, change your sync polarity on the monitor. (Positive to negative).

If your monitor does not have dual polarity positions for sync, then you will need to reverse the sync yourself by installing a simple one I.C. circuit between the logic board and the monitor. (The following illustration shows a hookup for both **composite** and **separate** syncs.

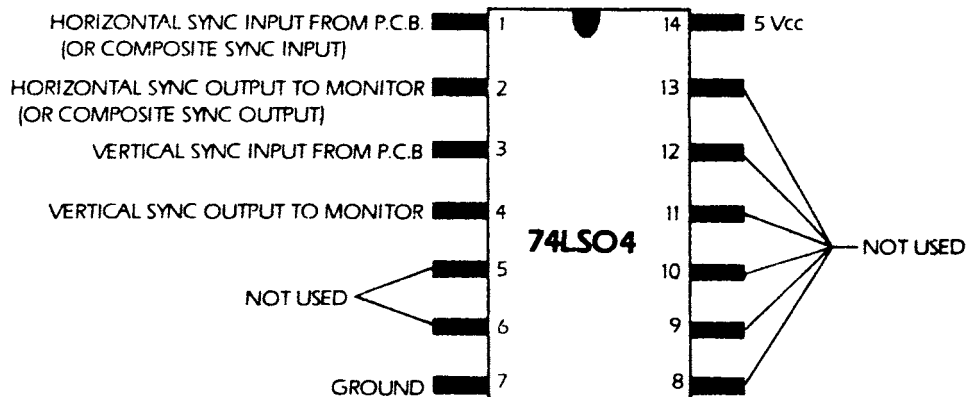

### B) Now how's your picture?

- Is it centered?
- Is it too bright or dim?
- Is it in focus?

Check your monitor manual for these adjustments. If your screen looks "off", then your **new game** transformation may have been in vain. So let's take the time to make the monitor look great.

### C) Is the picture upside-down?

Dip switch 3 on switch bank "B" should solve your problems.

# Control Panel Assembly

1. Remove the buttons, joysticks and wire harness and put them aside for now. Do not remove the original panel overlay until the new holes have been drilled.
2. Mark positions on the panel for the new holes.

**CAPCOM** supplies a clear 1/8" thick piece of plexiglass with every **new game** package to cover the control panel. We feel that your **new game** investment is well worth protecting . . . and the control panel is the first place to show wear and tear.

  - You will need to cut this piece to size. Use the control panel as a template.
  - Use a razor knife to score the plexiglass **deeply**. Then use a pair of pliers to break away the extra plexiglass.
3. Now drill the holes in your panel that you have marked off for the *buttons, joystick and bolts*.

**Hint:** For best results, use a chassis or sheet metal punch for button holes.
4. Drill the same holes on your plexiglass panel protector. Once again use your panel as a template.

**Hint:** To avoid chipping while you are drilling the holes, place the plexiglass securely on a soft wood surface and use a plexiglass drill bit and hole cutter.
5. The holes are now all cut. Smooth them out on your panel and plexiglass with a fine toothed file.
6. Remove the original graphics overlay from the panel. Clean up the panel and install your **CAPCOM** graphics.

**Make It Easier:** Peel the top half of the protective backing off of your graphics. Start from the center and smooth out your overlay. Make sure you have about an inch extra coming off the top. *No bubbles please*. Now peel off the bottom half and do the same as you did for the top.
7. Adhere the instruction and function labels.
8. Install the Plex Control Cover over your completed **new game** panel.

**Note:** Be sure to bolt the plexiglass securely to the panel.
9. Mount the joystick and the buttons to the panel and wire them up. (Use the existing Panel wiring if possible)

# Marquee Installation

Using the original marquee as a template, Center your **new game** marquee graphics and score the new marquee deeply to fit the cabinet. Break off the excess with pliers.

**Be sure** the light behind the marquee works. Everything should **always work** on a new game.

Take your time ... Don't forget this is going to be a **new game**.

## Side Graphic Installation

1. Be sure sides of game are clean and free of old adhesive, dust, etc.
2. Mark position of decal with erasable pen or pencil (centered on upper half of cabinet).
3. Peel off top 1/4 of decal backing and apply to cabinet with a smoothing motion (use a soft rag). Continue peeling off backing and smoothing.
4. Remove any small bubbles with a pin or razor blade (pop them!)

## Finishing Touches

1. Check the game inside and out for any imperfections. Secure any loose wiring or fastening hardware.
2. Make sure the coin door is tight and the coin mechs are well adjusted. A game is no good to anybody if you can't get a coin into it.
3. Once again go over every step of this **new game** transformation in your mind. Be sure everything is correct and to your liking.
4. Power up the game.
  - A. Check all the coin switches. (Does the coin meter work?)
  - B. Play your **new game** .
    - Are all the player controls working?
    - Are the game sounds present?
    - Is the volume level proper?
    - Are the dip switches set properly?

Well, that's about it. Good Luck.

# HELPFUL HINTS

## Simple audio check for Board: TYPICAL AUDIO CIRCUIT FOR CAPCOM BOARD:

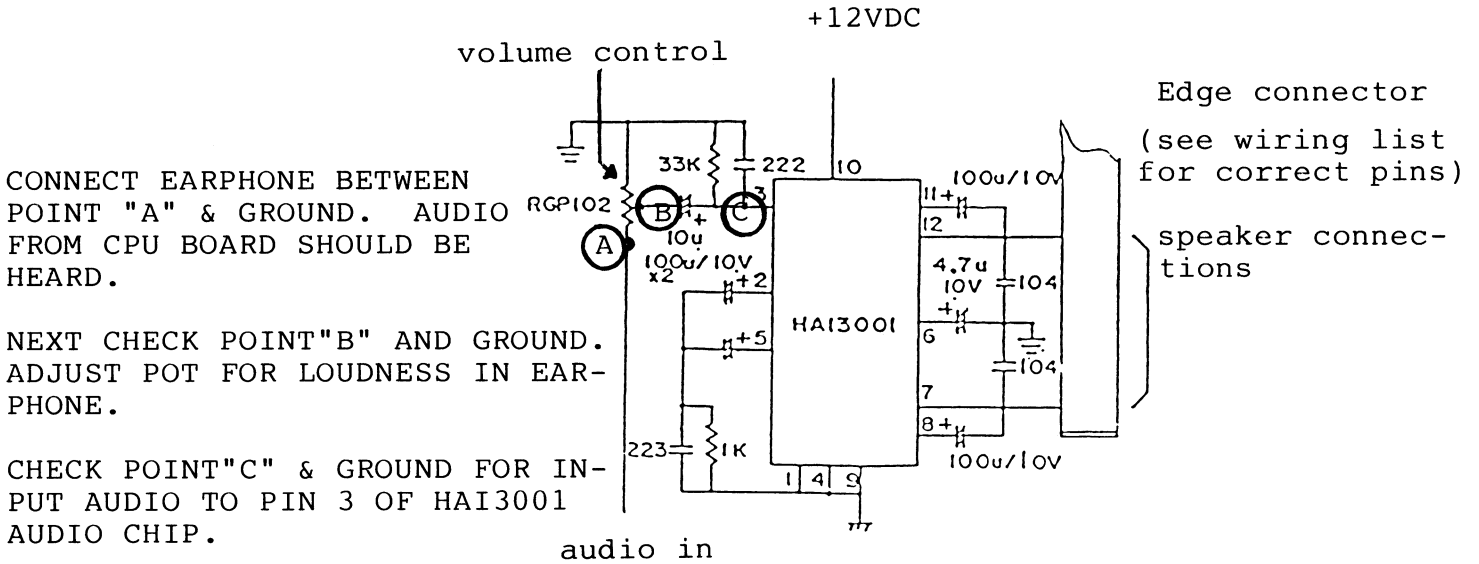

Also make sure Ground from +5VDC and Ground from +12VDC ARE TIED TOGETHER. IF GROUNDS ARE FLOATING, you could have audio problems.

- 1.) You must add a wire from the cathode of D1, to the edge connector pin 22 and z to complete the circuit.

### COUNTER CIRCUITRY MODIFICATION

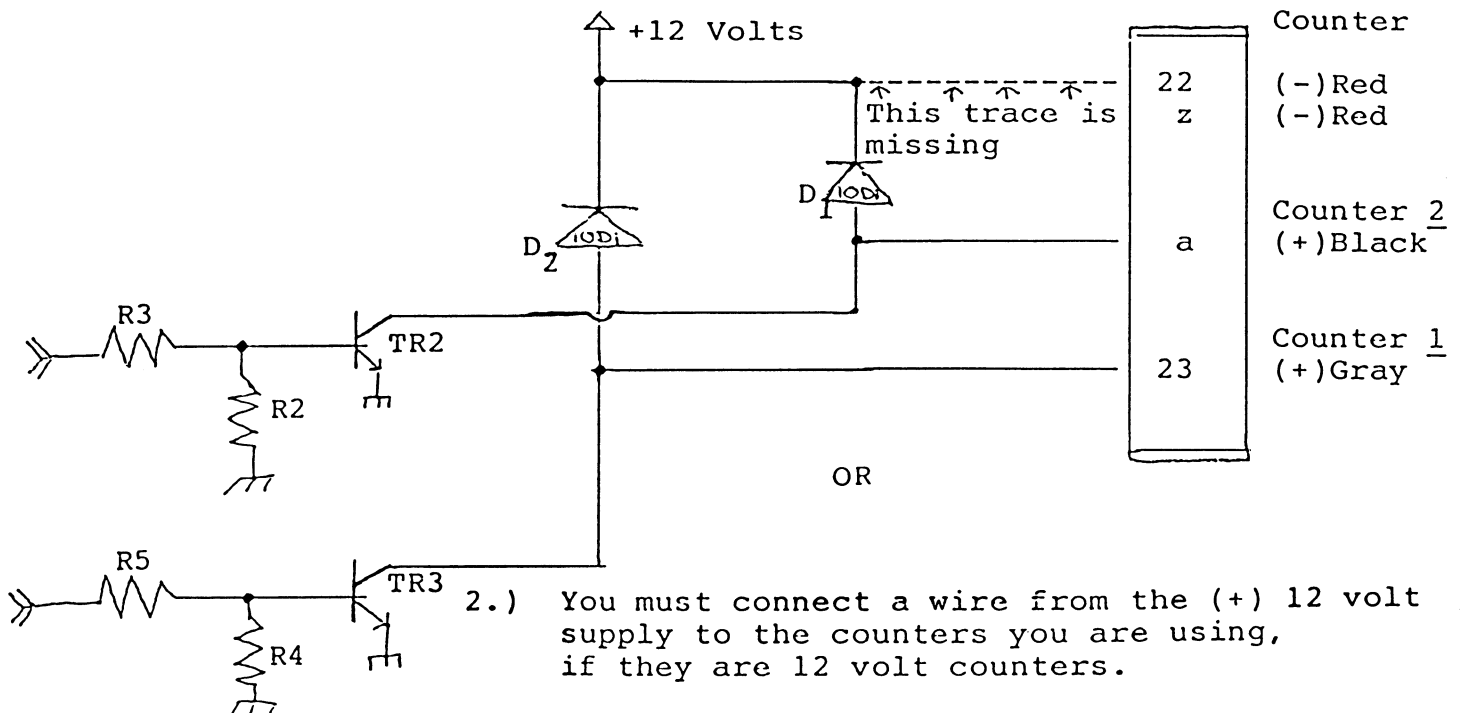



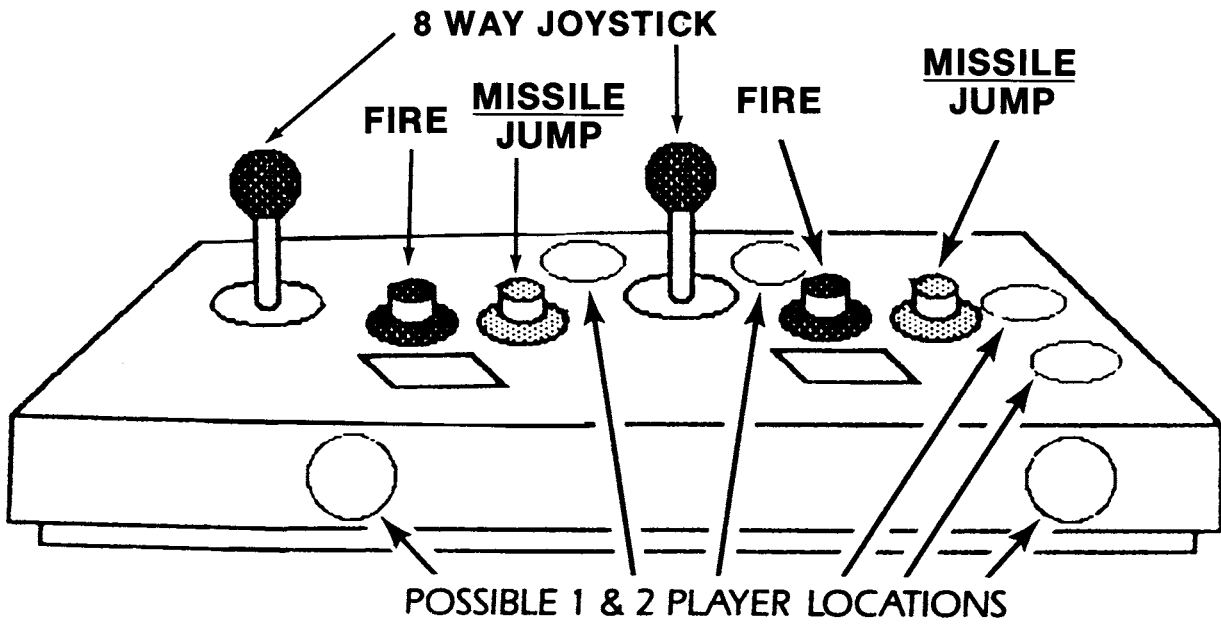

## Control Panel Positions

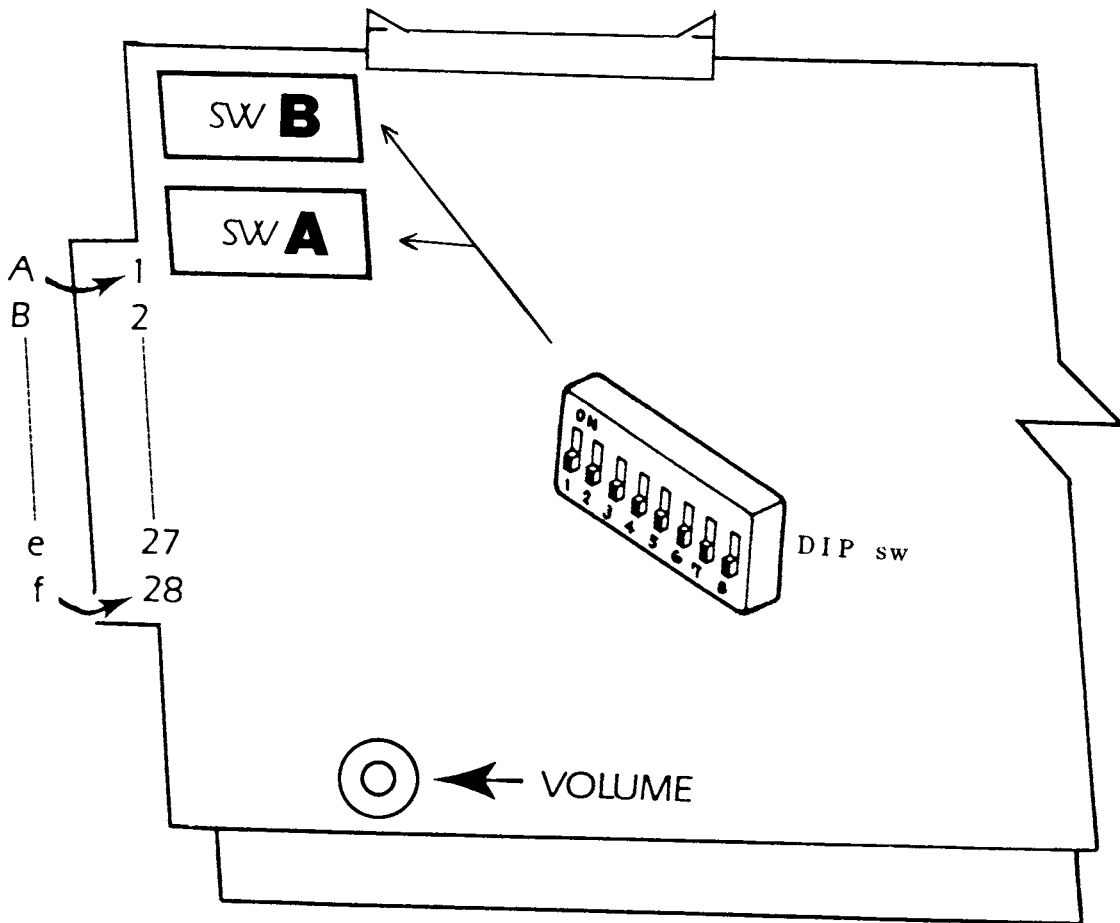

## PCB Layout



Wire Color	Solder Side			Parts Side	Wire Color
Black	Ground	A	1	Ground	Black
Black	Ground	B	2	Ground	Black
Red	+5VDC	C	3	+5VDC	Red
Red	+5VDC	D	4	+5VDC	Red
White	Video Green	E	5	Video Red	White
Yellow	Video Sync	F	6	Video Blue	Yellow
Brown	Not Used	H	7	Video Ground	Brown
	Key	J	8	Key	
Red	2P MISSILE/JUMP	K	9	1P MISSILE/JUMP	Red
Black	2P FIRE	L	10	1P FIRE	White
Blue	2P Up	M	11	1P Up	Blue
Green	2P Down	N	12	1P DOWN.	Red
Gray	2P Left	P	13	1P LEFT.	Blue
Red	2P Right	R	14	1P Right	Black
Brown	Switch Ground	S	15	Switch Ground	Brown
White	2P Select	T	16	1P Select	White
Gray	Not Used	U	17	Not Used	Gray
Violet	Coin 2	V	18	Coin 1	Violet
Blue	Coin Ground	W	19	Coin Ground	Blue
Green	NOT USED	X	20	NOT USED	Green
Yellow	Not Used	Y	21	Not Used	Yellow
Orange	Counter 2 -	Z	22	Counter 1 -	Orange
Red	Counter 2 +	a	23	Counter 1 +	Red
Brown	Speaker -	b	24	Speaker +	Brown
Blue	+12VDC	c	25	+12VDC	Blue
Blue	12V Ground	d	26	12V Ground	Blue
Black	Not Used	e	27	Not Used	Black
Black	Ground	f	28	Ground	Black

2P CONNECTIONS FOR COCKTAIL ONLY (Except 2P SELECT)



1283-C Mountain View / Alviso Rd.  
Sunnyvale, CA 94089  
(408) 745-7081