

INDOOR SOCCER

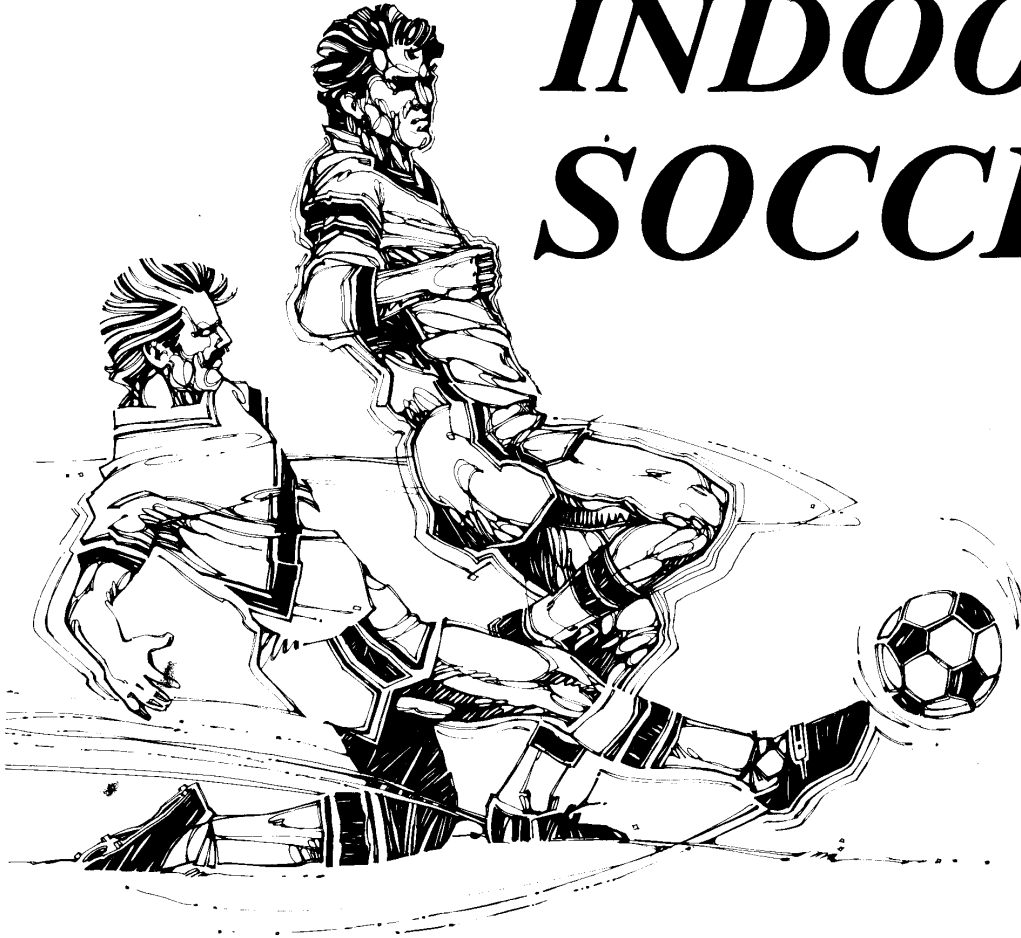

SERVICE MANUAL

UNIVERSAL®



UNIVERSAL U.S.A., INC. INTRODUCES

INDOOR SOCCER

Indoor Soccer is manufactured and marketed as a conversion for coin-operated video games. This manual is designed for the use, maintenance and installation of this product.

Installation, maintenance or repair should only be attempted by qualified service personnel.

Technical assistance is available by calling:

1-800-538-7568 Outside California.

1-408-727-4591 Inside California.

172247 Telex.

Upon receipt of your Universal U.S.A. conversion kit, be sure to verify that all contents are complete and free from defects or damage. Notify your distributor of any discrepancies in the kit as soon as possible.

Your **Indoor Soccer** Conversion Kit includes:

- A) 1 - **Indoor Soccer** P.C.B. (Contained in R.F. shield). UNIVERSAL PART #02-10027-00 (06-10100-00).
- B) 1 - Audio-amplifier P.C.B. UNIVERSAL PART #02-10100-00.
- C) 1 - Main wiring harness assembly. UNIVERSAL PART #03-10127-00.
- D) 4 - WICO/8-way batt handle joystick assembly. UNIVERSAL PART #04-05000-00.
- E) 2 - Push buttons (Complete with housing). UNIVERSAL PART #04-05111-00
04-05202-00.
- F) 1 - 24" x 9" clear control panel plexiglass. UNIVERSAL PART #05-00005-00.
- G) 1 - Set of control panel decals. UNIVERSAL PART #05-27107-00.
- H) 1 - Polycarbonate control panel overlay. UNIVERSAL PART #05-27105-00.
- I) 1 - **Indoor Soccer** Marquis (Title) decal. UNIVERSAL PART #05-27000-00.
- J) 2 - **Indoor Soccer** side decals. UNIVERSAL PART #05-27120-00.
- K) 1 - **Indoor Soccer** instruction decal. UNIVERSAL PART #05-27110-00.
- L) 1 - **Indoor Soccer** license sticker.

Cabinet Requirements

The *Indoor Soccer* Conversion Kit can be installed into any standard cabinet (upright or cocktail). The game is designed to display on any standard horizontally mounted, color (R.G.B.), rastorscan monitor.

Many cabinets allow for the repositioning of monitors from vertical mounted monitor to horizontal mountings. Repositioning of a vertical mounted monitor is a delicate, if not cumbersome, operation and extreme care should be exercised in handling any monitor. It is recommended that the installation of the *Indoor Soccer* Conversion Kit be attempted only on those cabinets in which monitors are presently mounted horizontally or in such cabinets, where design facilitates the repositioning or mounting of monitors to be easily interchangeable. It is not recommended that cabinets be physically altered or any reconstruction of cabinets be done by anyone other than those qualified and having the appropriate facilities to conduct such oprations.

The *Indoor Soccer* P.C.B. will require regulated voltages of +5 and +12 VDC. Most standard power supplies will provide these voltages, therefore the replacement of existing power supply may not be necessary. Along with the monitor and power supply, the control panel, speaker, and coin door need to be retained from the existing cabinet.

Control Panel Installation

Parts furnished with the *Indoor Soccer* conversion kit for the control panel modification are pictures and listed on pages 8 and 9, as well as an installation layout.

Begin removing the existing controls and graphics, then prepare the surface by cleaning and removing any foreign material and debris. Take note of the existing holes in the panel to determine placement of the new controls.

NOTE: Repositioning and drilling holes to install the new controls on the existing control panel may be necessary and require the use of power tools. In the event that such tools are needed, exercise extreme caution. If assistance is required, contact a local Universal U.S.A. distributor.

Apply the polycarbonite overlay to the top of the control panel and trim away any excess material around the edges and holes to be used for the new controls. Attach the indication decals (i.e., joysticks, 1 player, and 2 player) on top of the overlay next to the corresponding holes.

If needed or desired, measure and cut the clear plexiglass furnished with the kit to fit the existing control panel. Drill holes for the controls at 1½ inches in diameter to accomodate the joystick and buttons where needed. Be sure to file or sand away any rough corners around the edges of the plexiglass.

Wiring Installation

All wiring terminations and connections for the *Indoor Soccer* conversion kit are in the secondary or low voltage circuit (less than 42 VDC).

Electrical cautions:

- **Never** attempt installation, connection or electrical terminations with power applied to the unit.
- **Never** disconnect the Printed Circuit Board(s) with power applied.
- **Never** replace any components with anything other than exact replacement parts.

Begin the wiring process by removing the existing P.C.B.(s) and wiring harness(es). Physically secure the *Indoor Soccer* P.C.B. and audio amplifier P.C.B. to the inside of the cabinet. Pin assignment and termination points of the harness assembly are provided on page 6 of the manual.

Termination of the wiring harness can be separated into five (5) basic categories:

1. Power Inputs: +5 VDC, +12 VDC and Ground;
2. Video Outputs: Red, Green, Blue, Video Ground and Sync;
3. Player Controls: Up, Down, Left, Right, Kick, 1st and 2nd Player Start;
4. Coin Door: Left Coin, Right Coin, Slam Switch and +5 VDC (Coin Meter);
5. Audio Output: Speaker.

1. **Power Inputs:** Termination of the voltage leads is probably the most critical and fundamental process of the installation. Extreme caution should be taken to insure correct terminations and proper voltages. The voltage input lines are distinguishable, as 18 gauge wire is used for each. (+5 VDC-Orange at pin #3, +12 VDC-Red at pin #8, and Ground-Black at pin #1). Before proceeding, verify that each input voltage is correct and at the proper designated pin assignment of the P.C.B. connector.

2. **Video Outputs:** Connections can be made by terminating the Red (Pin Z), Green (Pin A), Blue (Pin B) and Video Ground (Pin E) to the corresponding inputs of the monitor. To connect the sync output(s), first determine what inputs are needed by the monitor. The composit sync (White wire at Pin C), can be terminated to the composit sync input of the monitor, if applicable. *Indoor Soccer* will generate a negative composit sync. In most cases where negative horizontal and vertical sync is needed, terminations can be made by connecting the White composit sync line to both negative H & V inputs of the monitor.

If a positive signal is needed, contact your local distributor to obtain a Universal 8300-TV-B Video P.C.B. (This assembly can be used to modify sync signals).

NOTE: The wires at pins #5 (Orange) and #6 (Brown) are designated for vertical and horizontal outputs and are needed only for supplemental modifications.

If the display appears on the screen "Upside-Down" the display can be turned by a dip-switch setting. (Dip-switch A-SW5—See option settings on page 2).

3. **Player Control Inputs:** Player control inputs will be connected at the control panel.

The joystick terminations can be made by connecting the designated wires to corresponding switches on the 8-way joystick supplied in the kit. The wires for each joystick are all color coded as to the function of each switch as follows:

UP - Blue
DOWN - Yellow
LEFT - Purple
RIGHT - Brown
KICK - Red
GROUND - Black

1 PLAYER - Orange wire at pin #21
2 PLAYER - Green wire at pin Y

1 PLAYER JOYSTICK - A & B
2 PLAYER JOYSTICK - C & D

4. **Coin Door & Inputs:** Wiring for the coin inputs can be accomplished by following either of the diagrams on the bottom of page 6. Separate inputs are provided on pins #24 and #25 to allow for the selection of independent coin chute pricing. (For options on price selection, see page 2—dip-switch B).

5. **Audio Outputs:** Begin by soldering the speaker lines to terminals S1 (-) and S2 (+) on the audio amplifier P.C.B., then connect the audio plug on the harness assembly (White 4-pin molex) into the socket (p1-4) on the amplifier unit.

NOTE: To avoid audio distortion, verify that the voltage to the amplifier is regulated at +12 Volts DC.

F.C.C. Compliance:

THIS EQUIPMENT GENERATES AND USES RADIO FREQUENCY ENERGY AND IF NOT INSTALLED AND USED PROPERLY, I.E., IN STRICT ACCORDANCE WITH THE INSTRUCTIONS MANUAL, MAY CAUSE HARMFUL INTERFERENCE TO RADIO COMMUNICATIONS. IT HAS BEEN TESTED AND FOUND TO COMPLY WITH THE LIMITS FOR A CLASS A COMPUTING DEVICE PURSUANT TO *SUBPART J OF PART 15 OF F.C.C. RULES*, WHICH ARE DESIGNED TO PROVIDE REASONABLE PROTECTION AGAINST SUCH INTERFERENCE WHEN OPERATED IN A COMMERCIAL ENVIRONMENT.

OPERATION OF THIS EQUIPMENT IN A RESIDENTIAL AREA IS LIKELY TO CAUSE INTERFERENCE IN WHICH CASE THE USER, AT HIS OWN EXPENSE, WILL BE REQUIRED TO TAKE WHATEVER MEASURES MAY BE REQUIRED TO CORRECT THE INTERFERENCE.

Indoor Soccer P.C.B. is enclosed in a metal R.F. shield to meet the F.C.C. requirements stated above.

To comply with the ruling, it is imperative that the R.F. shield is installed properly. After mounting, make sure that the cage is ***grounded***. With an Ohm meter, conduct a continuity test between the shield and the ground to verify proper installation. Enclosed in the conversion kit is an F.C.C. Warning Sticker. This decal ***MUST*** be placed and maintained on the exterior of the cabinet.

Under **NO** circumstances should this equipment be operated without the Printed Circuit Board properly installed in the R.F. shielding.

I. HOW TO PLAY

- One Player vs. Computer
- Two Player — Two vs. Two (player vs. player)
- Each joystick controls a corresponding character on the field
- To "KICK" the ball, push the button on top of the joystick when the character controls the ball
- To "SLIDE", push the button on top of the joystick when the character does not have the ball.
- Use the wall(s) to bank kick
- Block opposing players by "body checking" or sliding.



II. VARIOUS OPTIONAL SETTINGS

DESCRIPTIONS OF DIP SWITCHES

- **Dip Switch A**

- **Actual Time of Game (SW1 & SW2)**
(Indicator always shows 3:00 and counts down)

1. 3:00 min.	OFF	OFF
2. 2:30 min.	OFF	ON
3. 2:00 min.	ON	OFF
4. 1:00 min.	ON	ON

- **Game Continuation for 1 Player (SW3)**

Time Extension	SW3
YES	OFF
NO	ON

(The player may play same game with additional credit)

- **Game Continuation for 2 Players (SW4)**

Time Extension	SW4
YES	OFF
NO	ON

(Continuation of a two player game with additional credit)

- **Direction of Screen (SW5)**

Direction	SW5
Normal	OFF
Reverse	ON

- **Dip Switch B (Coin & Credit)**

Coin	Credit	Left-side chute				Right-side chute			
		SW1	SW2	SW3	SW4	SW5	SW6	SW7	SW8
1	1	OFF	OFF	OFF	OFF	OFF	OFF	OFF	OFF
1	2	OFF	OFF	OFF	ON	OFF	OFF	OFF	ON
1	3	OFF	OFF	ON	OFF	OFF	OFF	ON	OFF
1	4	OFF	OFF	ON	ON	OFF	OFF	ON	ON
1	5	OFF	ON	OFF	OFF	OFF	ON	OFF	OFF
1	6	OFF	ON	OFF	ON	OFF	ON	OFF	ON
2	1	OFF	ON	ON	OFF	OFF	ON	ON	OFF
2	3	OFF	ON	ON	ON	OFF	ON	ON	ON
3	1	ON	OFF	OFF	OFF	ON	OFF	OFF	OFF
3	2	ON	OFF	OFF	ON	ON	OFF	OFF	ON
4	1	ON	OFF	ON	OFF	ON	OFF	ON	OFF
1	1	ON	OFF	ON	ON	ON	OFF	ON	ON
1	1	ON	ON	OFF	OFF	ON	ON	OFF	OFF
1	1	ON	ON	OFF	ON	ON	ON	OFF	ON
1	1	ON	ON	ON	OFF	ON	ON	ON	OFF
Free play		ON	ON	ON	ON	ON	ON	ON	ON

- **One Player vs. Computer (SW6)**
(Additional time extended for winning score)

Continuity	SW6
YES	OFF
NO	ON

- **Difficulty of Game (SW7 & SW8)**

Difficulty	SW7	SW8
1. Easy (for beginners)	OFF	OFF
2.	OFF	ON
3.	ON	OFF
4. Hard (for experienced)	ON	ON

- **Factory Settings**

- **Positions of Dip Switches**

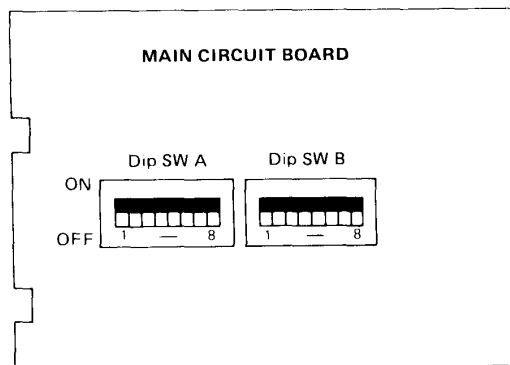

Standard and Custom Price Settings

The game price set by a combination of dip SWs is displayed on the monitor when coin credit is 0.

- When the settings for right and left chutes are the same, "1 coin – 1 credit", "2 coins – 3 credits", etc. are displayed.
- When the settings for right and left chutes are provided differently, their respective contents can be displayed.



(1) INTEGRATED CIRCUITS

Item No.	Qty.	Description
74LS 00	2	
74LS 01	1	
74LS 04	1	
74LS 08	2	
74LS 20	2	
74LS 27	1	
74LS 32	2	
74LS 74	6	
74LS 86	6	
74LS138	3	
74LS139	3	
74LS157	6	
74LS161	3	
74LS244	4	
74LS245	1	
74LS257	4	
74LS273	7	
74LS283	3	
74LS373	1	
74LS374	4	
74LS374	1	
LM324	1	
76489N	1	
NE556	1	
HD465055P	1	
CF 37201	1	
TMS1025N21C	2	
TMS4164-15	16	
Z80A	3	
MB8128-10	1	
MB8128-15	5	
82S147	2	
2764	3	
2764	3	
27128	2	
27256	4	
1001	4	
DIP8P	2	
	1	
7805	1	
	1	
	1	
	1	

(2) CAPACITORS

Rating	Qty	Description
50P	2	
103	4	
104	30	
221	1	
391	3	
47 F25V	1	
10 F16V	2	
470 F16V	2	
20P	2	
28P	10	

(3) CRYSTAL

Rating	Qty.	Description
4.000 MHz	1	
9.828 MHz	1	

(4) RESISTORS

Rating	Qty	Description
47	2	
22	1	
100	1	
200	3	
330	3	
390	3	
470	2	
820	2	
1K	2	
24K	4	
5.1	1	
10	1	
20	1	
51	1	
100	20	
120	4	
3318	4	
1028	2	
1038	2	

This drawing provides standard information.
 Universal reserves the right to change without notice.

UNIVERSAL

IV. SUB-CIRCUIT BOARD IC LOCATION AND PARTS LIST

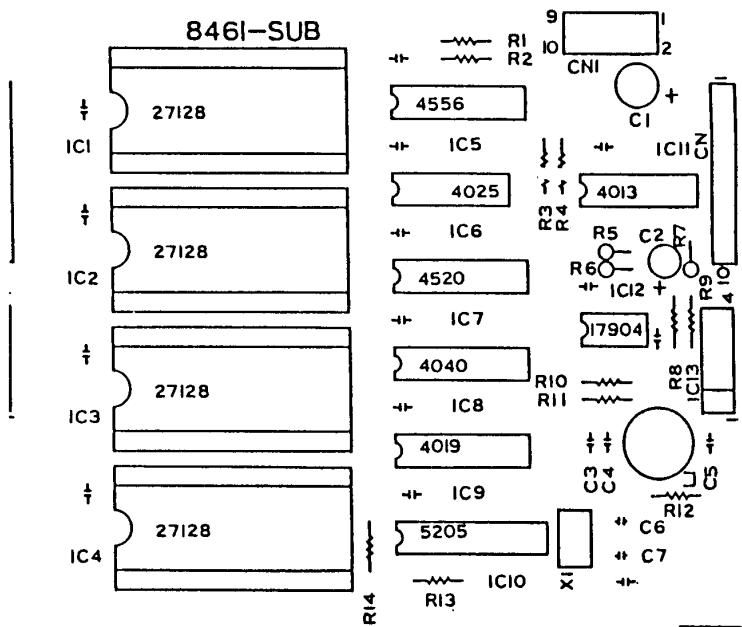

(1) INTEGRATED CIRCUITS

Item No.	Qty	Description
MSM4013	1	
MSM4019	1	
MSM4025	1	
MSM4040	1	
MSM4520	1	
MSM4556	1	
MSM5205	1	
HA17904	1	

(3) RESISTORS

Rating	Qty.	Description
10K	9	
3K	1	
220	1	
1K	1	
47K	1	
470K	1	

(2) CAPACITORS

Rating	Qty	Description
28P	4	
1025	1	

(4) CAPACITORS

Rating	Qty	Description
47 F16V	1	
47 F2.5V	1	
680PF	1	
153	1	
223	1	
100PF	1	
22PF	1	

UNIVERSAL

Fig-1

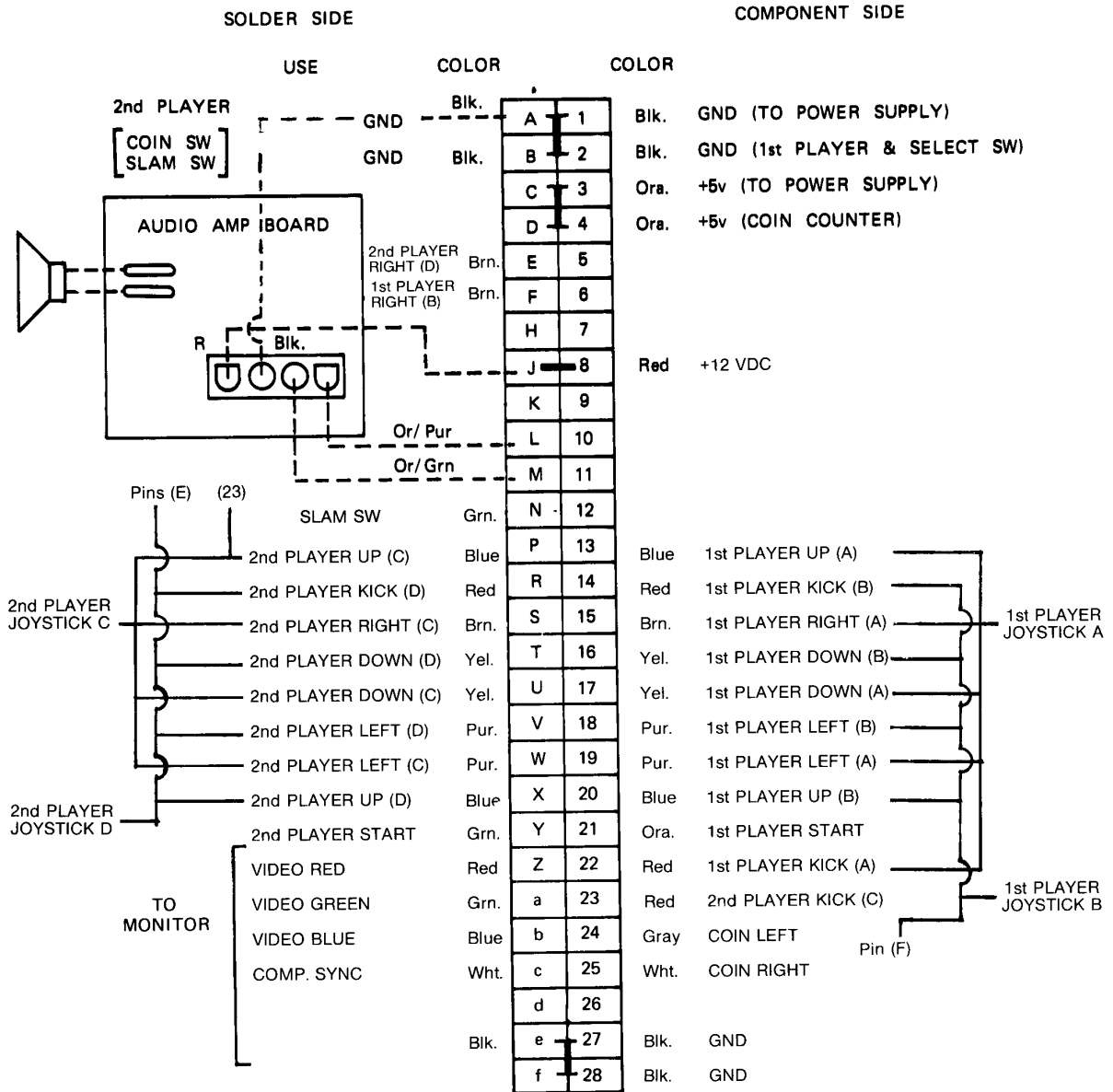

NOTE:

CONNECTION FOR USE WITH COIN METER

CONNECTION FOR USE WITHOUT COIN METER

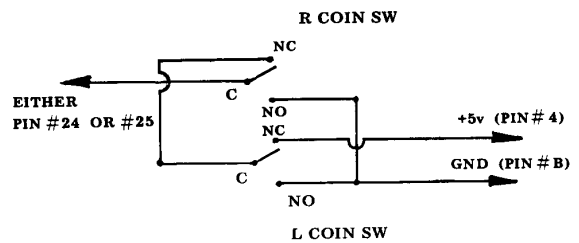
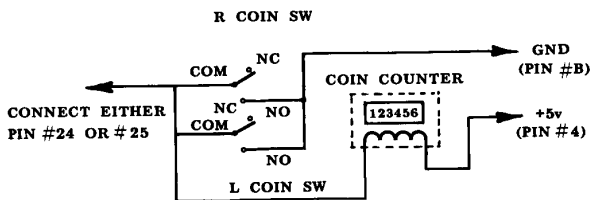

INSTALLATION INSTRUCTIONS

WICO 8-WAY JOYSTICK WITH FIREBUTTON

Wico No. 15-9681-01

Refer to Figures 1 & 2 before starting

1. Unplug the power supply cord to the game.
2. Disconnect the wiring to the original joystick assembly and remove the joystick assembly from the game.
3. Place the 2" washer (furnished with this kit) on top of the new joystick assembly mounting plate directly over the center hole.
4. Mount the replacement joystick assembly to the game.
5. Remove the joystick handle, switch actuator, large compression spring, and E-ring from the bag of parts. Insert the joystick handle through the control panel and joystick assembly. From the inside of the panel, push the spring and switch actuator over the joystick handle shaft and secure with the E-ring.
6. Take the firebutton, small compression spring, firebutton switch actuator and firebutton switch assembly from the bag of parts. Insert the small compression spring over the firebutton shaft. Insert the firebutton and spring through the hole in the top of the joystick handle. From the inside of the panel, press the firebutton switch actuator over the serrations on the end of the firebutton shaft.
7. Take the firebutton switch assembly and clamp it over the joystick switch holder shown in figures 1 & 2.
8. Connect the wiring to the new joystick.
9. Connect the game power supply cord to an outlet.

For replacement parts call

Universal U.S.A., Inc.
1-800-538-7548

or

Wilco Corporation
1-800-323-4258

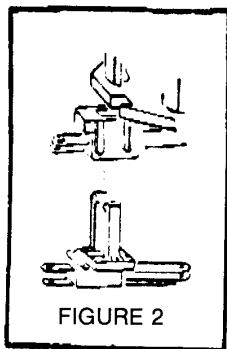

FIGURE 2

"KICK" BUTTON ACTUATOR

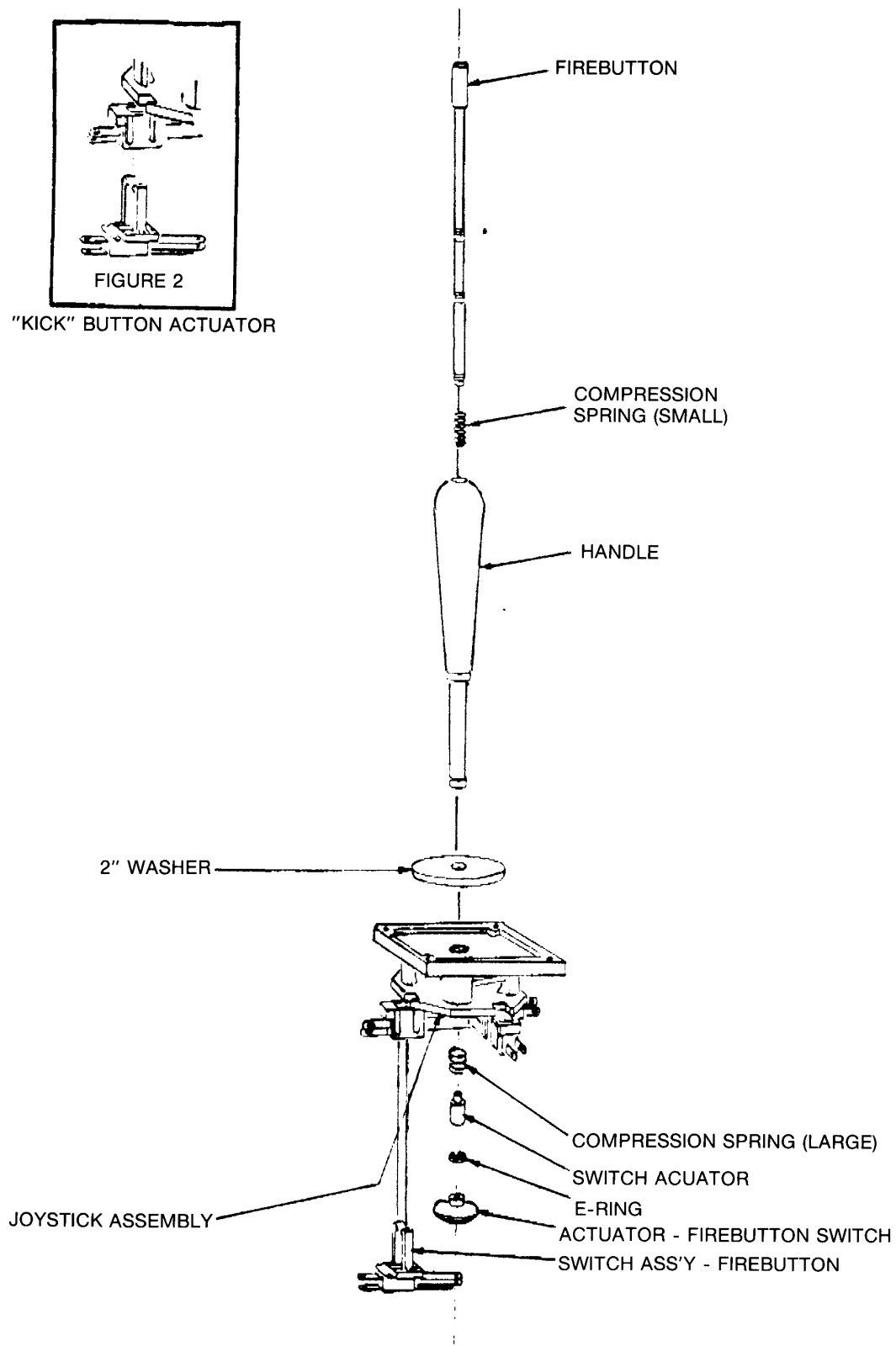

FIGURE 1

INDOOR SOCCER

2 VS. 2

OPERATION PANEL

1. Clear Plex
2. Polycarbonate Overlay
3. Indication Decals
4. 8-Way Joystick (4 each)
5. Buttons (2 each)
6. Pal Nuts (2 each)
7. Button Housings w/Leaf Switch (2 each)

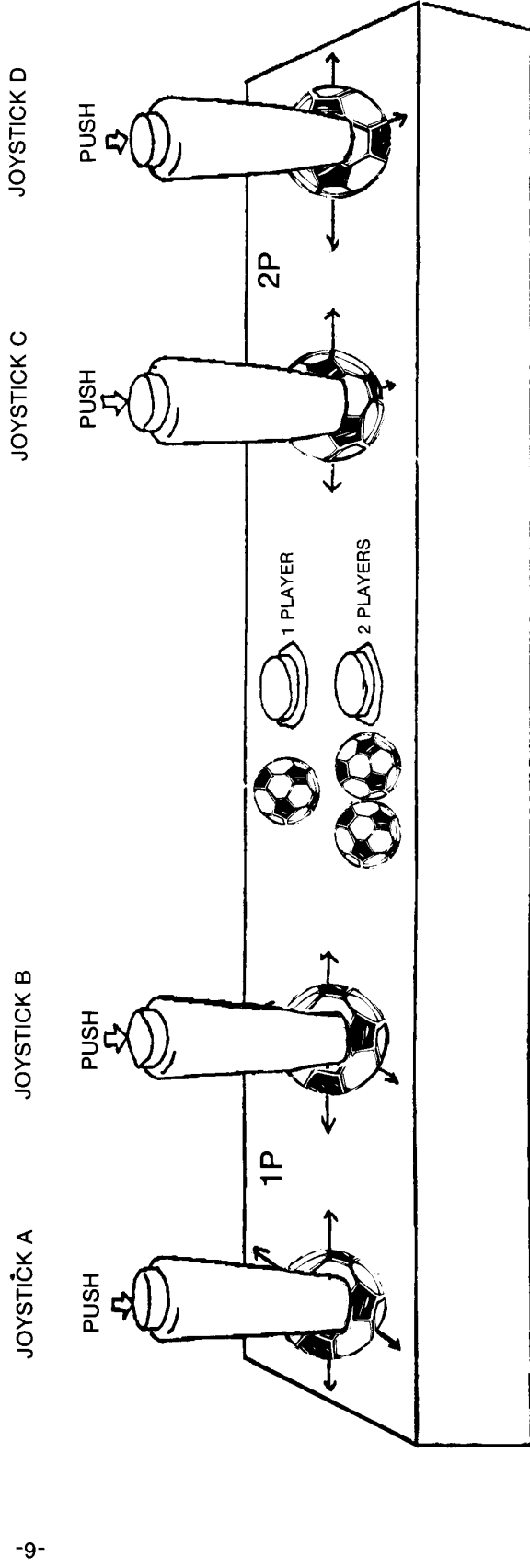

UNIVERSAL

Fig-4

SOUND AMPLIFIER DIAGRAM AND PARTS LOCATION

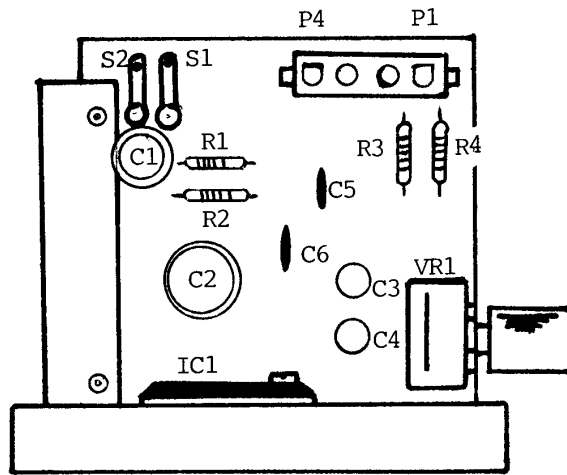
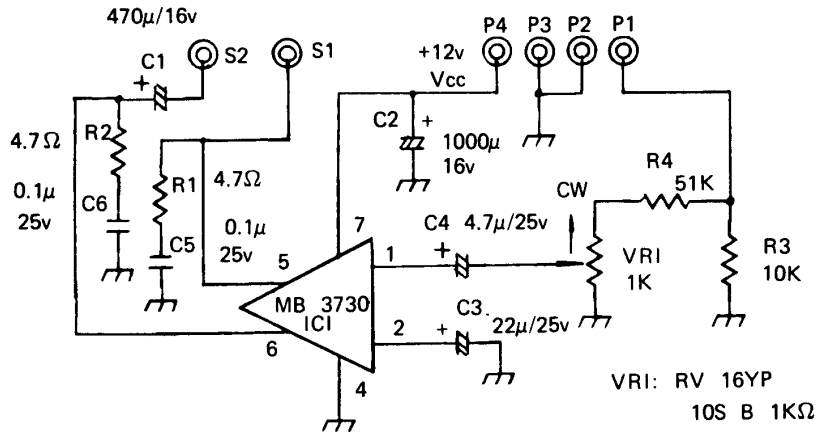

SOUND AMPLIFIER UNIT

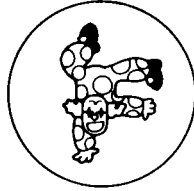

Head Office:

Universal Co., Ltd.

1-7-7, Nihonbashi Horidome-cho, Chuo-ku, Tokyo 103, Japan
Phone: 03-661-6004, 6005 Cable: UNMANIFACT
Telex: J27348 (UNICO)

Universal U.S.A. Inc.

3250 Victor Street, Santa Clara, California 95050, U.S.A.
Phone: 408-727-4591-5 Telex: 172247 (UNI USA SNTA)
Main Line of Business: Development, manufacture, sales, and
exports & imports of amusement machines

European Office

81 Tottenham Court Road, London W1A 1EY
Phone: 01-631-1713 Telex: 892989 ELCOIN