

**CONTRACTS MARKETING**   
**ELECTROHOME ELECTRONICS**

54-7294-02

THIS INFORMATION IS UP TO DATE AS OF MAY 1982

---

**SERVICE AND OPERATION MANUAL**  
**G07 R.G.B. COLOUR MONITOR**  
**13" AND 19" VERSIONS**

# TABLE OF CONTENTS

<b>Description</b>	<b>Page</b>
19" Models .....	3
13" Models .....	4
Service Data Reference .....	5
Warnings .....	5
Operating Instructions .....	6
Performance and Operating Data .....	6
Product Safety and Guidelines .....	7
Service Set-Up Procedure .....	8
Color Service Generator for G07 Monitor .....	10
13" & 19" CRT PCB Component Layouts .....	11
13" & 19" Main PCB Component Layout .....	12
Service Replacement Parts List .....	13 14 15 16
Schematic (13") .....	17
Schematic (19") .....	18

# 19" Model

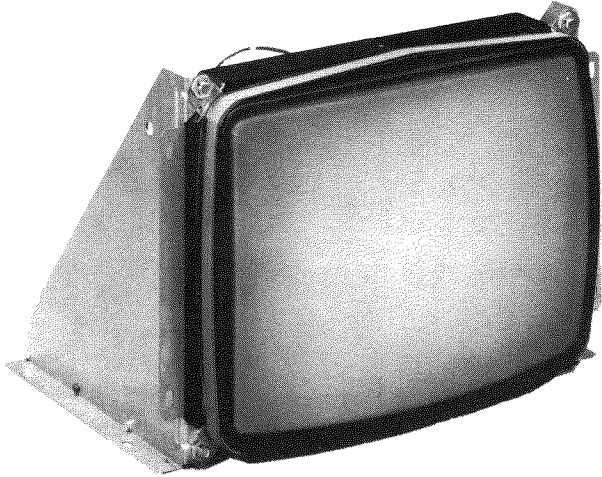

FRONT

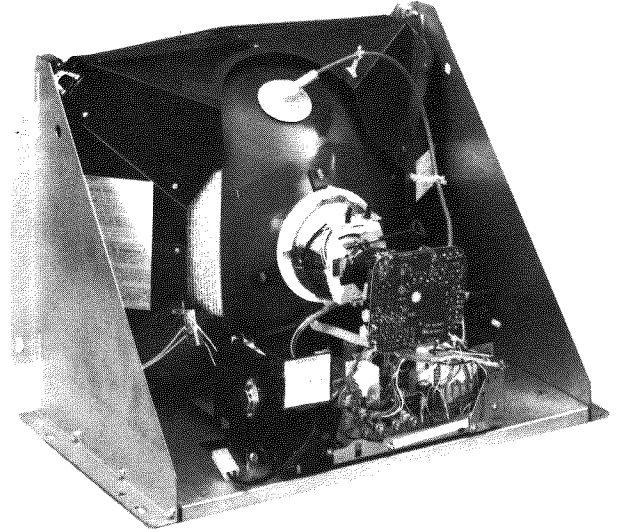

REAR

**G07-904**

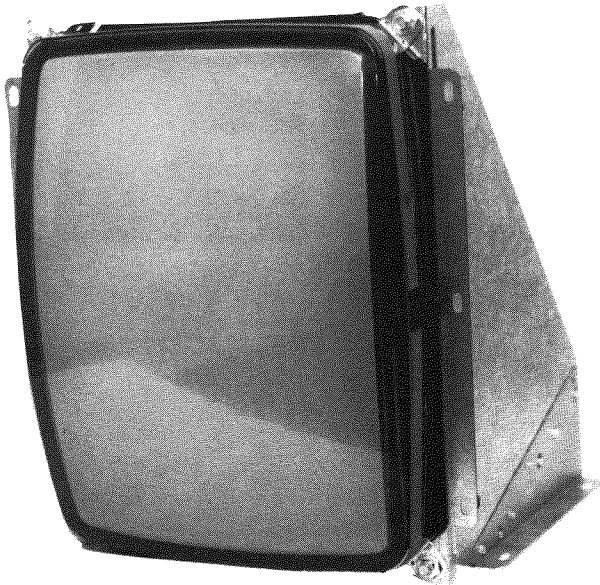

FRONT

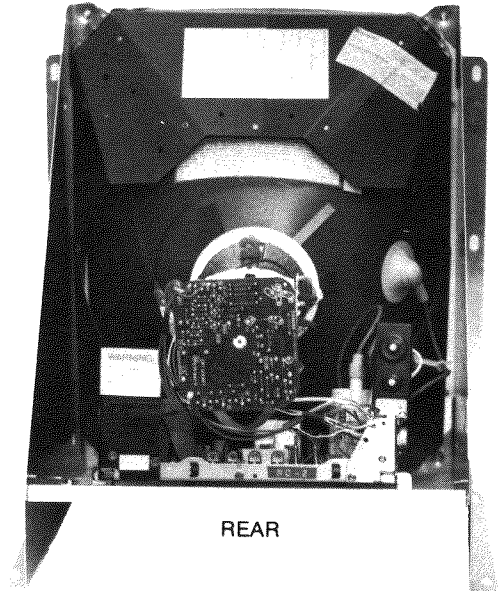

REAR

**G07-907**

# 13" Model

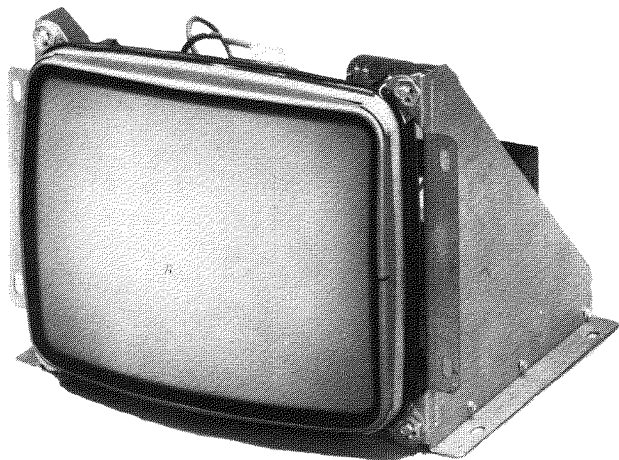

FRONT

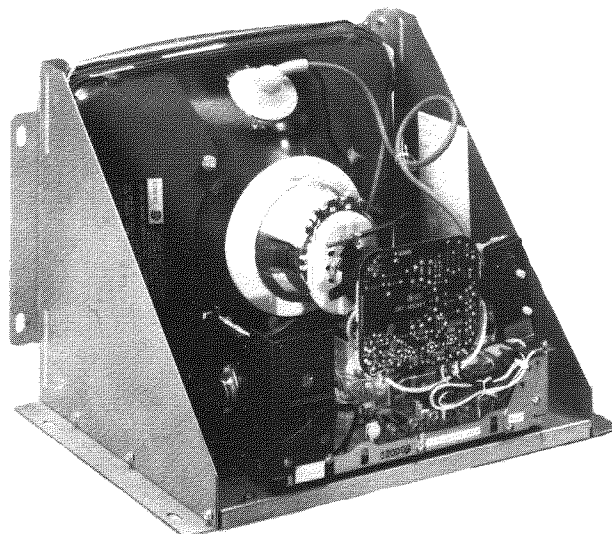

REAR

**G07-902**

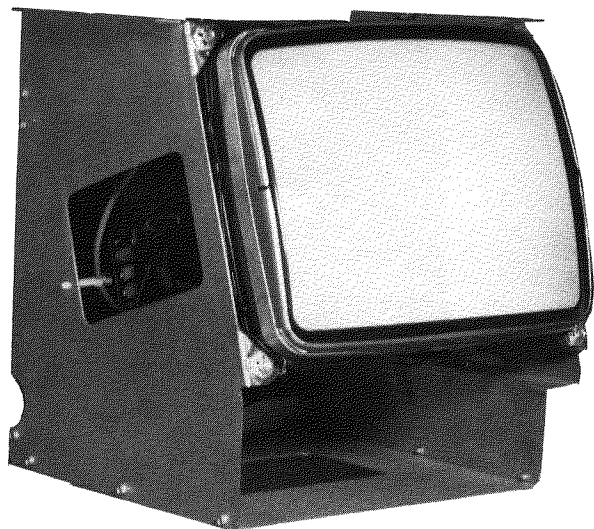

FRONT

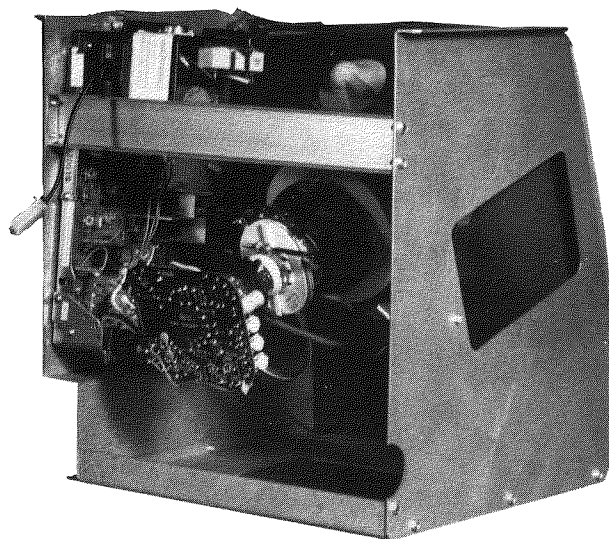

REAR

**G07-906**

## Service Data Reference

When writing for Service Information, please quote chassis type number and model code. See chassis type number and model code located on the right hand side panel. This information is correct as of May, 1982.

**File Supplementary Model Data with this G07 Manual.**

### Warnings

#### 1. Power Up Warning

Caution: If the monitor is to be powered up outside of the games console, an isolation transformer must be used for the AC power source.

#### 2. X-Radiation

This chassis has been designed for minimal x-radiation hazard. However, to avoid possible exposure to soft x-radiation it is IMPERATIVE that the EHT circuitry IS NOT modified.

#### 3. High Voltage



The colour monitor contains HIGH VOLTAGES derived from power supplies capable of delivering LETHAL quantities of energy. To avoid DANGER TO LIFE, do not attempt to service the chassis until all precautions necessary for working on HIGH VOLTAGE equipment have been observed.

#### 4. CRT Handling

The picture tube encloses a high vacuum and due to the large surface area is subject to extreme force. Care must be taken not to bump or scratch the picture tube as this may cause the tube to implode resulting in personal injury and property damage. Shatter-proof goggles must be worn by individuals while handling the CRT or installing it in the monitor. Do not handle the CRT by the neck.

#### 5. To prevent fire or shock hazard DO NOT EXPOSE THIS MONITOR TO RAIN OR MOISTURE.

## Operating Instructions

1. Apply a suitable power source to the monitor through an isolation transformer by means of P901.
2. Apply a suitable signal source to the monitor PCB by mean of J201.
3. For negative input pulses use J202 D2 for vertical  , D3 for Horizontal  .
4. Set up Controls  
All controls are preset at the factory, but may be adjusted to suit program material. Refer to pages 7 and 9 (WHITE BALANCE AND GRAY SCALE TRACKING).

## Performance and Operating Data

### 1.0 Supply

**Min. — Max.**

Voltage 108 VAC - 132 VAC

Frequency 44 Hz - 63 Hz

Note: Apply supply voltage through an isolation transformer with 1 Amp. capability.

### 2.0 High Voltage (EHT)

For 13"V models  
For 19"V models

19.5KV - 22.5KV  
22.5KV - 25.5 KV

Note: Condition for above  $I(\text{beam}) = 0$   
 $B_1 = 120V$

### 3.0 Input Signal and Pin Assignments for J201

Pin No.	Description	Impedance	Signal Range
1	Red input	5K nom.	0 to 4V
2	Green input	5K nom.	0 to 4V
3	Blue input	5K nom.	0 to 4V
4	Ground		
5	Vertical sync pulse	35K nom.	+2V to +4V
6	Horizontal sync pulse	35K nom.	+2V to +4V

### 4. Service Set-Up Controls

- 4.1 B1 adjustment, R909 - Set for  $B_1 = 120V$  DC
- 4.2 Vertical Linearity, R406
- 4.3 Vertical hold control, R422
- 4.4 Horizontal Frequency control, R504
- 4.5 Vertical Hight control, R408
- 4.6 Vertical centering tabs, 3 positions
- 4.7 .Horizontal centering tabs, 3 positions
- 4.8 CRT cut off controls (See fig. 3)
  - Red cut off, R114
  - Green cut off, R115
  - Blue cut off, R113
- 4.9 Video drive controls (See fig. 3)
  - Red drive, R105
  - Green drive, R106
- 4.10 Horizontal width coil, L503
- 4.11 Focus control R11
- 4.12 Screen Control

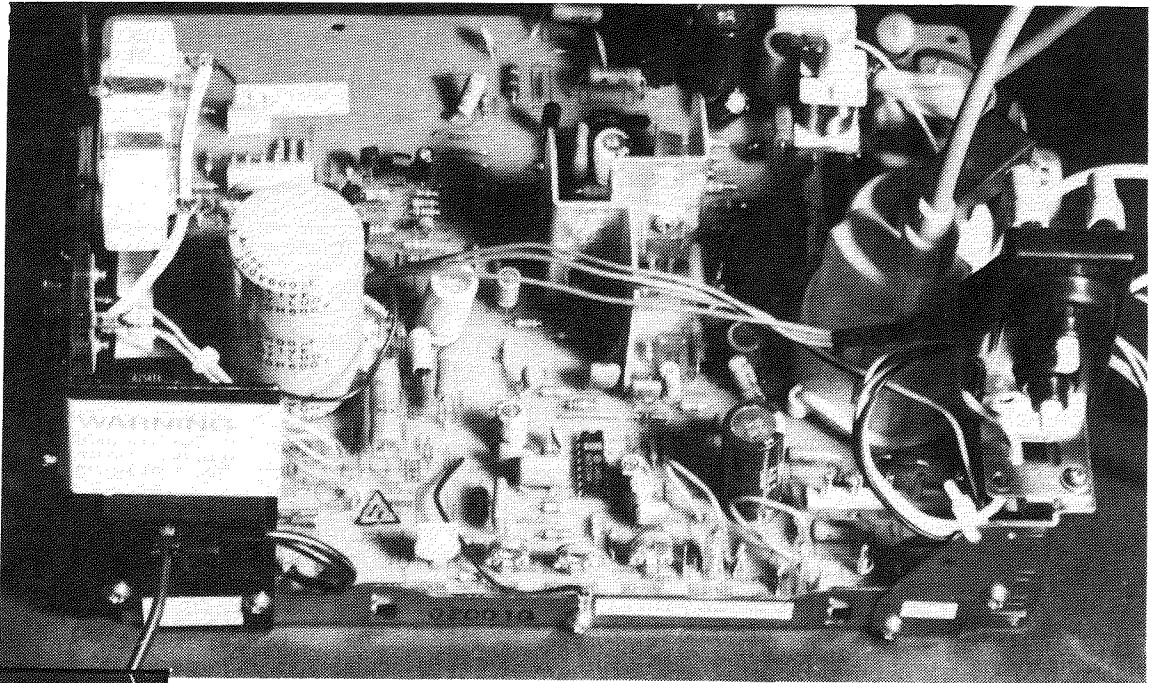

Figure 1

13" and 19" Models

## Product Safety and Servicing Guidelines

### Safety Checks

Subject: Fire and Shock Hazard

1. No modification of any circuit should be attempted. Service work should be performed only after you are thoroughly familiar with all of the following safety checks and service guidelines. To do otherwise increases the risk of potential hazards and injury to the user.
2. When service is required, observe the original lead dress. Extra precaution should be given to assure correct lead dress in the high voltage circuitry area. Where a short circuit has occurred, replace those components that indicate evidence of overheating. Always use the manufacturer's specified replacement component. See parts list in the back of this manual.
3. Periodically check the high voltage for proper value using a meter of known accuracy and calibration.
4. Check for frayed insulation on wires.

### Notes

# Service Set-Up Procedure

NOTE: All monitors are equipped with automatic degaussing coils which effectively demagnetize the picture tube each time the monitor is turned on. The degaussing coils will operate any time the set is turned on after having been off for at least five minutes.

The degaussing effect is confined to the picture tube since the coils are mounted on the ferrous tube shield. Should any part of the chassis or cabinet become magnetized, it will be necessary to degauss the affected area by means of a manual degaussing coil. Move the coil slowly around the CRT face area, then slowly withdraw for a distance of six feet before disconnecting the coil from the AC power supply.

Normally little, if any adjustment should be necessary. However, when a picture tube, yoke or similar component is replaced, preliminary static convergence should be done before attempting purity adjustment, and so on.

Set up should be done in a north/south direction. Horizontal and vertical centering taps should be set to the centre position if a major component has been changed.

## 1.0 Purity

1.1 Loosen yoke retaining clamp (figure 2), remove adhesive material fixing wedges to CRT. Remove wedges completely and clean off dried adhesive from picture tube and wedges.

1.2 A small quantity of "nail polish" has been used to lock the purity convergence rings in place. This seal must be broken with a sharp tipped instrument before any adjustments are attempted. Some models also use a locking ring at either end of the purity and convergence rings. This must be loosened before adjustments are made. It goes without saying that upon completion of all adjustments, the lock must be reset and/or a dab of paint or nail polish must be re-applied to edge of rings to prevent movement.

1.3 Connect an appropriate signal source, eg: Electro-home RGB generator producing a white field plus individual red, green and blue fields.

1.4 Bring the long and short purity tab protrusions in line with each other to obtain near-zero magnetic field (figure 4) (In some cases bring the flat and indented tabs together to obtain zero field). Protrusions can then be vertical, horizontal or at any convenient angle to start.

1.5 Turn off the green and blue fields and adjust setup controls to produce a red field. (See fig. 3)

1.6 Pull the deflection yoke back so that a red band appears in the centre of the screen.

1.7 Spread the tabs apart as little as necessary and rotate both rings together to center the red band horizontally on the face of the CRT (approximate). (See Fig. 5)

1.8 Slide the yoke towards the bell of the picture tube slowly to obtain a uniform red field (pure in color) across the entire tube face. Juggle back and forth slightly as necessary. Lightly tighten yoke retaining clamp.

1.9 Momentarily switch on a cross-hatch signal and rotate yoke to level the pattern on the face of CRT.

1.10 Return generator to regain red raster.

1.11 Turn off red field and check for pure field for each of the green and blue fields. Reposition yoke if necessary to obtain optimum purity on all fields.

1.12 Tighten yoke retaining clamp to prevent yoke shift or rotation. (Do not install wedges at this time.)

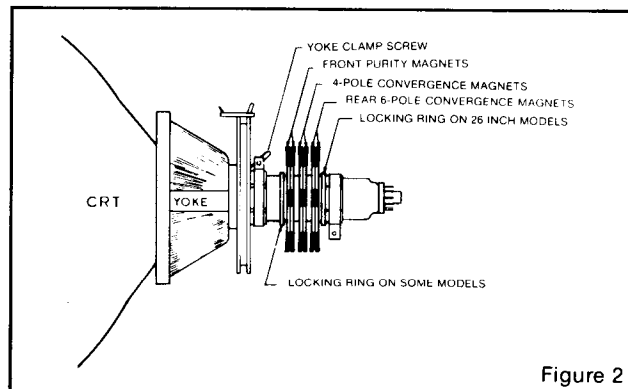

Figure 2

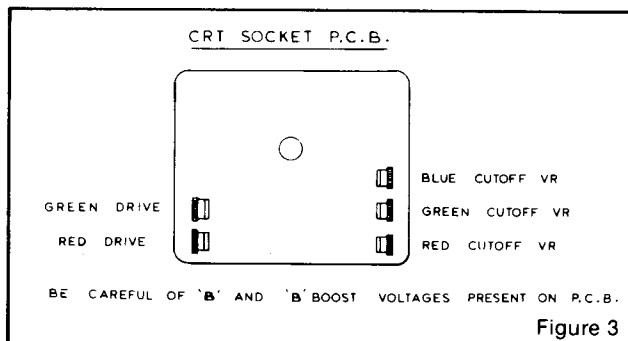

Figure 3

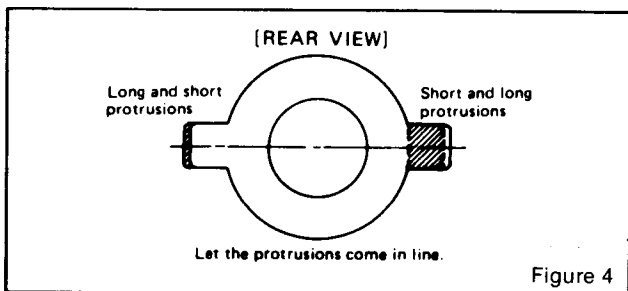

Figure 4

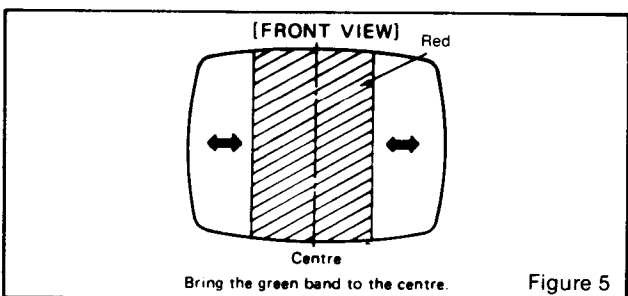

Figure 5



## 2.0 Static and Dynamic Convergence

NOTE: Static convergence is achieved by four magnets located on the neck, nearest the base of the picture tube, Fig. 2. The middle pair of magnetic rings are adjusted to converge the blue and red crosshatch lines. The rear pair of convergence rings (closest to the base of the picture tube) are adjusted to converge the magenta (blue/red) to the green crosshatch lines. Dynamic convergence is achieved by tilting the deflection yoke up-down and left-right.

2.1 Ensure that the controls misadjusted during purity setup (screen, cut-off, etc.) are set to give white balance. See 3.0 below.

2.2 Switch generator to the crosshatch pattern.

2.3 Adjust convergence around the edges of the picture tube by tilting the yoke up-down and left-right, and temporarily install one wedge at the top of the yoke or in a more optimum position. (Figures 8, 9, 10)

2.4 Turn off green input and turn on the red and blue input.

2.5 Rotate the 4-pole (middle) pair of magnets as a unit to minimize separation of the red and blue crosshatch lines around the center of the screen (Figure 6). Variation of the angle between the tabs adjusts convergence of red and blue. (Tilt yoke as required to converge red and blue at the edges as in 2.3 above.)

2.6 Turn on green input to obtain magenta (red/blue) and green crosshatch lines. Rotate the 6-pole (rear) pair of magnets as a unit to minimize separation of the magenta and green lines (figure 7). Vary angle between the two tabs and further rotate as a unit to finalize.

2.7 When convergence of 3 colors is optimized (static in center and dynamic around edges) apply stripe of paint or nail polish to convergence magnet rings to prevent movement. If applicable, tighten locking ring carefully.

2.8 Remove temporary wedge from yoke. Tilt yoke in up-down and left-right direction for best circumference convergence and install 3 wedges. (It is best to use 3 new wedges since they have adhesive backing. Simply pull off tape, slide wedge in place and press outer flap down firmly. For more permanency apply small quantity of silastic or similar material at junction of wedges and picture tube. Do not disturb while material is setting. (Order wedges by part number 39-1233-01).

## 3.0 White Balance (Grey Scale Tracking)

Refer to figure 3. Do the following in subdued light:

3.1 Note this adjustment can be accomplished with no signal connected; eg: input connector open or if a signal generator is connected, switch off all 3 inputs at the generator.

3.2 Set red and green drive controls to their mechanical center and turn the common G2 screen control and 3 cut-off controls to minimum (fully counterclockwise).

3.3 Slowly turn up G2 screen control until the first faint color appears, then back off to edge of visibility. Do not touch the associated cut-off control - it should stay fully CCW for the remaining set-up.

3.4 Slowly turn up the other two color cut-off controls in turn to match the first. This should result in the faintest grey.

3.5 Turn on the signal generator with all 3 inputs on. (a crosshatch pattern would be appropriate).

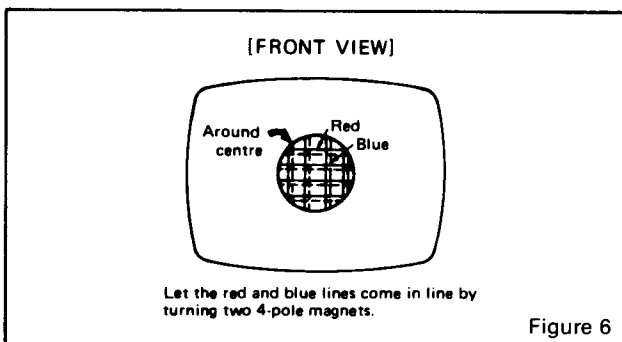

Figure 6

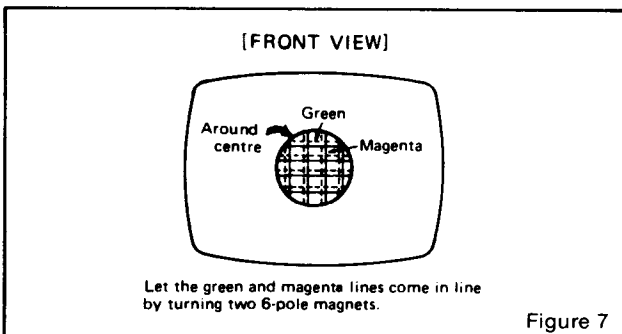

Figure 7

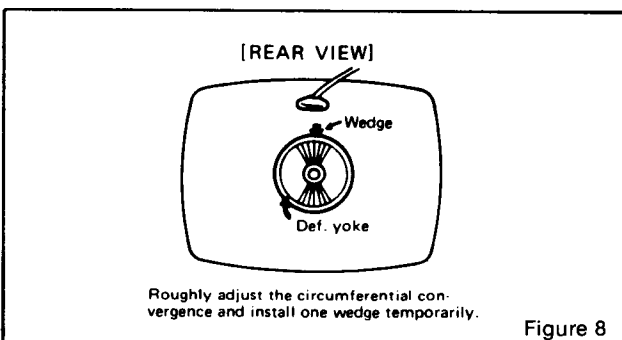

Figure 8

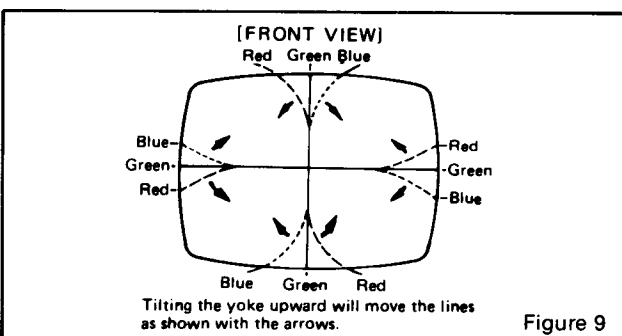

Figure 9

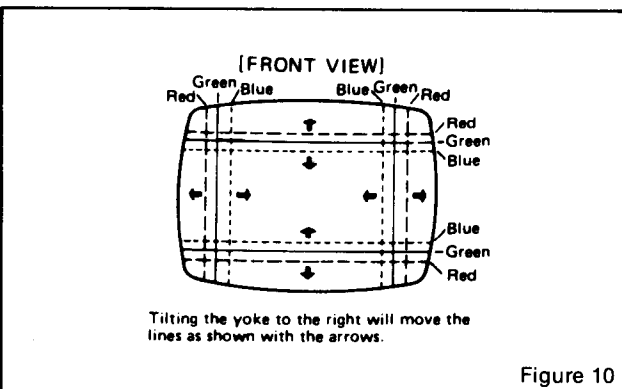

Figure 10

- 3.6 Adjust the red and green drive controls for "neutral white" on high white picture areas. Generally these controls will be left at mech. centre.
- 3.7 Note: When monitor is re-connected with the game the screen control (G2) may require a slight adjustment to obtain proper black level. (the black portion of picture just extinguished).

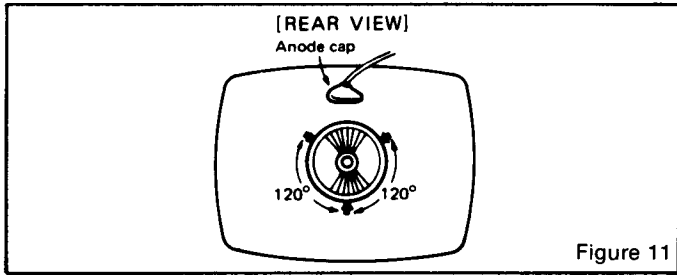

Figure 11

#### 4.0 Power Supply

The regulated +B1 control (R909) has been factory adjusted and normally requires no adjustment. However, if any repairs have been made to the chassis it is recommended that this adjustment should be made.

- Allow 5 minutes to warm up.
- No signal applied.
- Connect an accurate D.C. voltmeter to TP-91 or the emitter of X04 power regulator transistor.
- Adjust R909 for 120V. (See fig. 1)

#### Note:

Should +B1 control be set too high, it may cause possible component damage. Use an accurate D.C. voltmeter to set B1 (B+).

#### 5.0 Focus

Adjust focus control for best overall definition and picture detail an average signal applied. (Highlights should be favoured.)

#### 6.0 Color Service Generator for G07 Monitor

Electrohome has developed a color service generator that is specifically designed for use with the G07 color data monitor. It provides the monitor with both horizontal and vertical sync, as well as the following test patterns:

- Fine cross-hatch pattern
- Broad bar cross-hatch pattern
- Complete field

Three color selection switches, red, green and blue, provide the ability to display the above patterns in the three primary colors as well as the three secondary colors.

This product may be ordered from:

Contracts Marketing  
ELECTROHOME Electronics  
809 Wellington St. North  
Kitchener, Ontario  
Canada N2G 4J6  
Telephone: (519) 744-7111, Ext. 567



#### 7.0 X-Ray Emission Check

- Assure the power supply B1 is properly adjusted to 120V DC. See Item 4.0 (page 8)
- Assure that the anode voltage does not exceed max. as per Item 2.0 page 4.
- Assure that the high voltage hold down circuit is operating correctly. Use the following procedure.
  - Increase the B1 greater than 138.5V by shorting collector/emitter of the power regulator, X04.
  - Observe that the anode voltage (EHT) goes to 0. If the EHT does not go to 0, a fault must be located and repaired.
  - Remove short and set should return to normal operation. (Note, after the short is removed some monitors may not restart. In this case, remove power from monitor momentarily and normal operation will be restored.

#### Note:

The protector circuit consists of the components shown below in Fig. 13 with a circuit description.

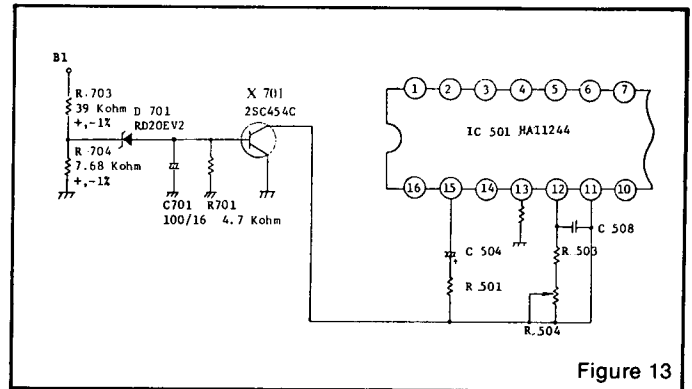

Figure 13

#### 8.0 Circuit Diagram and Description of High Voltage Hold Down or Safety Circuit

- Circuit Diagram of High Voltage Hold Down Circuit.
- Operation of High Voltage Hold Down Circuit.

The high voltage hold-down circuit protects the high voltage circuit from dangerous voltage with short circuiting between emitter and collector of power regulating transistor.

The base voltage of X701 is increased when the B1 voltage is increased more than 138.5 V DC.

When the base of X701 is increased, a short is produced by X701 between pin 11 and ground of IC 501, shutting down the horizontal osc. and high voltage.

# 19" C.R.T. P.C.B. COMPONENT LAYOUT (SU3032A)

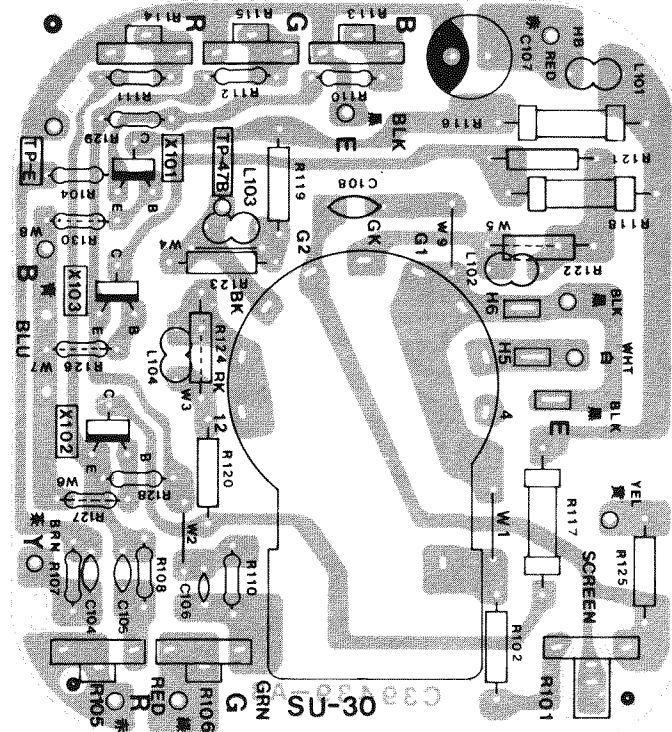

00-18025-06

# 13" C.R.T. P.C.B. COMPONENT LAYOUT (SU3016A)

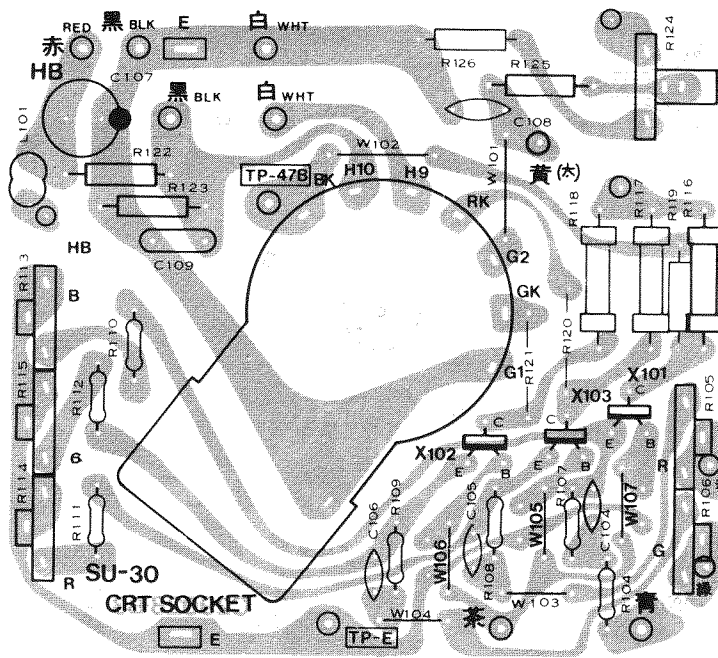

00-18025-04

# 13" & 19" MAIN P.C.B. COMPONENT LAYOUT (SU1103A-13", SU1133A-19")

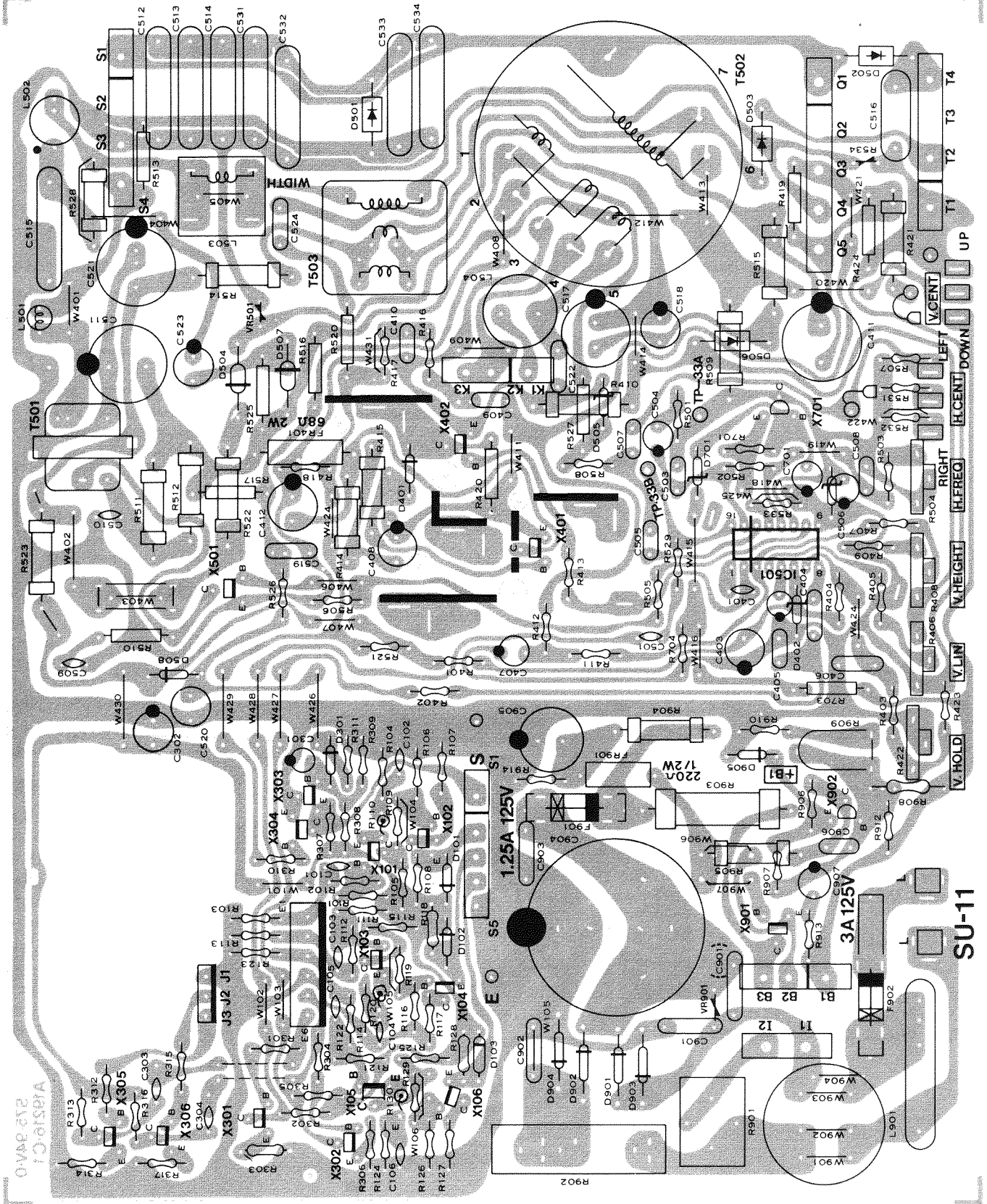

# REPLACEMENT PARTS LIST

## IMPORTANT SAFETY NOTICE

Components identified by the  $\triangle$  symbol on the schematic and parts list have special characteristics for safety. These critical safety components are designed to "fail safe" under abnormal conditions. The failure of any one component often causes stress in other components which could lead to smoke or fire or other hazards. Because of this, components are selected and tested under actual fault conditions to ensure safe operation. Replacement with anything other than the identical Electrohome part may present a hazard.

**ALWAYS ORDER BY PART NUMBER, TO ENSURE FAST DELIVERY AND CORRECT REPLACEMENT**

Note 1: When ordering replacement parts, specify the Model and Chassis Code as well as the Part Description and Part Number.

Note 2:  $\frac{1}{4}$  watt resistors and 50 volt ceramic capacitors are omitted from this parts list. The part number for these parts can be determined if the resistance or capacitance is known as follows:

Resistors: XH- $\square\square\square$ 01 (0- x 1.0)  
(1- x 10)  
Resistance (ohms)  $\square\square\square$  Multiplier (9- x 0.1)

$\square\square\square.\square\square$

XH - 1 2 9 - 0 1  $\longrightarrow$  1.2 ohm  $\frac{1}{4}$ W  
XH - 3 3 3 - 0 1  $\longrightarrow$  33K  $\frac{1}{4}$ W  
XH - 4 7 5 - 0 1  $\longrightarrow$  4.7 Meg  $\frac{1}{4}$ W

Capacitors: XL-C  $\square\square\square$ -02 (0- x 1)  
(1- x 10)  
Capacitance (pF)  $\square\square\square$  Multiplier (7- x .1)

XL-C  $\square\square\square$ -02  
XL-C 6 8 0 -02  $\longrightarrow$  68pF 60V  
XL-C 1 5 3 -02  $\longrightarrow$  .015uF 50V  
XL-C 3 3 7 -02  $\longrightarrow$  3.3pF 50V

# SERVICE REPLACEMENT PARTS LIST

## CHASSIS PARTS

Symbol	Description	Reference Number	Part Number
	Main PCB Assy. - 13"	SU1103A	ZS-1-29
	Main PCB Assy. - 19"	SU1133A	ZS-1-37
	CRT Socket PCB - 13"	SU3016A	ZS-3-12
	CRT Socket PCB - 19"	SU3032A	ZS-3-17
	Purity Shield Assy - 19"	07-220083-03	07-220083-03
V01	CRT - 13"	370ESB22	ZS-7-03
V01	CRT - 19"	17-7198-03	17-19VMNP22
DY01	Deflection Yoke - 13"	C29123-V	ZS-9-11
DY01	Deflection Yoke - 19"	A29779-D	ZS-9-07
	PC Magnet - 13"	A76366-A	ZS-10-04
	PC Magnet - 19"	A75034-B	ZS-10-01
T502	Flyback Transformer - 13"	A19183-A	ZS-65-08
T502	Flyback Transformer - 19"	A29951-B	ZS-65-17
R11	Focus Control - 13"	A46606-A	ZS-85-07
R11	Focus Control - 19"	A46600-A	ZS-85-06
R05	Wirewound Res., 220 $\mu$ 25W	QRF258K-221	ZS-19-03
C04	Ceramic Cap, 150pF 150 VAC	QCZ0101-005	ZS-56-04
X01	Transistor, Horiz. Out - 13"	2SD869	XQ-2SD870
X01	Transistor, Horiz. Out - 19"	2SD870	XQ-2SD870
X02	Transistor, Volt Reg. - 19"	2SC1106	XQ-2SC1106
IC01	IC, Volt Reg. - 13"	STR383	XQ-STR383
L01	Degaussing Coil - 13"	21-1007-31	21-1007-31
L01	Degaussing Coil - 19"	21-1007-30	21-1007-30

## MECHANICAL PARTS

Symbol	Description	Reference Number	Part Number
	PIN Terminal (Degaussing) (2)		34-708-01
	Housing - PIN Terminal (2)		34-709-01
	Ground Strap Assy - 13"		34-697-04
	Ground Strap Assy - 19"		34-574-02
	Ground Strap Wire Terminal		34-228-03

## MECHANICAL PARTS (cont'd)

Symbol	Description	Reference Number	Part Number
	Ground Spring (2) — 13"		35-3560-01
	Ground Spring (1) — 19"		35-212-03
	Screw — CRT Mount (4)		31-631018-08
	Washer — CRT Mount (4)		33-255-01
	Nut Retainer — CRT Mount (4) — 19"		33-494-01
	Bracket — RH — CRT Mount — 13"		35-3919-01
	Bracket — LH — CRT Mount — 13"		35-3919-02
	Bracket — RH — CRT Mount — 19"		35-3890-01
	Bracket — LH — CRT Mount — 19"		35-3890-02
	Clip — PCB Support (2)		33-629-02
	Chassis Base — 13"		38-452-01
	Chassis Base — 19"		38-449-02
	Yoke Wedge (3)		39-1233-01

## MAIN PCB ASSEMBLY (SU1103A-13") ZS-1-29 (SU1133A-19") ZS-1-37

### RESISTORS

Symbol	Description	Reference Number	Part Number
R1406	Trim Pot, 200 $\mu$ Vert Lin	QVZ3230-022	ZS-80-25
R1408	Trim Pot, 200 $\mu$ Vert Height	QVZ3230-022	ZS-80-25
R1410	Metal Film, 6R8 1W 5%	QRX019J-6R8	ZS-94-13
R1414	Metal Oxide, 3K3 1W 5%	QRG019J-332	XH-332-03
R1415	Metal Oxide, 2K7 1W 5%	QRG019J-272	XH-272-03
R1421	Metal Oxide, 12K 2W 5%	QRG029J-123	XH-123-04
R1422	Trim Pot, 10K Vert Hold	QVZ3224-014H	ZS-80-40
$\Delta$ FR1401	Fusible, 68 $\mu$ 2W	QRH024-680M	ZS-41-09
$\Delta$ R1503	Carbon Film, 11K8 1/4W 1%	QRV142F-1182	ZS-116-05
R1504	Trim Pot, 5K Hor. Freq.	QVZ3230-053	ZS-80-12
R1509	Metal Oxide, 10K 2W 5%	QRG029J-103	XH-103-04
R1511 (SU1103A)	Metal Oxide, 5K6 2W 5%	QRG029J-562	ZS-94-15
R1512 (SU1133A)	Metal Oxide, 8K2 2W 5%	QRG026J-822Z	ZS-94-12
R1514 (SU1103A)	Metal Oxide, 680 $\mu$ 2W 5%	QRG019J-681	XH-681-04
R1514 (SU1133A)	Metal Oxide, 820 $\mu$ 2W 5%	QRG019J-821Z	XH-821-04
R1515	Carbon Film, 8R2 1W 5%	QRX019J-8R2	ZS-94-14
R1522	Carbon Film, 4R7 1W 5%	QRX19J-4R7	ZS-141-01
R1523 (SU1103A)	Metal Oxide, 56R 2W 5%	QRG029J-560	ZS-94-16
R1523 (SU1133A)	Metal Oxide, 68R 2W 5%	QRG026J-680Z	ZS-94-17
R1528	Metal Oxide, 390R 1W 5%	QRG019J-391	XH-391-03
R1534	ZNR	ERZ-C05ZK471	ZS-42-04
R1501	ZNR	ERZ-C05DK271	ZS-42-03
$\Delta$ R1703	Carbon Film, 39K 1/2W 1%	QRV122F-3902	ZS-96-01
$\Delta$ R1704	Carbon Film, 7K68 1/4W 1%	QRV142F-7681	ZS-116-07
$\Delta$ R1901	Posistor	A75414	ZS-55-03
R1902	Wirewound, 2R0 7W 10%	QRF076K-2R0	ZS-125-02
R1903	Carbon Film, 5R6 3W 5%	QRX039J-5R6	ZS-94-07
R1903	Carbon Film, 4R7 3W 5%	QRX039J-4R7	ZS-94-03
R1904	Metal Oxide, 10K 2W 5%	QRG026J-103Z	XH-103-04
R1905 (SU1133A)	Metal Oxide, 18K 1W 5%	QRG019J-183	XH-183-03
$\Delta$ R1908 (SU1133A)	Carbon Film, 47K 1/2W 1%	QRV22F-4702	ZS-96-02
R1909 (SU1133A)	Trim Pot, 2K	QVP5A0B-023E	ZS-61-07
$\Delta$ R1910 (SU1133A)	Carbon Trim, 2K74 1/4W 1%	QRV142F-2741	ZS-116-09
$\Delta$ FR1901	Fusible, 220 $\mu$ 1/2W 10%	QRH124K-221M	ZS-41-04

### CAPACITORS

Symbol	Description	Reference Number	Part Number
C1301 (SU1133A)	Bipolar, 3V3 50V	QEN61HA-335Z	ZS-52-10
C1402	Tantalum, 2U2 16V	QEE51CK-225B	ZS-52-09
C1407 (SU1133A)	Electrolytic, 4U7 6.3V	QEW51JA-475	ZS-52-14
C1411	Electrolytic, 100 $\mu$ F 160V	QEW52CA-107	ZS-52-12
C1412	Electrolytic, 3U3 160V	QEW52CA-335	ZS-52-06
C1508	Polypropylene, 5600pF 50V	QFP31HJ-562	ZS-73-02
$\Delta$ C1512, C1513	Polypropylene, 2000pF 1500V	QFZ0082-202	ZS-71-09
$\Delta$ C1514 (SU1103A)	Polypropylene, 2500pF 1500V	QFZ0082-252	ZS-71-18
$\Delta$ C1514 (SU1133A)	Polypropylene, 2000pF 1500V	QFZ0082-202	ZS-71-09
C1515	Polypropylene, 0U53 1200V	QFZ0067-534	ZS-71-03
C1520	Bipolar, 3U3 50V	QEN61HA-335Z	ZS-52-10
C1523 (SU1133A)	Electrolytic, 1 $\mu$ F 200V	QEW62CA-105Z	ZS-52-07
C1524	Mylar, 0.1 $\mu$ F 200V	QFM72DK-104M	ZS-139-07
$\Delta$ C1531 (SU1133A)	Polypropylene, 2000pF 1500V	QFZ0082-202	ZS-71-09
$\Delta$ C1532 (SU1133A)	Polypropylene, 1500pF 1500V	QFZ0082-152	ZS-71-10
C1904	Electrolytic, 600 $\mu$ F 200V	QEY0034-001	ZS-52-02

## MAIN PCB ASSEMBLY (cont'd)

### CAPACITORS (cont'd)

Symbol	Description	Reference Number	Part Number
C1905	Electrolytic, 10 $\mu$ F 250V	QEW52EA-106	ZS-52-04
C1907 (SU1103A)	Met. Mylar, 0.1 $\mu$ F 250V	QFZ9008-104	ZS-140-02

### COILS

Symbol	Description	Reference Number	Part Number
L1501 (SU1103A)	Peaking Coil	A75360-6	ZS-138-05
L1502 (SU1103A)	Linearity	A39934	ZS-77-02
L1502 (SU1133A)	Linearity	A39835	ZS-77-03
L1503	Width	C30380-A	ZS-76-04
L1504 (SU1103A)	Heater Choke	C30333-A	ZS-79-05
L1504 (SU1133A)	Heater Choke	C30445-A	ZS-79-06
L1901 (SU1103A)	Line Filter	A39475-J	ZS-171-03

### TRANSFORMERS

Symbol	Description	Reference Number	Part Number
T1501	Horizontal Drive	A46022-BM	ZS-113-02
T1503	Side Pin	C39049-A/C39050-A	ZS-66-04

### SEMICONDUCTORS

Symbol	Description	Reference Number	Part Number
IC1501	IC, Horiz. and Vertical	HA11244	XQ-HA11244
X1101	Video Amplifier, NPN	2SC1685(R)	XQ-2SC1685
X1102	Video Amplifier, PNP	2SA673(C)	XQ-2SA673
X1103	Video Amplifier, NPN	2SC1685(R)	XQ-SC1685
X1104	Video Amplifier, PNP	2SA673(C)	XQ-2SA673
X1105	Video Amplifier, NPN	2SC1685(R)	XQ-2SC1685
X1106	Video Amplifier, PNP	2SA673(C)	XQ-2SA673
X1301	Sync Amplifier	2SC1685(R)/2SC454	XQ-2SC1685
X1302	Sync Amplifier	2SC1685(R)/2SC454	XQ-2SC1685
X1303	Beam Limiter	2SA673(C)	XQ-2SA673
X1304	Blanking	2SC1685(R)/2SC454	XQ-2SC1685
X1305	Sync Amplifier	2SC1685(R)/2SC454	XQ-2SC1685
X1401	Vertical Output	2SD478/2SD1138	XQ-2SD478
X1402	Vertical Output	2SD478/2SD1138	XQ-2SD478
X1501	Horiz. Drive	2SC2610BK/2SC1507	XQ-2SC2610
X1701 (SU1103A)	X-Ray Protector	2SC1685(P,S)/2SC454C	XQ-2SC1685
X1901 (SU1133A)	Power Driver	2SC688(K,L,M)	XQ-2SC2688
X1902 (SU1133A)	Error Amp	2SC1890A(E,F)	XQ-2SC1890
D1101	Diode	1S2473H	XQ-1S2473
D1102	Diode	1S2473H	XQ-1S2473
D1103	Diode	1S2473H	XQ-1S2473
D1301	Diode	1S2473H	XQ-1S2473
D1401	Diode, Bias	1S2473H	XQ-1S2473
D1402	Zener	RD10F(C)	XQ-RD10FC
D1503	Diode	HF-1/RF-1	XQ-HF1
D1504	Diode	V09E	XQ-V09E
D1505	Zener	RD11E(B)	XQ-RD11EB
D1506	Diode	W06A	XQ-W06A
D1507	Diode	1SS81	XQ-1SS81
D1508	Diode	1S2473H	XQ-1S2473
△D1701	Zener	RD20EV2	XQ-RD20EV2
△D1901	Power Rectifier	1S1887A	XQ-1S1887A
△D1902	Power Rectifier	1S1887A	XQ-1S1887A
△D1903	Power Rectifier	1S1887A	XQ-1S1887A
△D1904	Power Rectifier	1S1887A	XQ-1S1887A
△D1905 (SU1133A)	Zener	RD6.8EV3	XQ-RD68EV3

### FUSES

Symbol	Description	Reference Number	Part Number
△F1901 (SU1103A)	Fuse 1A 250V	QMF53U1-1R05	ZS-120-09
△F1901 (SU1133A)	Fuse 1.25A 250V	QMF53U1-1R25S	ZS-120-12
△F1902	Fuse 3A 250V	QMF66U1-3R0S	ZS-120-05

**CRT SOCKET PCB ASSEMBLY (SU-3016A-13'') ZS-3-12  
(SU-3032A-19'') ZS-3-17**

**RESISTORS**

Symbol	Description	Reference Number	Part Number
R3105	Trim Pot, 200 $\mu$ , R Drive	QVZ3224-022	ZS-80-02
R3106	Trim Pot, 200 $\mu$ , G Drive	QVZ3224-022	ZS-80-02
R3113	Trim Pot, 5K, B Cut-off	QVZ3224-053	ZS-80-04
R3114	Trim Pot, 5K, R Cut-off	QVZ3224-053	ZS-80-04
R3115	Trim Pot, 5K, G Cut-off	QVZ3224-053	ZS-80-04
R3116	Metal Oxide, 10K 2W 5%	QRG029J-103	XH-103-04
R3117	Metal Oxide, 10K 2W 5%	QRG029J-103	XH-103-04
R3118	Metal Oxide, 10K 2W 5%	QRG029J-103	XH-103-04
R3119	Carbon Comp, 3K3 1/2W 5%	QRZ0039-332	ZS-72-03
R3120	Carbon Comp, 3K3 1/2W 5%	QRZ0039-332	ZS-72-03
R3121	Carbon Comp, 3K3 1/2W 5%	QRZ0039-332	ZS-72-03

**CAPACITORS**

Symbol	Description	Reference Number	Part Number
C3107	Electrolytic, 10 $\mu$ F 250V	QEWS2EA-106	ZS-52-04
C3108	Ceramic, 1000pF 1400V	QCZ9001-102M	ZS-56-05

**COILS**

Symbol	Description	Reference Number	Part Number
L3101	Peaking	QQL043K-101	ZS-138-15

**SEMICONDUCTORS**

Symbol	Description	Reference Number	Part Number
X3101 (SU3016A)	Blue Video Output	2SC2611	XQ-2SC1514V
X3101 (SU3032A)	Blue Video Output	2SC1514VC	XQ-2SC1514V
X3102 (SU3016A)	Red Video Output	2SC2611	XQ-2SC1514V
X3102 (SU3032A)	Red Video Output	2SC1514VC	XQ-2SC1514V
X3103 (SU3016A)	Green Video Output	2SC2611	XQ-2SC1514V
X3103 (SU3032A)	Green Video Output	2SC1514VC	XQ-2SC1514V

**MISCELLANEOUS**

Symbol	Description	Reference Number	Part Number
 (SU3016A)	CRT Socket (13'')	A75522	ZS-78-05
 (SU3032A)	CRT Socket (19'')	A76068	ZS-78-06





EN BLUE X101, X103 and X105 VIDEO AMP, 2SC454C or 2SC1685  
 X102, X104 and X106 VIDEO AMP, 2SA673C

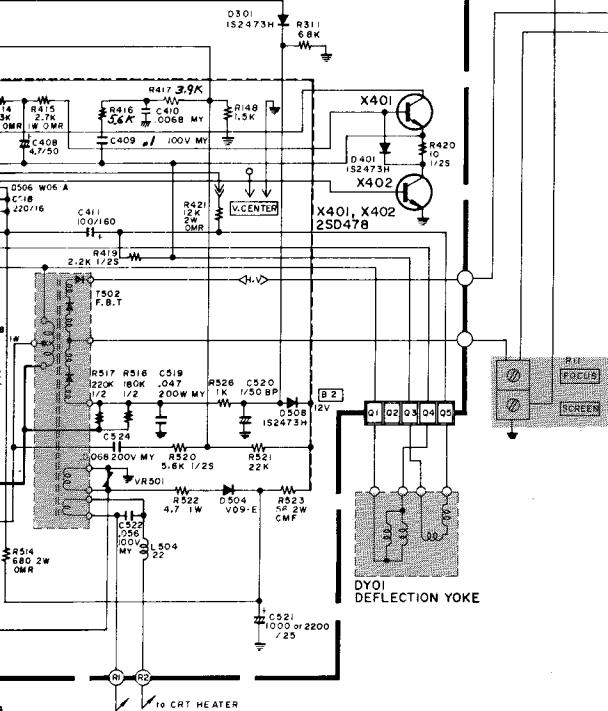
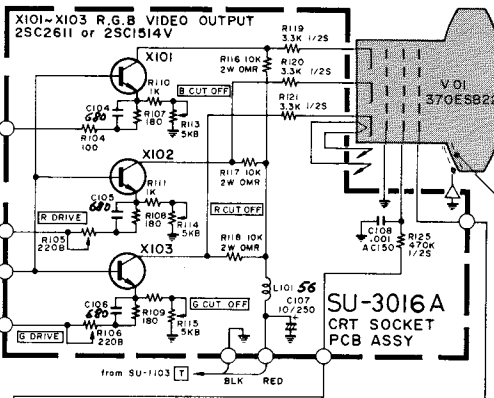
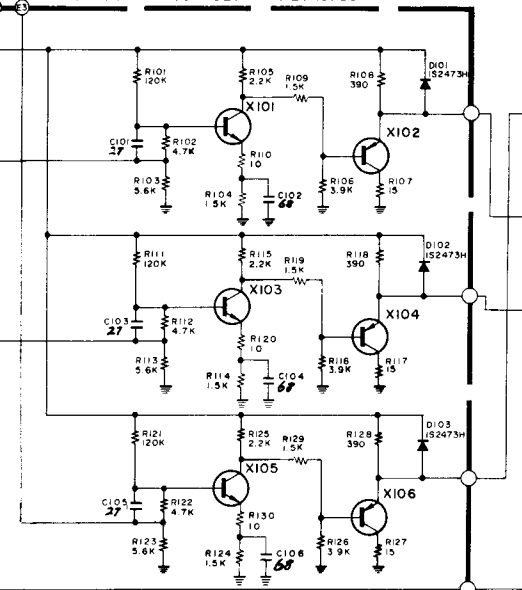

**Schematic Notes**

Unless otherwise specified

Resistance: ( $\Omega$ ) (K $\rightarrow$ K $\Omega$ , M $\rightarrow$ M $\Omega$ ), 1/4 (W) carbon resistor

Capacitance: 1 or higher  $\rightarrow$  (pF), less than 1  $\rightarrow$  ( $\mu$ F)

working voltage  $\rightarrow$  50 (V)

ceramic capacitor

Inductance: ( $\mu$ H)

Electrolytic Cap: Capacitance Value ( $\mu$ F)/working voltage (V),

NP  $\rightarrow$  non-polar (or bipolar) electrolytic cap.

Refer to the parts list for additional component information.

$\oplus$  indicates test point connection

$\perp$  indicates chassis ground unless otherwise specified

Hz indicates cycles per second

For safety purposes (and continuing reliability)

$\triangle$  replace all components marked with safety symbol with identical type.

NOTE: FR  $\rightarrow$  fusible resistor ( $\rightarrow$  ~~FR~~)

13"

G07-FBO  
 00-4147-03

Parts identification on circuit boards:

e.g. SU1126A (R107 = R1107)

SU3030A (R113 = R3113)

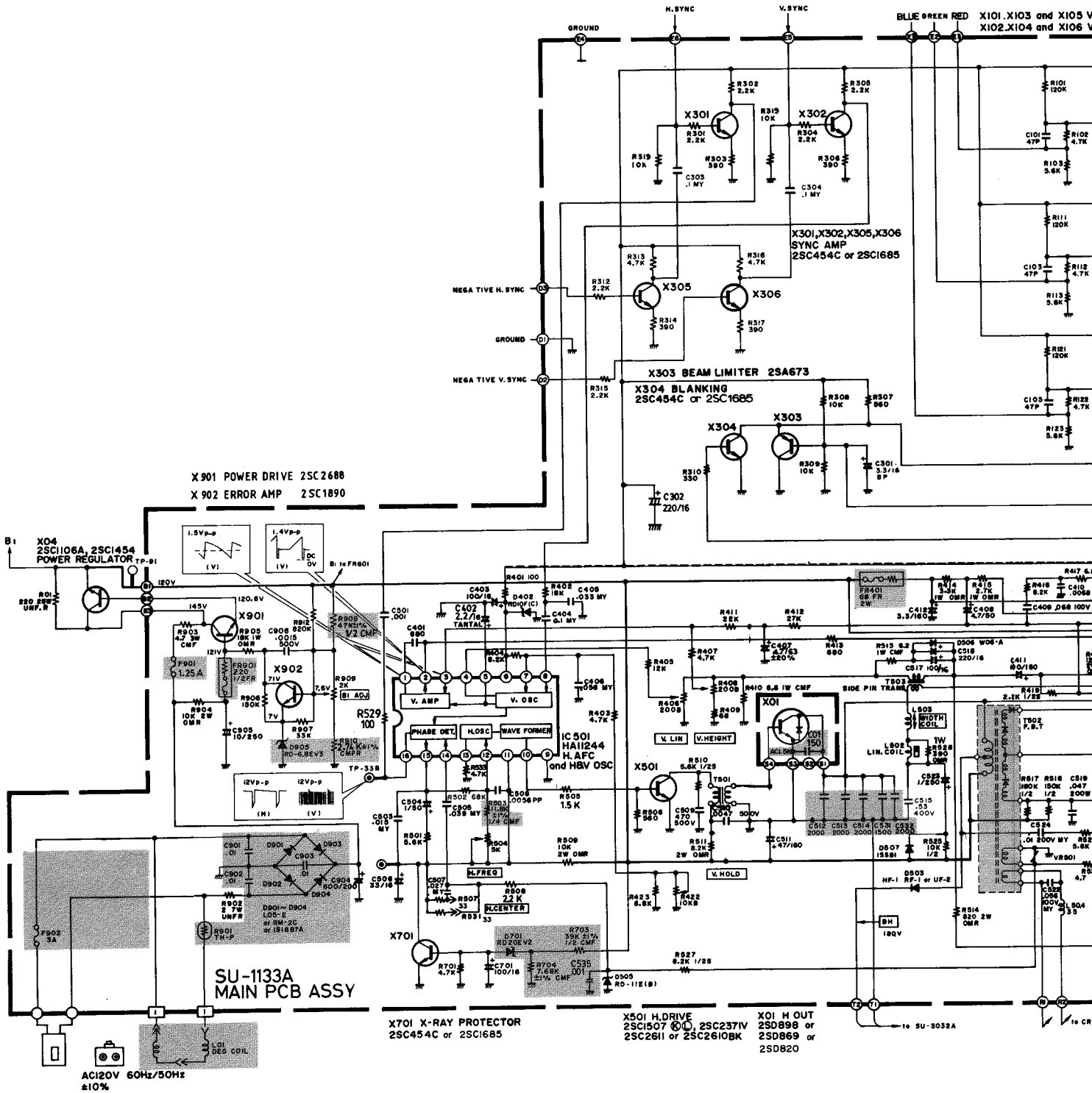

01 X103 and X105 VIDEO AMP 2SC454C  
 02 X104 and X106 VIDEO AMP 2SA673C

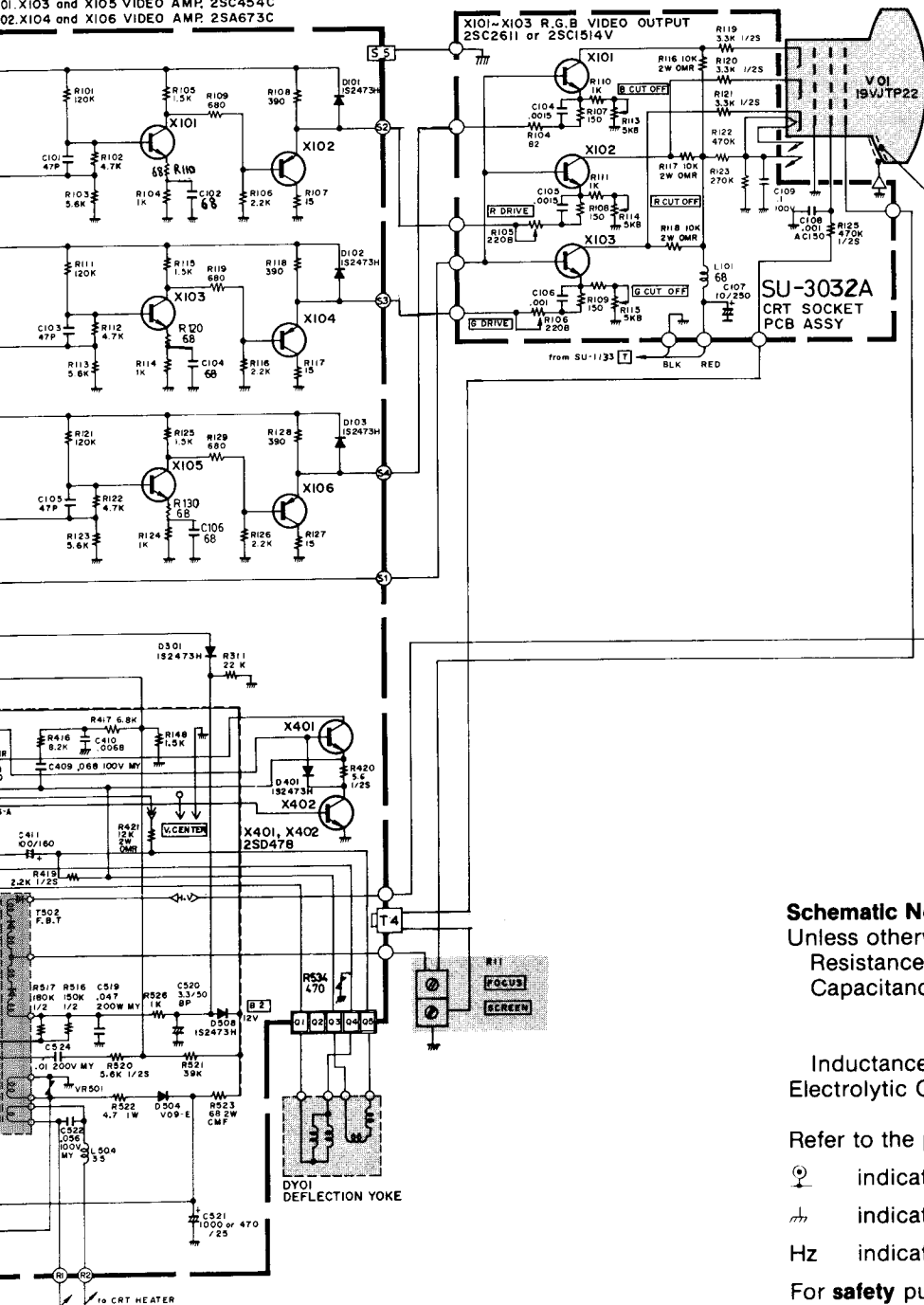

**Schematic Notes**

Unless otherwise specified

Resistance: ( $\Omega$ ) (K $\rightarrow$ K $\Omega$ , M $\rightarrow$ M $\Omega$ ), 1/4 (W) carbon resistor

Capacitance: 1 or higher  $\rightarrow$  (pF), less than 1  $\rightarrow$  ( $\mu$ F)

working voltage  $\rightarrow$  50 (V)

ceramic capacitor

Inductance: ( $\mu$ H)

Electrolytic Cap: Capacitance Value ( $\mu$ F)/working voltage (V),  
 NP  $\rightarrow$  non-polar (or bipolar) electrolytic cap.

Refer to the parts list for additional component information.

$\odot$  indicates test point connection

$\perp$  indicates chassis ground unless otherwise specified

Hz indicates cycles per second

For **safety** purposes (and continuing reliability)

$\triangle$  replace all components marked with safety symbol with identical type.

NOTE: FR  $\rightarrow$  fusible resistor

19"

00-4147-04  
 G07-CB0

Parts identification on circuit boards:

e.g. SU1126A (R107 = R1107)

SU3030A (R113 = R3113)

## **PARTS AND SERVICE LOCATIONS**

### **USA**

**ELECTROHOME (USA) Limited**  
250 Wales Avenue,  
Tonawanda, New York 14150  
Telephone: 1-716-694-3332  
Telex:

### **CANADA**

**AABEX Electronic Services**  
145 Idema Road,  
Markham, Ontario  
Canada L3R 1A9  
Telephone: 1-416-475-0313  
Telex: 06-986-819

**AABEX Electronic Services**  
3444 Lougheed Highway,  
Vancouver, British Columbia  
Canada V5M 2A5  
Telephone: 1-604-253-8421  
Telex: 045-1486

**Service Electrohome**  
370 Isabey St.  
Ville St-Laurent, Quebec  
Canada H4T 1W1  
Telephone: 1-514-731-2736  
Telex: 058-26588

**Service Electrohome**  
809 Wellington St. N.,  
Kitchener, Ontario  
Canada N2G 4J6  
Telephone: 1-519-579-7600

### **INTERNATIONAL**

**Service Electrohome**  
809 Wellington St. N.,  
Kitchener, Ontario  
Canada N2G 4J6  
Telephone: 1-519-744-7111, Ext. 441, 442, 443  
Telex: 069-55320