

CONTRACTS MARKETING 

ELECTROHOME ELECTRONICS

54-7291-01 Issue 3

THIS INFORMATION IS UP TO DATE AS OF MAY 1982.

---

**INSTRUCTION AND SERVICE MANUAL**

**G05-802/805 MONOCHROME**

**“QUADRASCAN”**

**X-Y MONITOR**

---

ELECTROHOME LIMITED, KITCHENER, ONTARIO, CANADA N2G 4J6 PHONE 519-744-7111

TM-151

ZZ-729101-03  
Video Display Monitor 1982 -3

# TABLE OF CONTENTS

Description	Page No.
X-ray, High Voltage and CRT Warnings .....	Inside Front Cover
Product Safety Servicing Guidelines .....	2
Operating Instruction .....	2
Monitor Explosion View .....	16, 17
Deflection Amp Assembly Drawing .....	15
EHT Supply PCB Assembly Drawing .....	15
Performance Data .....	3
EHT Limit Verification Procedure .....	3
Circuit Description .....	3, 4
Waveforms .....	7, 8
Service Information .....	5, 6
Deflection Amplifier PCB Layout — Component Side .....	11
EHT PCB Layout — Component Side .....	13
Schematic — Deflection/Power/Z Amp .....	10
Schematic — EHT Supply .....	12
Service Replacement Parts List .....	17, 24
Service Branch Locations .....	Back Cover

## WARNINGS

### 1. X Radiation

This chassis has been designed for minimal x-radiation hazard. However, to avoid possible exposure to soft x-radiation it is **IMPERATIVE** that the EHT circuitry **IS NOT** modified.

### 2. HIGH VOLTAGE

This monitor contains HIGH VOLTAGES derived from power supplies capable of delivering LETHAL quantities of energy. To avoid DANGER TO LIFE, do not attempt to service the chassis until all precautions necessary for working on HIGH VOLTAGE equipment have been observed. In order to prevent damage to solid state devices, do not arc pix tube anode lead to chassis or earth ground.

### 3. CRT Handling

The picture tube encloses a high vacuum and due to the large surface area is subject to extreme force. Care must be taken not to bump or scratch the picture tube as this may cause the tube to implode resulting in personal injury and property damage. Shatter-proof goggles must always be worn by individuals while handling the CRT or installing it in the monitor. Do not handle the CRT by the neck.

4. To prevent fire or shock hazard DO NOT EXPOSE THIS MONITOR TO RAIN OR MOISTURE.

5. FILE SUPPLEMENTARY MODEL DATA WITH THIS G05 MANUAL.

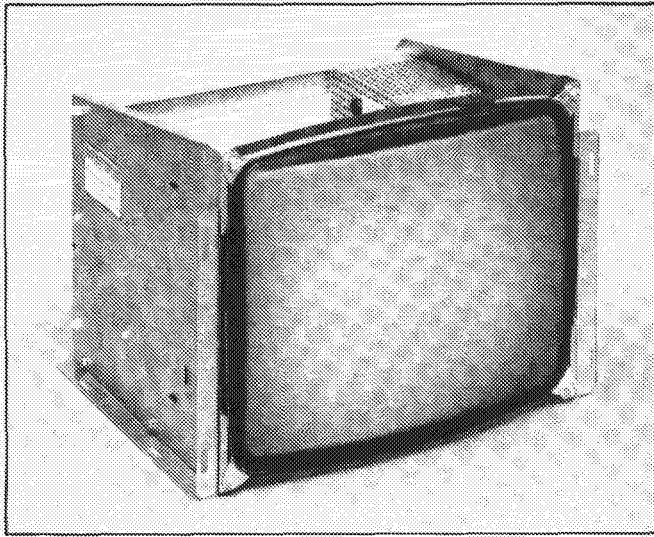

**G05-805 (15")**

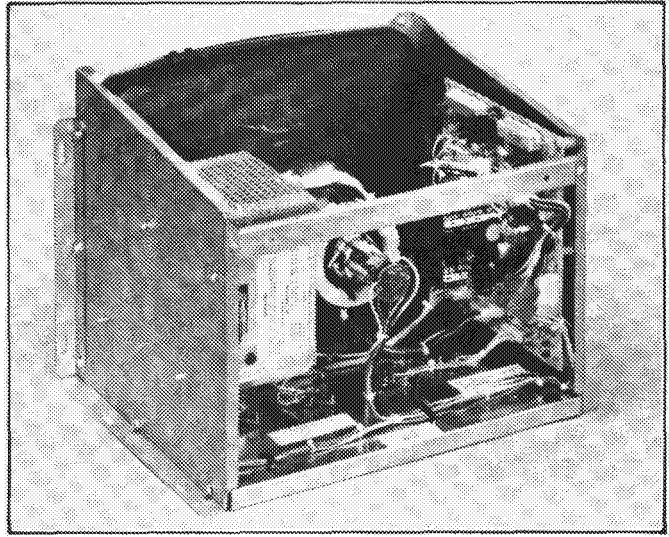

**G05-805 (15")**

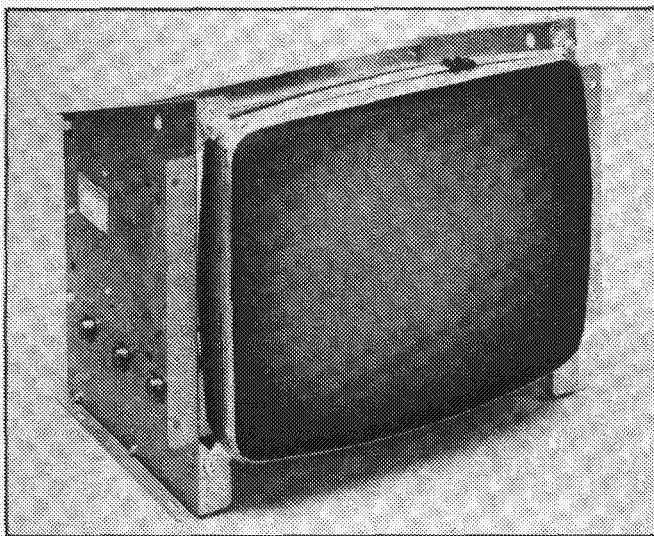

**G05-802 (19")**

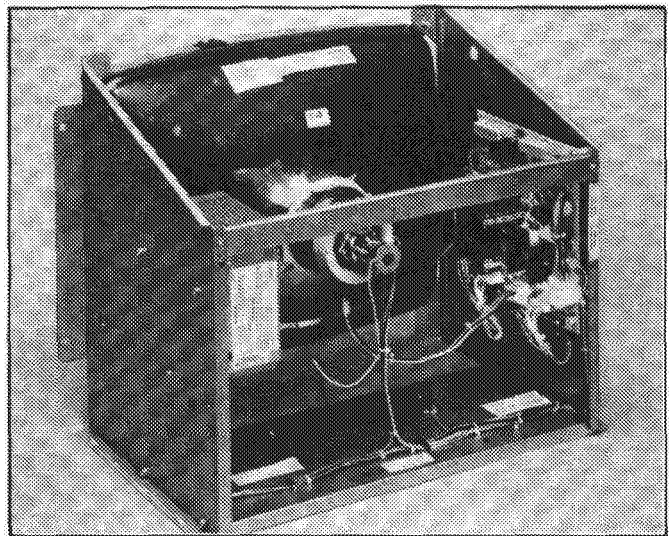

**G05-802 (19")**

# PRODUCT SAFETY SERVICING GUIDELINES

## CAUTION

No modification of any circuit should be attempted. Service work should be performed only after you are thoroughly familiar with all of the following safety checks and servicing guidelines. To do otherwise increases the risk of potential hazards and injury to the user.

## SAFETY CHECKS

### Subject: Fire and Shock Hazard

1. Do not install, remove, or handle the picture tube in any manner unless shatter-proof goggles are worn. People not so equipped should be kept away while picture tubes are handled. Keep the picture tube away from the body while handling.
2. When service is required, observe the original lead dress. Extra precaution should be given to assure correct lead dress in the high voltage circuitry area. Where a short circuit has occurred, replace those components that indicate evidence of overheating. Always use the manufacturer's specified replacement component. See parts list in the back of this manual.
3. Periodically check the high voltage for proper value (12. KV at O beam current) using a meter of known accuracy and calibration.
4. Check for frayed insulation on wires.
5. If service is performed on the EHT Module, the EHT overvoltage Limit circuit MUST BE VERIFIED AS OPERATING AT 18.5 KV MAXIMUM.

## OPERATING INSTRUCTIONS

1. Apply a suitable power and signal source to the monitor regulator PCB by means of P100.
2. **Brightness and Contrast**  
These controls are preset at the factory, but may be adjusted to suit program material. They are located on the right hand edge of the deflection amplifier PCB. R517 is the brightness control and R514 is the contrast control. Both are finger adjustment controls.

**Caution must be exercised when adjusting the brightness control. This control has more than 100% brightness range on most tubes. This control should be maintained below the point where a center spot appears on the CRT under a no input signal condition. Adjusting the control above this point may result in a phosphor burn.**

4. **Spot Killer Indicator**  
A spot killer circuit is used to blank the CRT under a no signal condition. When the spot killer is active, the CRT will be extinguished and LED D504 will light indicating spot killer operation.
5. **Power Down**  
The signals that drive the X-Y monitor must be removed before the monitor is powered down. This sequence must be followed or a phosphor burn may result. This damage is permanent and cannot be repaired.

## PERFORMANCE DATA

### INPUT AND ADJUSTMENT DATA

#### 1. Supply Voltage

A.C. power must be applied to the monitor through plug P100 from the isolated secondary winding of a power transformer, capable of supplying the following voltages at line frequencies from 47 to 63 Hz.

Model G05-802 (19")

Model G05-805 (15")

Main Winding: 30-0-30 VAC RMS + 10-15% at 2 amps maximum.

Filament Winding: 6.3 VAC  $\pm$  10% at .45 amps.

Pin Assignment of P100:

<u>Pin No.</u>	<u>Description</u>
1	Z input .5V blanking 1.0V black level 4.0 V full on 220 ohm impedance
2	Y input $\pm$ 7.5V 1K impedance
3	X input $\pm$ 10V 1K impedance
4	Power GND (CT.)
5	Y signal GND
6	X signal GND
7	30 VAC RMS
8	Z signal GND
9	6.3V AC heater input
10	30 VAC RMS
11	Power GND (CT.)
12	Heater GND

#### 2. High Voltage (EHT)

12.0 KV at zero beam current.

#### 3. Customer Controls

- Brightness Control: Located on deflection amp printed circuit board. Control is finger adjustable.
- Contrast Control: Located on deflection amp printed circuit board. Control is finger adjustable.

#### 4. Service Controls — These are factory preset and should only be adjusted by trained personnel.

- High Voltage Adjust: Located in EHT supply module. Hole in screen cover provides access to this control.  
**Caution — Use insulated tool to adjust.**
- Linearity Controls: R700 and R702 are linearity controls for "X" channel. R600 and R602 are linearity controls for "Y" channel. These controls are located on the deflection amplifier printed circuit board.
- Focus Control: Located in EHT supply module. Hole in supply heat sink/wrap provides access to this control.

## MAXIMUM HIGH VOLTAGE TEST

\*If the EHT module requires servicing this test must be performed.

Remove signals to X, Y and Z channels. This can be done by unplugging Pins No. 1, 3, 5 in harness coming from P100. Insert a 20 KV FSD EHT meter on the CR7 anode.

Power up the monitor and adjust the line voltage until the AC input to the bridge rectifier DB100 is 66 VAC CT instead of the nominal 60 volts. Turn brightness control to minimum.

While observing the EHT meter, short the regulator transistor Q900 Collector to Emitter with a screw driver and note the maximum high voltage obtained. This voltage must be less than 18.5 KV. A voltage reading over this value indicates an out of tolerance high voltage module and this condition must be corrected before the module is put back into active service.

## CIRCUIT DESCRIPTION

### HV MODULE

The high voltage module has been designed to operate over an input supply voltage range of 31 to 42 volts and an ambient temperature range of 0 to 55° C. The module produces nominal voltages of:

- 12 KV at 200 ua
- 400 volts G2 voltage
- 0 to 400 volts focus
- 90 volts for Z amplifier

The circuit can be broken down into two basic sub-systems, the regulator and high voltage generator.

## **REGULATOR**

This is a series regulator with Q900 being the control element. Since any change in high voltage will be reflected back to the 90 volt line, these variations are sensed, amplified and used to control the series pass transistor which then supplies more or less voltage as may be needed to maintain a relatively stable CRT anode voltage. The primary function of R900 is to limit the high voltage generated under a regulator failure condition. It also serves to limit dissipation in Q900. The high voltage supply is fused by F102, a 1A slow blow fuse, located on the deflection PCB. The high voltage supply is isolated from the main ripple component of the primary filters by D100 and C900.

## **HIGH VOLTAGE GENERATOR**

The high voltage generator is a free running Hartley oscillator that operates at approximately 30 KHz. The oscillator transistor is Q903. The voltage made available from the pass transistor is stepped up by means of T900 and rectified to produce 12 KV anode voltage. One other tapped winding produces operating voltages for G2 and focus electrodes of the CRT, and Z amplifier. All of the secondary diodes are of the fast recovery type to operate efficiently at the 30 KHz oscillator frequency.

## **DEFLECTION PCB**

### **Z AMPLIFIER**

Transistor Q504 forms a common emitter amplifier. A TTL compatible brightness signal is applied by means of P100-5. An amplified and inverted replica is present at the collector and this is applied to the CRT cathode. AC gain (contrast) is controlled by R514 and fixed resistor R513. Transistor Q503 is normally biased on very hard by means of R511, R512 and may be treated as a low value resistor that plays no significant part in active amplification of the signal.

Brightness is controlled by varying the DC potential at G1 of the CRT, by means of R517. Diode D506 and C504 isolate and hold the cathode voltage high during power down to prevent phosphor burn. At the same time as the 90 volt line is decaying, the bias for Q503 is lowered, turning the transistor off and further retarding discharge of C504.

### **SPOT KILLER**

The deflection signal is sampled for rate of change and amplitude on both channels, by means of R500, R501, C500, C501 and then rectified to form a negative holding voltage on C502, C503. This negative voltage holds Q500 and Q501 off. There is no current flow through Q502 and LED D504 is not lit. When the sampled signal falls below minimum requirement then the positive voltage applied by R506, R507 turns on Q500, Q501. This causes Q502 to conduct, allowing the LED to illuminate and apply sufficient positive voltage to the emitter of Q503 to cut the transistor off, thereby blanking the display.

### **POWER SUPPLY**

A 60 V CT voltage is applied by means of P100-7, 8, 9, 10. These lines are fused by F100, F101 and applied to bridge rectifier DB100. The resulting DC is roughly filtered by means of C100 and C101 and then applied to the circuitry. R100 and R101 serve to limit inrush current to the filters and offer some protection to DB100 in case of a fault condition. Typical operating voltages are  $\pm 34$  VDC.

The DC voltage to the high voltage supply is taken off before the current limiting resistors and is separately fused by F102. The EHT supply voltage is isolated from the main filter ripple component by D100. With the EHT supply functional, a normal operating voltage at P500-10 would be + 40 V.

### **DEFLECTION AMPLIFIER**

Both X and Y channels are identical. Because of this we will investigate only Y channel operation. There are minor resistor value changes in R704, R604 to accommodate the 19" and 15" CRTs of the G05-802 and G05-805 models. The amplifier is a direct coupled voltage to current converter. The small signal response of the amplifier is approximately 1 MHz. Large signal slew rate for full deflection is approximately 150 usec.

The input signal is pre-distorted by the components located within the input bridge comprised of D600, D601, D602, D603, to compensate for inherent CRT non linearity in deflection. Controls R600 and R602 are used to set size and linearity. The gain corrected signal is applied to the base of the input differential amplifier whose constant current source is formed by Q604, Q606, D607 and R611. The reference diodes are also shared by a second constant current source Q607.

The amplified signal is applied to a cascode stage formed by Q605, Q606 and then applied to the bases of output transistors Q608, Q609. These transistors are operated class B in an emitter follower configuration. Current is coupled through F600 to the yoke and then to ground through the sense resistor R620. Very heavy feedback is applied from R620 to the base of Q603, to correct for any non linearities in the amplifier. A considerable amount of power supply ripple can be tolerated because of the push pull arrangement of output transistors, and the cancelling effect of such a stage on any common ripple component. R621 serves as a critical yoke damping resistor.

## SERVICE INFORMATION

### DEFLECTION AMPLIFIER

This board is held in place by 2 mounting screws and 2 retaining clips. There is sufficient slack in the harness so that service may be performed with the set operating and this board removed from its mounting position. All of the plugs are keyed so improper termination would be difficult.

The linearity controls R700, R702 X channel, and R600, R602 Y channel are factory sealed and do not normally require adjustment. If adjustment is necessary the seals must be broken and a generator capable of displaying a diagonal crosshatch pattern on the monitor must be used. Adjustment, while not impossible, would be difficult on a conventional crosshatch pattern. The nominal input of  $\pm 10$  and  $\pm 7.5$  volts must be used. Both linearity controls interact. They must be adjusted for best overall linearity with a displayed pattern size of  $11\frac{1}{4} \times 15$  inches for G05-802 and  $8\frac{7}{8} \times 11\frac{1}{4}$  inches for G05-805. Before adjustment is undertaken, EHT should be verified as being 12 KV 0 beam. Should the sense resistors R720, R620 need replacement, they must be replaced only with resistors of the same value or monitor performance will be degraded.

Both output channels are fused. The fuses must be replaced with similar fuses for continued protection.

**Caution: Removal of any plug on the deflection board other than input plug P100 on an operating monitor could result in phosphor burn.**

### EHT MODULE

The CRT anode voltage is adjustable by means of R905. This control is accessible through the top perforated shield of the module. A small flat blade screwdriver of non metallic composition should be used for this adjustment. The EHT is adjustable from approximately 10 KV to 14 KV at 0 beam current. Nominal EHT is 12.0 KV at 0 beam current.

Focusing may be set by means of R909. This control is accessible through the side shield of the module. It is a flat blade screwdriver adjustment. The focus voltage is adjustable over the range of 0 to 400 volts. Focus should be set for best overall definition.

The fuse for the EHT supply is located on the Deflection PCB. This fuse must be replaced only with a slow blow device of equivalent rating.

When replacing the EHT module, make certain that the CRT anode is safely discharged to ground before removing the anode cap. Make certain the ground wire coming from the rear of the module is re-attached before operating EHT module in the monitor. This ground wire prevents damage to the oscillator transistor in the event of internal arcing in the CRT.

Typical input current from the 40 V line for a normally operating unloaded EHT module is .3 amps. Input current will increase with loading and higher than 12 KV EHT.

Under a load of 200 ua the EHT should not change by more than 300 volts from 12 KV.

A suitable load can be made from 6, 10 M ohm 1W resistors in series. Caution must be used when doing this check.

The 90V line should be capable of supplying 25 ma output current with good regulation. A suitable load would be a 3k9 ohm 2W resistor momentarily held on to the 90V terminal. The output voltage should not drop by more than 5 volts.

The focus and G2 voltages are capable of only very low current drain; they are potential voltages only.

### CRT REPLACEMENT

**Caution: CRT anode should be discharged to aquadag ground strap before attempting replacement. All precautions regarding CRT handling should be observed.**

Remove CRT socket, yoke and anode lead. The CRT may then be removed by loosening the four front panel mounting screws. It will be necessary to verify centering, geometry and linearity. Adjustment may be necessary.

### CENTERING ADJUSTMENT

In a semi-dark area with no signal input, brightness control at minimum (maximum CCW rotation), and the yoke unplugged, apply power to the set and after thirty seconds warm up time carefully advance the brightness control until a just visible spot appears on the CRT. Adjust this spot to the geometric center of the CRT by means of the centering rings. Reduce the brightness control to minimum and switch off the set. Plug in the yoke.

## GEOMETRY ADJUSTMENT

Before adjusting the geometry verify that the EHT is 12 KV. Set the signal generator to display a rectangle of  $10\frac{1}{2}'' \times 14''$  on G05-802 and  $10\frac{1}{2}'' \times 7\frac{7}{8}''$  on G05-805. Adjust the brightness control for comfortable viewing of the display, keeping below the point where a no signal center spot appears on the CRT. Correct any yoke tilt and tighten the yoke clamp. Check that maximum geometry distortion falls within the guidelines as described in the following diagram. Geometry distortion is corrected by proper positioning of magnets on the yoke housing.

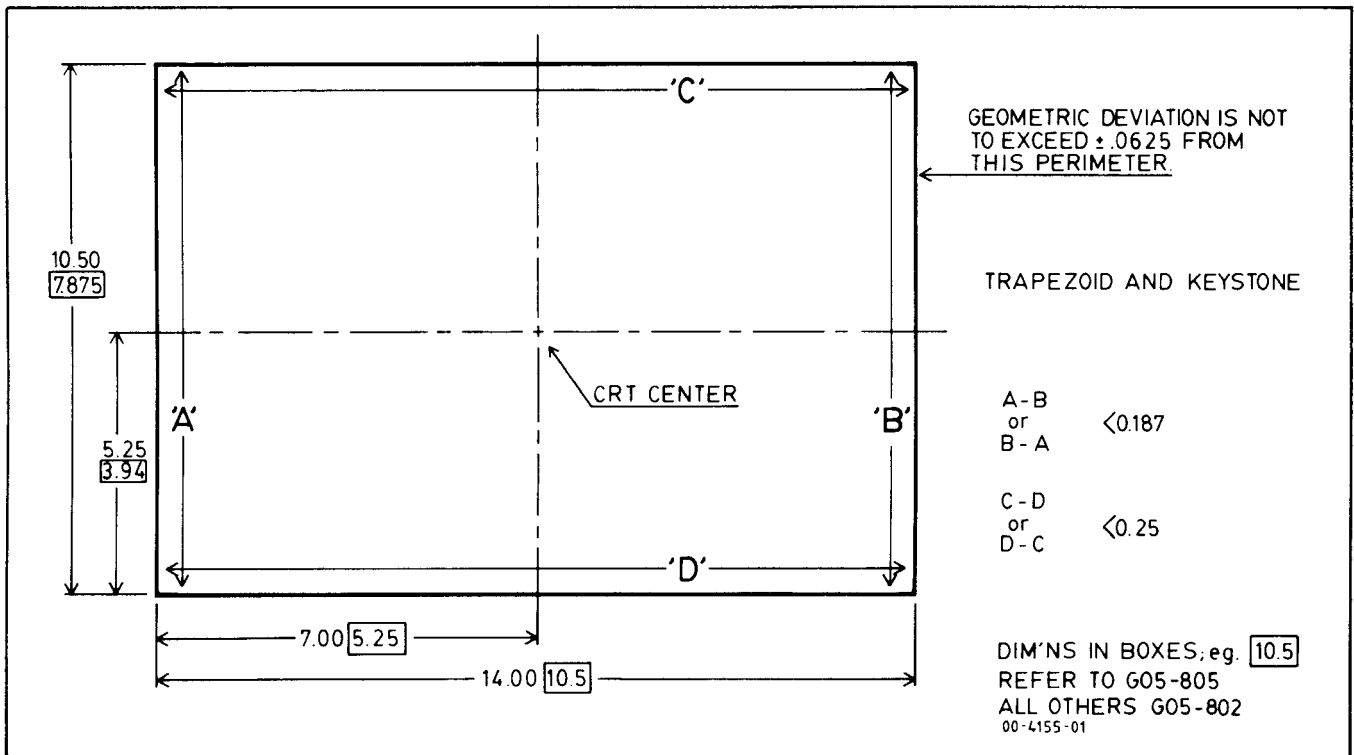



# WAVEFORMS

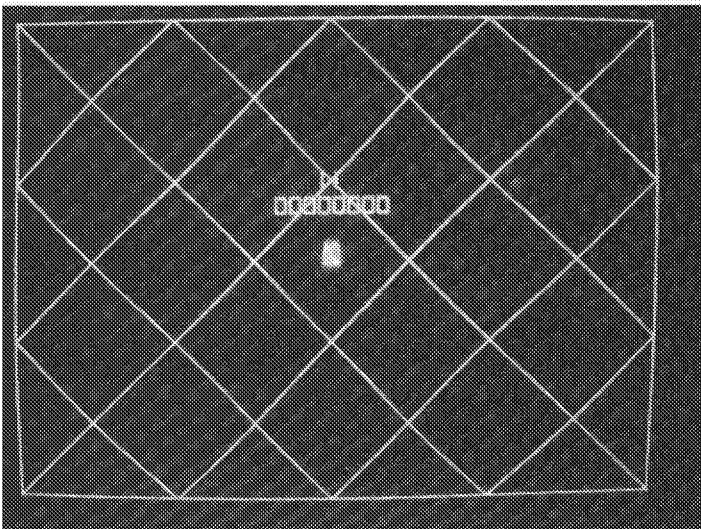

Signal Generator  
Test Pattern  
As Displayed on Monitor

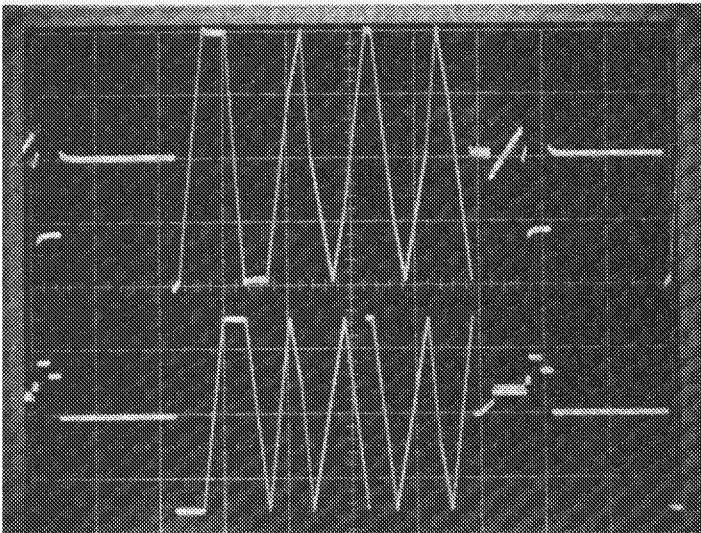

SIGNAL GENERATOR

DC "0" 5 v/cm V X CHANNEL  
2 ms/cm H INPUT

DC "0" 5 v/cm V Y CHANNEL  
2 ms/cm H INPUT

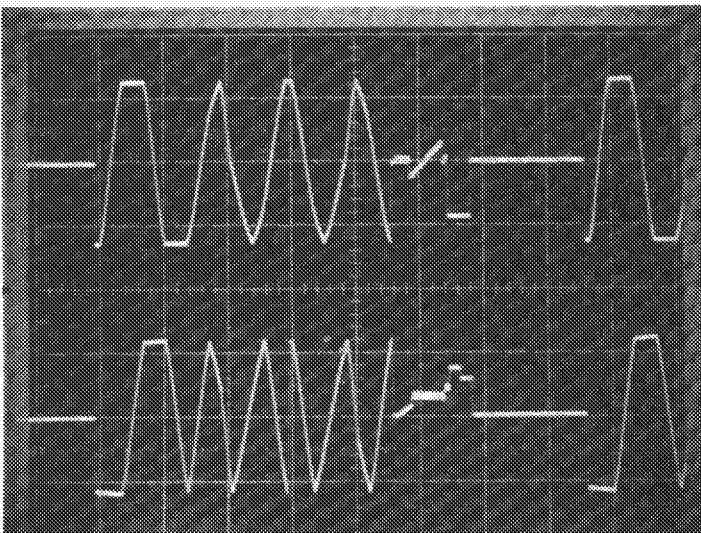

X-Y AMPLIFIER

DC "0" 2 v/cm V X CHANNEL  
2 ms/cm H Measured Across  
R720

DC "0" 2 v/cm V Y CHANNEL  
2 ms/cm H Measured Across  
R620

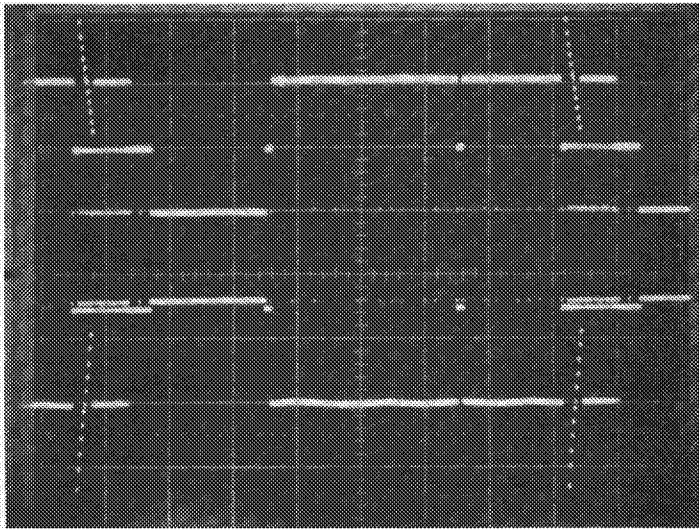

Z AMPLIFIER  
 INPUT SIGNAL  
 "0" DC 1 v/cm V  
 2 ms/cm H

COLLECTOR OF  
 Q504  
 +70 VDC 10 v/cm V  
 2 ms/cm H

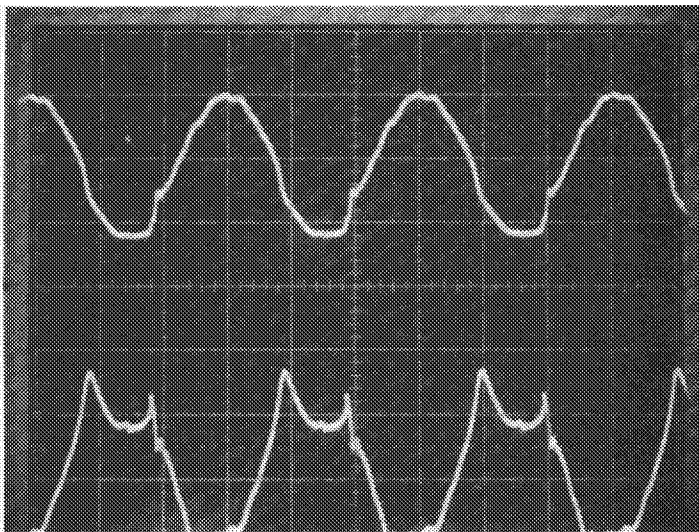

EHT SUPPLY  
 COLLECTOR OF  
 Q903  
 "0" DC 20 v/cm V  
 10 us/cm H

BASE OF  
 Q903  
 "0" DC 5 v/cm V  
 10 us/cm H

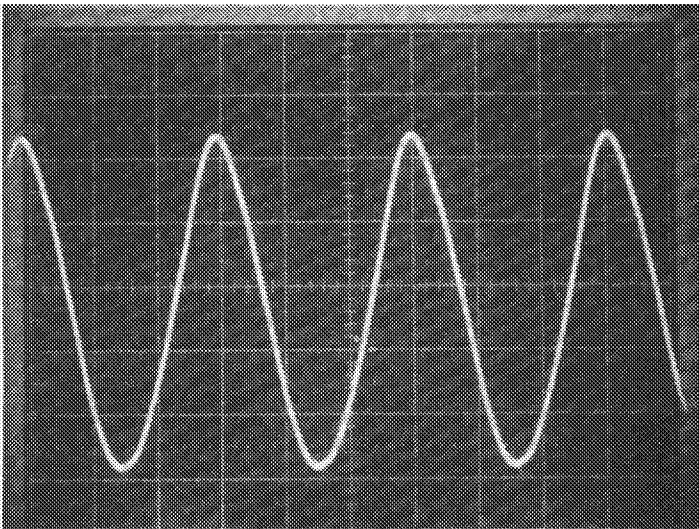

Scope Probe  
 loosely coupled to HI-VOLTAGE  
 TRANSFORMER  
 5 v/cm V  
 10 us/cm H

**MEMO**

### DEFLECTION P. C. B. SCHEMATIC NO.

X	R704	15"	750R	19"	820R
Y	R604	15"	750R	19"	910R

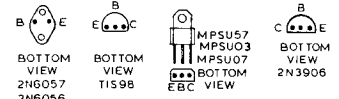
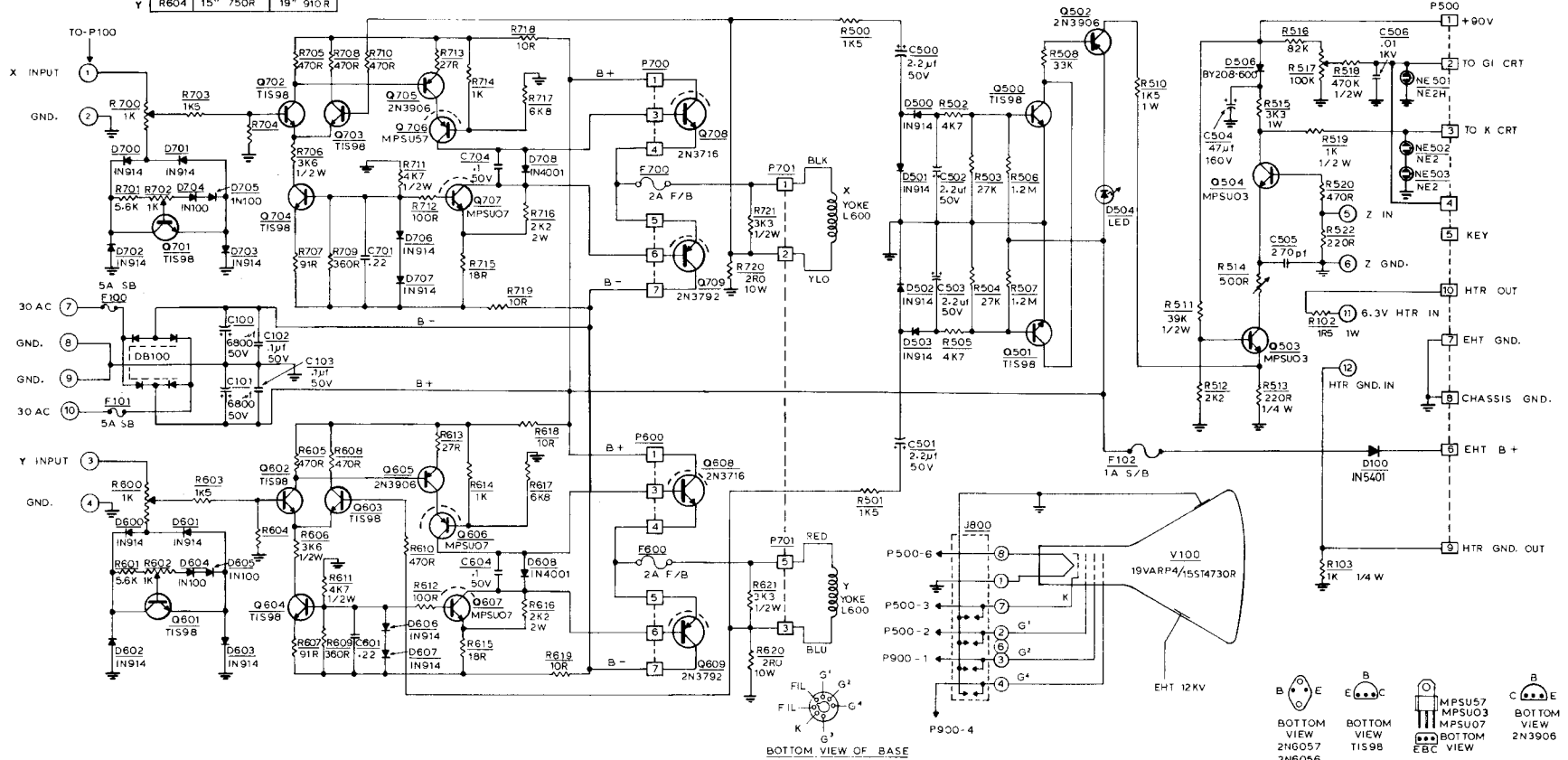

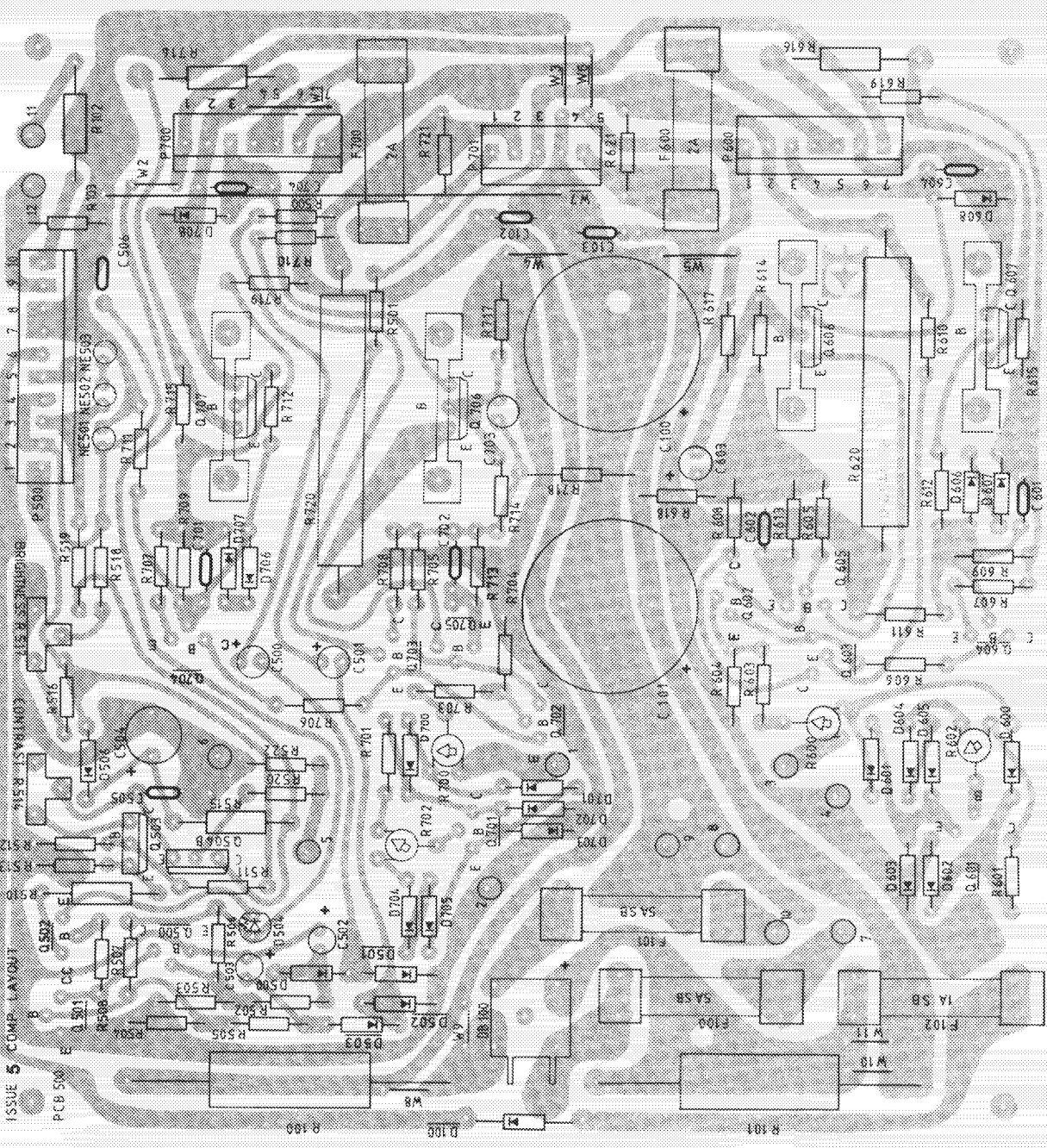

ISSUE 5 COMP LAYOUT  
PCB 500

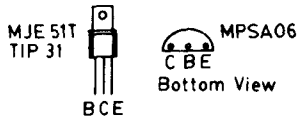
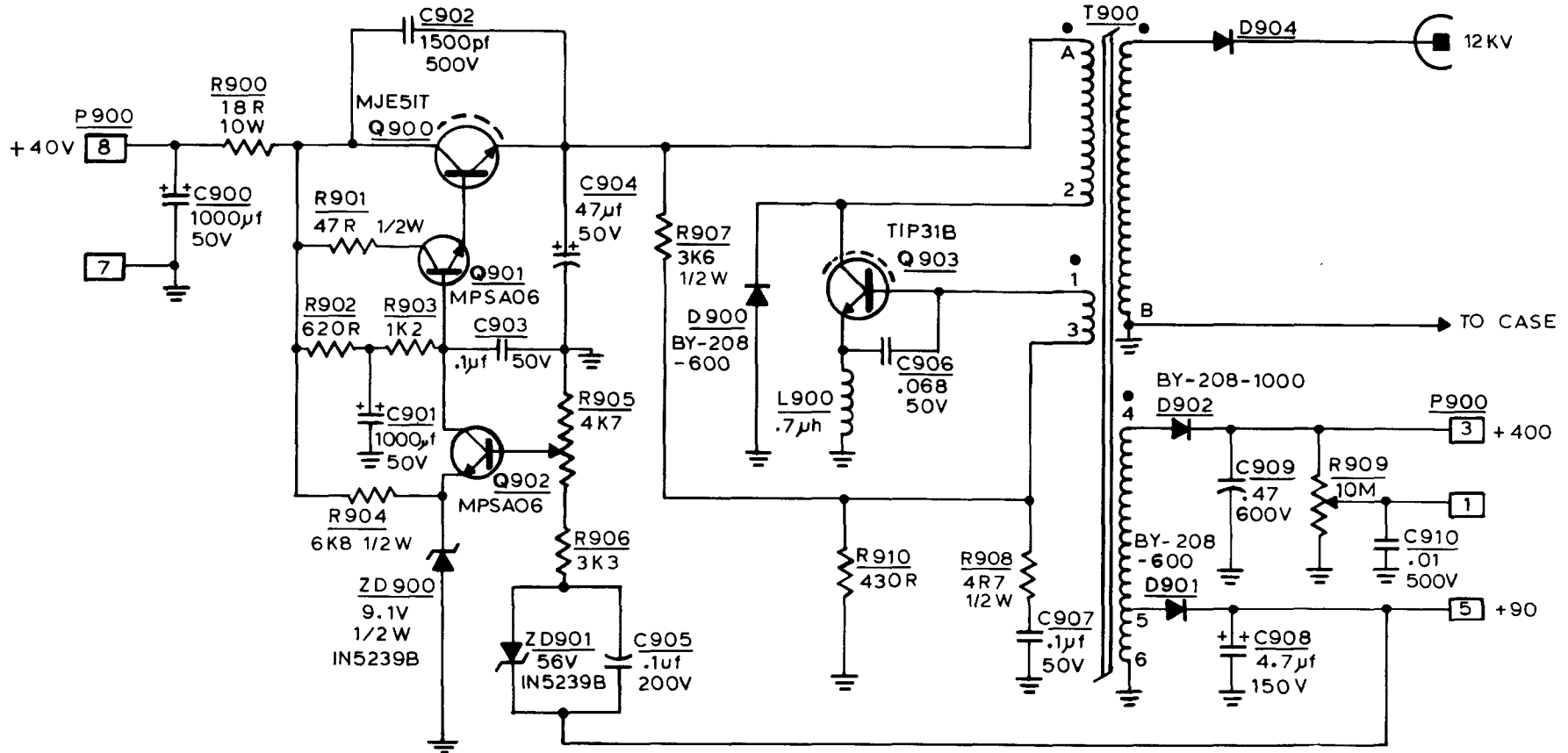



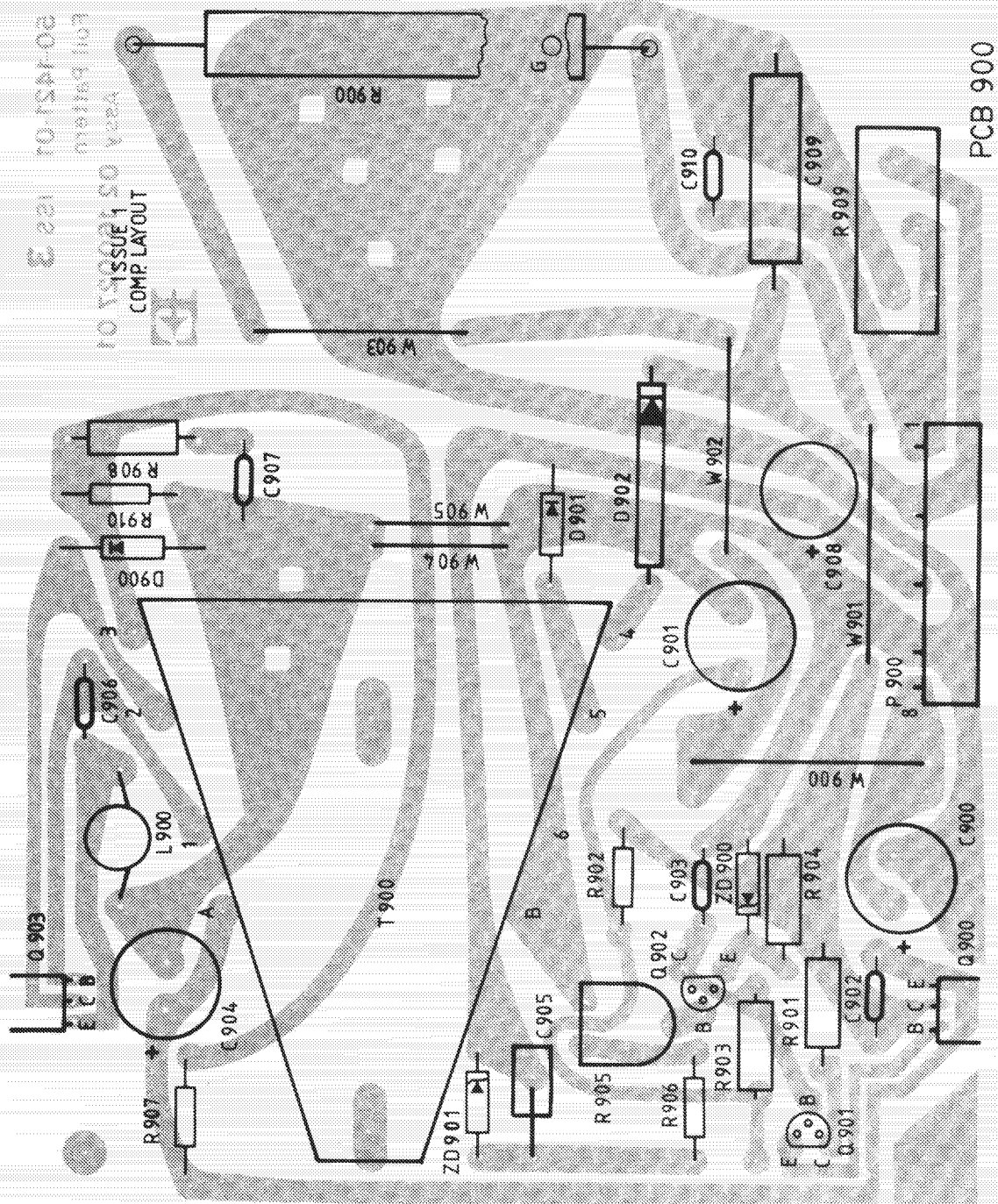

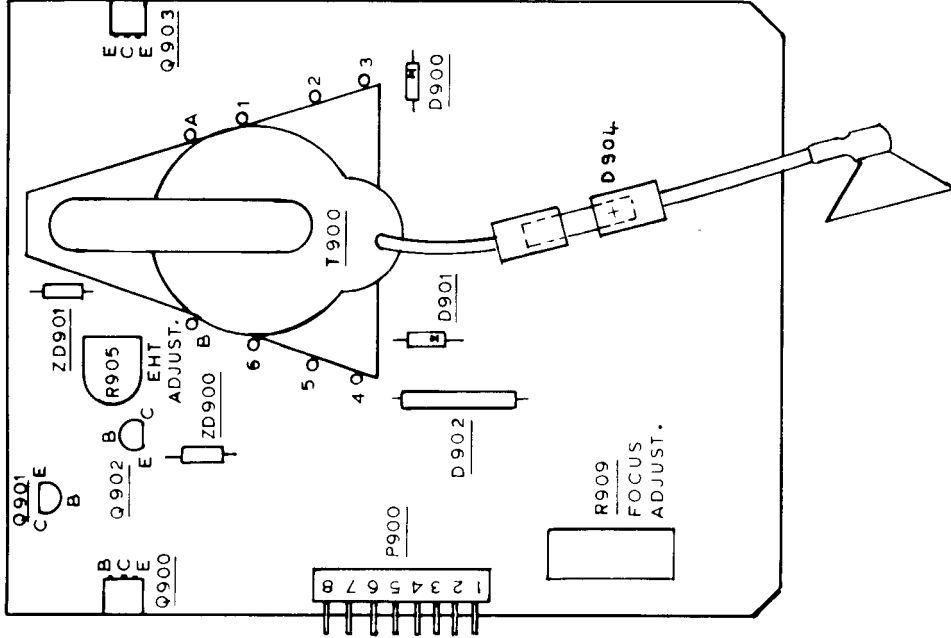
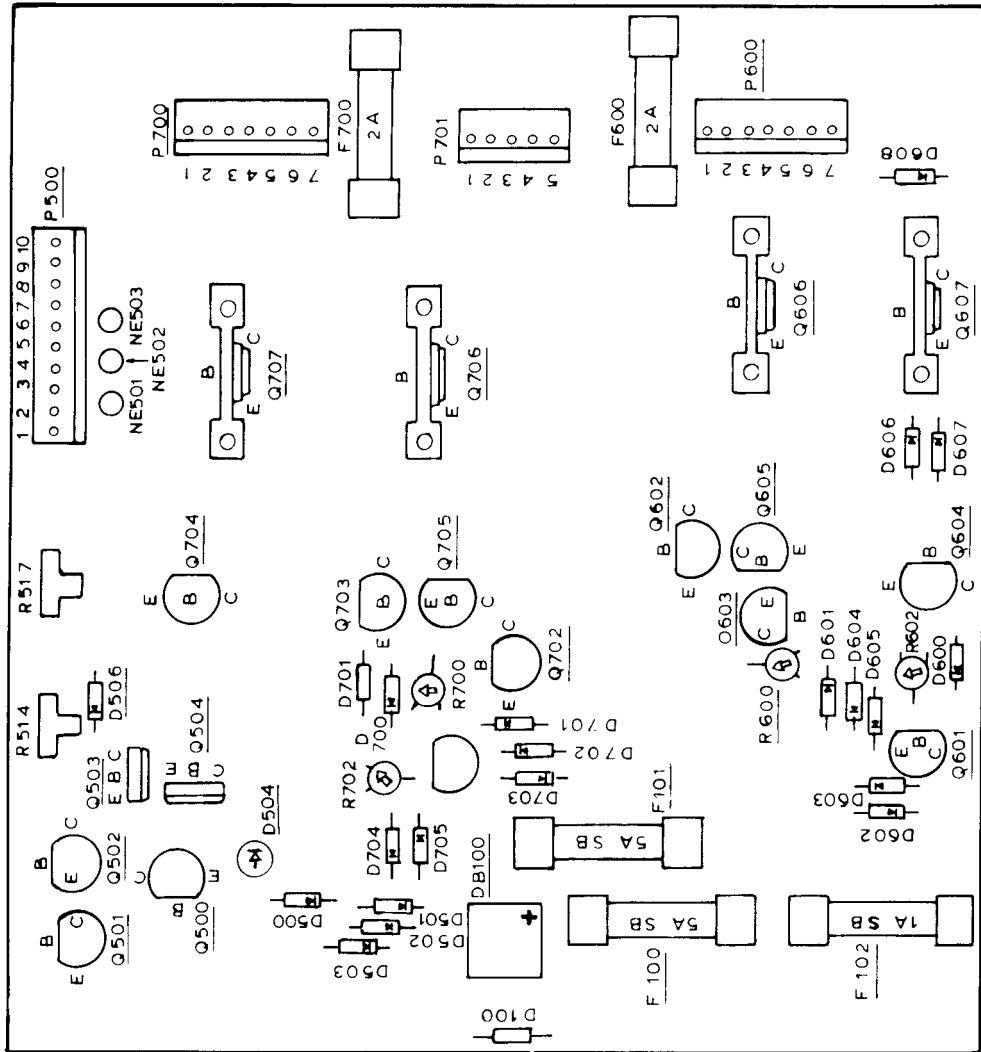

DEFLECTION AMPLIFIER P.C.B. NO. 50-1423-01

EHT SUPPLY P.C.B. NO. 50-1421-01

**NOTE :** ONLY THE BRIGHTNESS CONTROL (R517) AND THE CONTRAST CONTROL (R514) ON THE DEFLECTION AMPLIFIER PCB ARE "FIELD ADJUSTABLE". ALL OTHER CONTROLS, INCLUDING X AND Y LINEARITY, FOCUS, AND HIGH VOLTAGE, HAVE BEEN FACTORY ADJUSTED AND SHOULD **NOT** BE TAMPERED WITH.



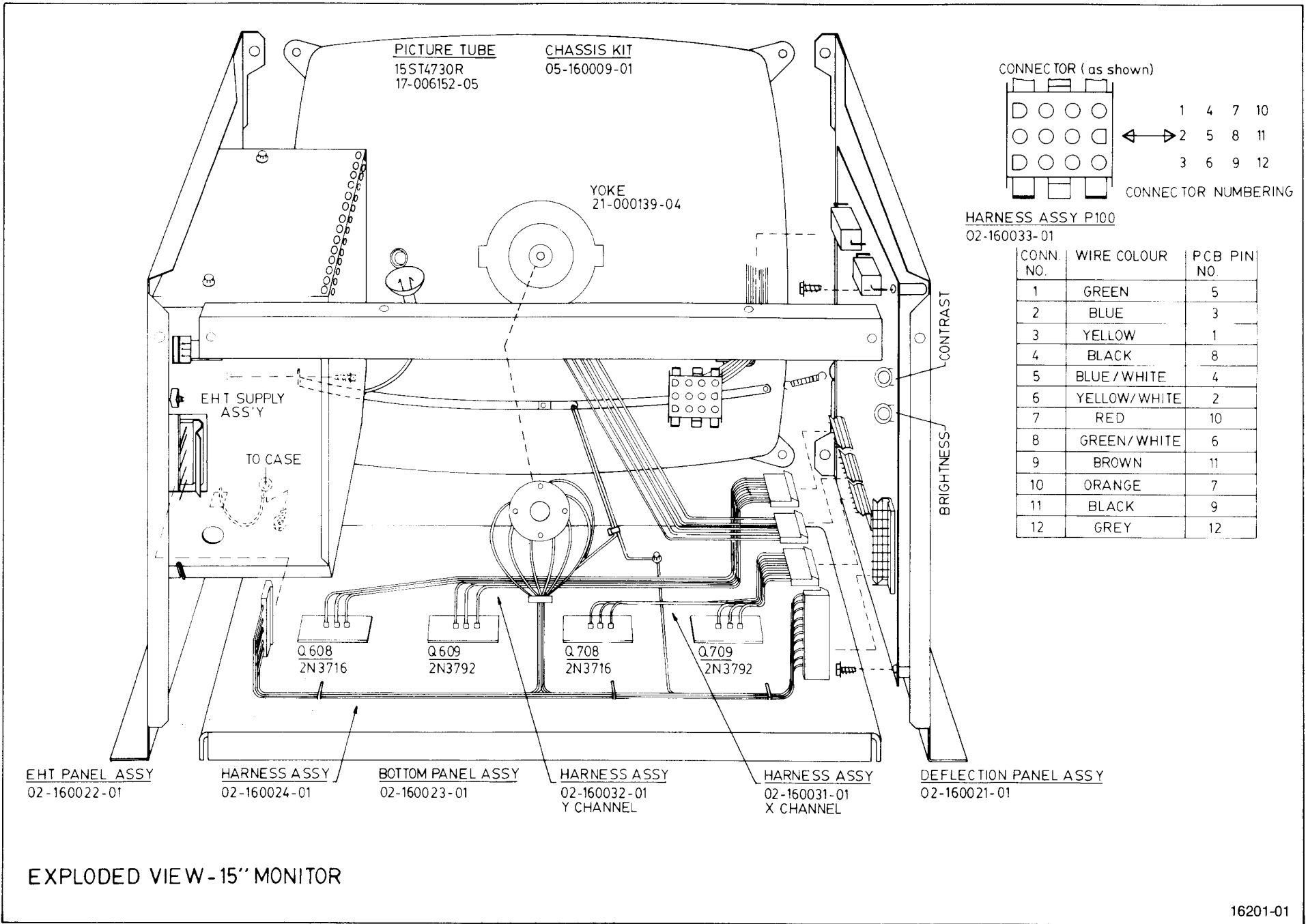

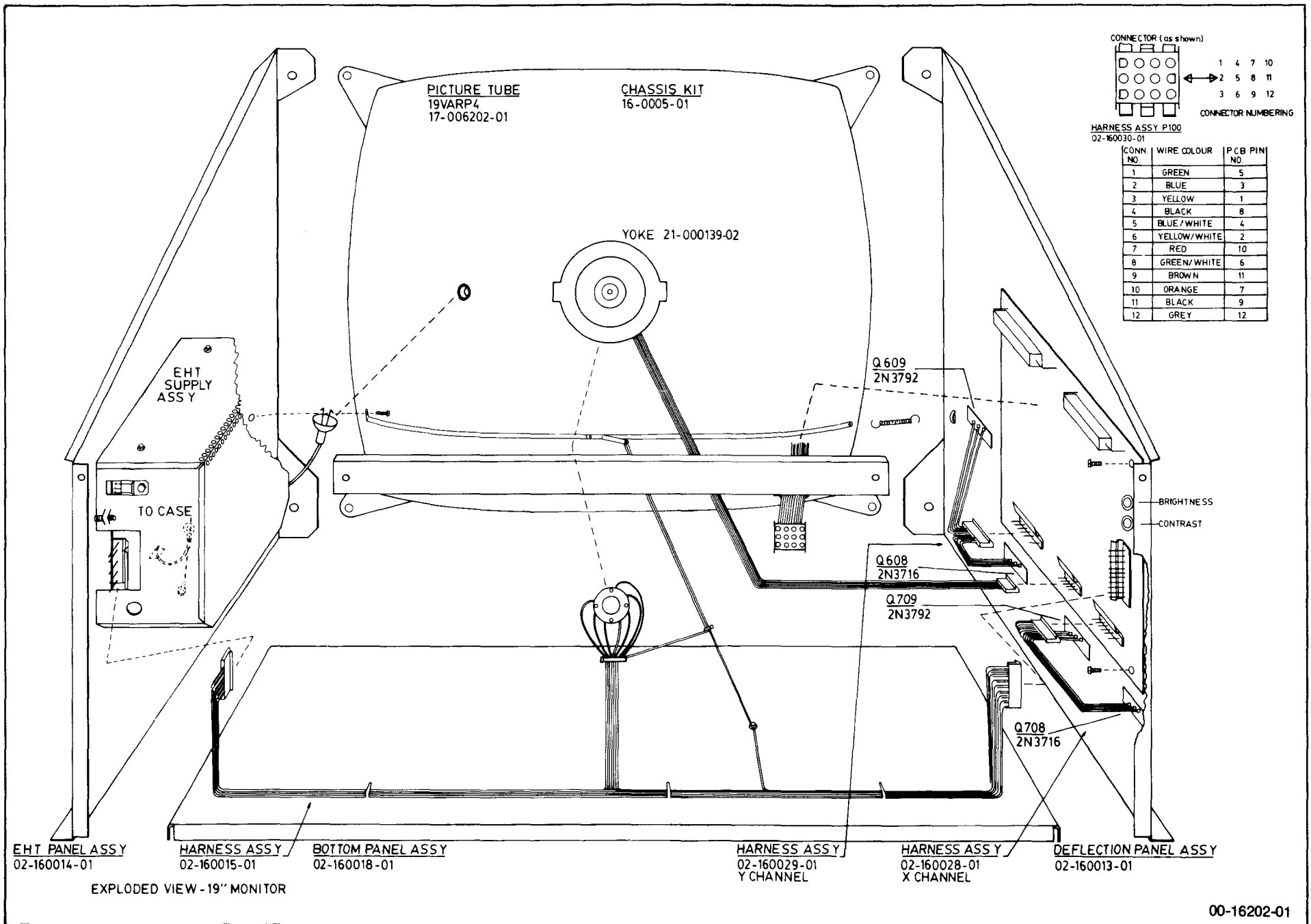

## INDEX FOR SERVICE REPLACEMENT PARTS LIST

<b>Assembly Description</b>	<b>Page No.</b>
Deflection Amp PCB G05-802 02-160026-01 .....	18
Deflection Panel Assembly G05-802 02-160013-01 .....	21
EHT Supply PCB G05-802/805 02-160016-01 .....	21
EHT Supply Assembly Kit G05-802/805 05-160006-01 .....	21
EHT Supply Panel Assembly G05-802 02-160014-01 .....	20
Bottom Panel Assembly G05-802 02-160018-01 .....	20
Chassis Kit G05-802 05-160006-01 .....	20
CRT Harness Assembly G05-802 02-160015-01 .....	20
Harness Assembly X Channel G05-802 02-160028-01 G05-805 02-160031-01 .....	23
Harness Assembly Y Channel G05-802 02-160029-01 G05-805 02-160032-01 .....	23
Harness Assembly P100 G05-802 02-160030-01 G05-805 02-160033-01 .....	23
Deflection Amp PCB G05-805 02-160025-01 .....	23
Deflection Panel Assembly G05-805 02-160021-01 .....	23
EHT Supply Panel Assembly G05-805 02-160022-01 .....	23
Bottom Panel Assembly G05-805 02-160023-01 .....	24
Chassis Kit G05-805 05-160009-01 .....	24
CRT Harness Assembly G05-805 02-160024-01 .....	24

## SERVICE REPLACEMENT PARTS LIST

### Deflection Amp PCB Assembly 02-160026-01 (G05-802) (19")

Comp. Name	Symbol	Description	Elect. P/N	House or JEDEC P/N	Remarks	
Capacitor	C100	6800uF 50V Elect.	44-568205-06			
	C101	6800uF 50V Elect.	44-568205-06			
	C102	.1uF 50V	46-310468-65			
	C103	.1uF 50V	46-310468-65			
	C500	2.2uF 50V Elect.	44-322506-01			
	C501	2.2uF 50V Elect.	44-322506-01			
	C502	2.2uF 50V Elect.	44-322506-01			
	C503	2.2uF 50V Elect.	44-322506-01			
	C504	47uF 160V Elect.	44-347009-08			
	C505	270pF 10% 500V	46-327113-51			
	C506	.01uF 1KV	46-510371-75			
	C601	.22uF 50V	49-32-01			
	C604	.1uF 50V	46-310468-65			
	C701	.22uF 50V	49-32-01			
	C704	.1uF 50V	46-310468-65			
	Resistor	R102	1R5 1w 5%	40-521595-04		
		R103	1K0 ¼w 5%	40-121025-31		
		R500	1K5 ¼w 5%	40-121525-31		
		R501	1K5 ¼w 5%	40-121-525-31		
		R502	4K7 ¼w 5%	40-124725-31		
R503		27K ¼w 5%	40-122735-31			
R504		27K ¼w 5%	40-122735-31			
R505		4K7 ¼w 5%	40-124725-31			
R506		1M2 ¼w 5%	40-121255-31			
R507		1M2 ¼w 5%	40-121255-31			
R508		33K ¼w 5%	40-123335-31			
R510		1K5 1w 5%	40-421525-31			
R511		39K ½w 5%	40-223935-31			
R512		2K2 ¼w 5%	40-122225-31			
R513		220R ¼w 5%	40-122215-31			
R514		500R Trim Pot	41-299-17		Contrast	
R515		3K3 1w 5%	40-423325-01			
R516		82K ¼w 5%	40-128235-31			
R517		100K Trim Pot	41-299-19		Brightness	
R518		470K ½w 5%	40-224745-31			
R519		1K0 ½w 5%	40-221025-31			
R520		470R ¼w 5%	40-124715-31			
R522	220R ¼w 5%	40-122215-31				
Resistor	R600	1K0 Trim Pot	41-331-02		Linarity Adjust	
	R601	5K6 ¼w 5%	40-125625-31			
	R602	1K0 Trim Pot	41-331-02		Linarity Adjust	
	R603	1K5 ¼w 5%	40-121525-31			
	R604	910R ¼w 5%	40-129115-11		G05-802	
	R605	470R ¼w 5%	40-124715-31			
	R606	3K6 ½w 5%	40-223625-31			
	R607	91R ¼w 5%	40-129105-31			
	R608	470R ¼w 5%	40-124715-31			
	R609	360R ¼w 5%	40-123615-31			
	R610	470R ¼w 5%	40-124715-31			
	R611	4K7 ½w 5%	40-224725-31			

**Deflection Amp PCB Assembly 02-160026-01 (G05-802) (19'') (continued)**

Comp. Name	Symbol	Description	Elect. P/N	House or JEDEC P/N	Remarks
	R612	100R ¼w 5%	40-121015-31		
	R613	27R ¼w 5%	40-122705-31		
	R614	1K0 ¼w 5%	40-121025-31		
	R615	18R ¼w 5%	40-121805-31		
	R616	2K2 2w 5%	40-622225-31		Carbon
	R617	6K8 ¼w 5%	40-126825-31		
	R618	10R ¼w 5%	40-121005-31		
	R619	10R ¼w 5%	40-121005-31		
	R620	2R0 7w 5%	42-122075-03		Wire wound
	R621	3K3 ½w 5%	40-223325-31		
Resistor	R700	1K0 Trim Pot	41-331-02		Linearity Adjust
	R701	5K6 ¼w 5%	40-125625-31		
	R702	1K0 Trim Pot	41-331-02		Linearity Adjust
	R703	1K5 ¼w 5%	40-121525-31		
	R704	820R ¼w 5%	40-128215-11		G05-802
	R705	470R ¼w 5%	40-124715-31		
	R706	3K6 ½w 5%	40-223625-31		
	R707	91R ¼w 5%	40-129105-31		
	R708	470R ¼w 5%	40-124715-31		
	R709	360R ¼w 5%	40-123615-31		
	R710	470R ¼w 5%	40-124715-31		
	R711	4K7 ½w 5%	40-224725-31		
	R712	100R ¼w 5%	40-121015-31		
	R713	27R ¼w 5%	40-122705-31		
	R714	1K0 ¼w 5%	40-121025-31		
	R715	18R ¼w 5%	40-121805-31		
	R716	2K2 2w 5%	40-622225-31		
	R717	6K8 ¼w 5%	40-126825-31		
	R718	10R ¼w 5%	40-121005-31		
	R719	10R ¼w 5%	40-121005-31		
	R720	2R0 7w 5%	42-122075-03		
	R721	3K3 ½w 5%	40-223325-31		
Semiconductors	D100	Diode 3A 100PIV	14-514-44	IN5401	TI
	D500	Diode Signal	14-514-42	IN914	TI
	D501	Diode Signal	14-514-42	IN914	TI
	D502	Diode Signal	14-514-42	IN914	TI
	D503	Diode Signal	14-514-42	IN914	TI
	D504	LED RED	14-521-03		Jumbo
	D506	Diode 1A 600PIV	28-44-02	BY-208-600	Philips
	D600	Diode Signal	14-514-42	IN914	TI
	D601	Diode Signal	14-514-42	IN914	TI
	D602	Diode Signal	14-514-42	IN914	TI
	D603	Diode Signal	14-514-42	IN914	TI
	D604	Diode Signal	14-514-43	IN100	TI
	D605	Diode Signal	14-514-43	IN100	TI
	D606	Diode Signal	14-514-42	IN914	TI
	D607	Diode Signal	14-514-42	IN914	TI
	D608	Diode Signal	14-525-02	IN4001	TI
Semiconductors	D700	Diode Signal	14-514-42	IN914	TI
	D701	Diode Signal	14-514-42	IN914	TI
	D702	Diode Signal	14-514-42	IN914	TI
	D703	Diode Signal	14-514-42	IN914	TI
	D704	Diode Signal	14-514-43	IN100	TI
	D705	Diode Signal	14-514-43	IN100	TI
	D706	Diode Signal	14-514-42	IN914	TI
	D707	Diode Signal	14-514-42	IN914	TI
	D708	Diode Signal	14-525-02	IN4001	TI
	DB100	Bridge Rectifier	28-46-02	KBPC602	GI

**Deflection Amp PCB Assembly 02-160026-01 (G05-802) (19") (continued)**

Comp. Name	Symbol	Description	Elect. P/N	House or JEDEC P/N	Remarks
	Q500	Transistor	14-943-12	TIS98	
	Q501	Transistor	14-943-12	TIS98	
	Q502	Transistor	14-873-32	2N3906	
	Q503	Transistor	14-944-12	MPSU03	Alternate 14-965-12
	Q504	Transistor	14-944-12	MPSU03	Alternate 14-965-12
	Q601	Transistor	14-943-12	TIS98	Alternate 14-943-32
	Q602	Transistor	14-943-12	TIS98	Alternate 14-943-32
	Q603	Transistor	14-943-12	TIS98	Alternate 14-943-32
	Q604	Transistor	14-943-12	TIS98	Alternate 14-943-32
	Q605	Transistor	14-873-32	2N3906	
	Q606	Transistor	14-934-12	MPSU57	Alternate 14-961-03
	Q607	Transistor	14-935-12	MPSU07	Alternate 14-962-01
	Q701	Transistor	14-943-12	TIS98	Alternate 14-943-32
	Q702	Transistor	14-943-12	TIS98	Alternate 14-943-32
	Q703	Transistor	14-943-12	TIS98	Alternate 14-943-32
	Q704	Transistor	14-943-12	TIS98	Alternate 14-943-32
	Q705	Transistor	14-873-32	2N3906	
	Q706	Transistor	14-934-12	MPSU57	Alternate 14-961-03
	Q707	Transistor	14-935-12	MPSU07	Alternate 14-962-01
Lamps and Fuses	F100	Fuse 5A 250V	27-5-07		SLO-BLO
	F101	Fuse 5A 250V	27-5-07		SLO-BLO
	F102	Fuse 1A 250V	27-5-02		SLO-BLO
	F600	Fuse 2A 250V	27-14-19		Fast Acting
	F700	Fuse 2A 250V	27-14-19		Fast Acting
	NE501	Neon Lamp	27-11-10	NE2H	
	NE502	Neon Lamp	27-11-05	NE2	
	NE503	Neon Lamp	27-11-05	NE2	
Hardware	SC	#4 - 1/2 Mach. Screw	31-600418-06		Trans. to H. Sink
	SC	#6 - 3/8 Mach. Screw	31-600618-10		DB100 Heat Sink
	SC	#4 - 1/2 Self Tap Screw	31-610418-06		H. Sink to PCB
	NU	#440 Nut	33-30-07		Trans. to H. Sink
	NU	#6 Nut	33-440-01		DB100 H. Sink
	CL	Fuse Clip	33-446-03		2 per fuse
	RY	Radio Pin	34-490-01		R100 MTG
	P500	10 Pin connector	34-621-21	MOLEX	PCB Mounted
	P600	7 Pin Connector	34-621-07	MOLEX	PCB Mounted
	P700	7 Pin Connector	34-621-07	MOLEX	PCB Mounted
	P701	5 Pin Connector	34-621-05	MOLEX	PCB Mounted
	BR	Heat Sink	35-3702-01		DB100
	BR	Heat Sink	35-4017-02		Q706, Q707
PC Board	PB	Defl. AMP PCB	50-1423-01		Board only

**DEFLECTION PANEL ASSEMBLY 02-160013-01 (G05-802) (19")**

Comp. Name	Symbol	Description	Elect. P/N	House or JEDEC P/N	Remarks
Semiconductor	Q607	Transistor	14-940-01	2N3792	
	Q608	Transistor	14-941-01	2N3716	
	Q707	Transistor	14-940-01	2N3792	
	Q708	Transistor	14-941-01	2N3716	
Hardware	BR	LH Side Panel	35-3991-01		
		Clip PCB Support	33-629-02		Spring Steel (3)
		Nylon Spacer	32-81-01		PCB Mount (2)
		Support Spacer	33-708-04		Nylon (3)
	SC	#8 - 7/8 Self Tap Screw	31-620818-14		PCB Mount
	SC	#6 - 1/2 Self Tap Screw	31-620618-08		Transistor Mount.

**DEFLECTION PANEL ASSEMBLY 02-160013-01 (G05-802) (19") (continued)**

Comp. Name	Symbol	Description	Elect. P/N	House or JEDEC P/N	Remarks
	QS	Output Trans. Socket	34-515-03		T03 Socket
	SH	Output Trans. Insulator	39-68-16		MICA 3 thou
	LA	Fuse Caution Label	54-8399-01		

**EHT SUPPLY PCB ASSEMBLY 02-160016-01 (G05-802) and (G05-805)**

Comp. Name	Symbol	Description	Elect. P/N	House or JEDEC P/N	Remarks
Capacitor	C900	1000uF 50V	44-410206-10		
	C901	1000uF 50V	44-410206-10		
	C902	1500pF 500V	46-315217-07		
	C903	.1uF 50V	46-310468-65		
	C904	47uF 50V	44-347006-25		
	C905	.1uF 200V	49-33-01		
	C906	.22uF 50V	48-172242-42		
	C907	.1uF 50V	46-310468-65		
	C908	4.7uF 150V	44-347509-25		
	C909	.47uF 600V	48-174746-62		
C910	.01uF 1000V	46-510371-75			
Resistor	R900	18R 10w 5%	42-141805-03		Wire wound
	R901	47R 1/2w 5%	40-224705-11		
	R902	620R 1/4w 5%	40-126215-11		
	R903	1K2 1/4w 5%	40-121225-11		
	R904	6K8 1/2w 5%	40-226825-11		
	R905	4K7 Trim Pot	41-265-12		EHT Adjust
	R906	3K3 1/4w 5%	40-123325-11		
	R907	3K6 1/2w 5%	40-223625-11		
	R908	4R7 1/2w 5%	40-224795-11		
	R909	10M Pot	41-227-72		Focus Adjust
R910	430R 1/4w 5%	40-124315-11			
Semiconductor	D900	Fast Recovery Diode	28-44-02	BY-208-600	Philips
	D901	Fast Recovery Diode	28-44-02	BY-208-600	Philips
	D902	Fast Recovery Diode	28-44-02	BY-208-1000	Philips
	ZD900	9.1V 1/2w Zener 5%	14-515-67	IN5239B	
	ZD901	56V 1/2w Zener 5%	14-515-84	IN5263B	
	Q901	Transistor	14-936-32	MPSA06	
Q902	Transistor	14-936-32	MPSA06		
Inductor	L900	.7uH coil	21-1126-01		
	T900	EHT Transformer	24-180001-02		
Hardware	NU	Hex Nut 4-40	33-9-01		T900 MTG (2)
	WA	Lockwasher #4	33-24-05		T900 MTG (2)
	RV	Radio Pin	34-490-01		R900 Support (2)
	P900	8 Pin Connector	34-557-08		PCB Mounted
	SQ901	T0220 Trans. Socket	34-594-02		Q900
	SQ902	T0220 Trans. Socket Eyelet	34-594-02 34-699-01		Q903 C909 Support (2) GND Wire Support
PC Board	PC	EHT PCB	50-1421-01		Board Only

**EHT SUPPLY ASSEMBLY KIT 05-160006-01 (G05-802) and (G05-805)**

Comp. Name	Symbol	Description	Elect. P/N	House or JEDEC P/N	Remarks
Semiconductor	Q900	Transistor	14-942-23	MJE51T	Mot.
	Q903	Transistor	14-937-23	TIP31B	Mot.
	D904	EHT Rectifier	28-42-01		Alternate 28-48-01
	SC	#4 - 3/8 Self Tap Screw	31-610418-06		T0220 MTG
	SC	#8 - 3/8 Self Tap Screw	31-610818-06		Shield, Gnd. Wire
	RV	Rubber Gromet	32-44-04		Shield

**EHT SUPPLY ASSEMBLY KIT 05-16006-01 (G05-802) and (G05-805) (continued)**

Comp. Name	Symbol	Description	Elect. P/N	House or JEDEC P/N	Remarks
	WA	#8 Lockwasher	33-25-01		Gnd. Wire
		Ring Terminal	34-699-01		Gnd. Wire
		H.V. Connector and Lead	34-717-02 and -03		Anode CRT
		EHT Heatsink Wrap	35-4018-01		
	BR	EHT Cover Shield	35-4019-01		
	SH	Insulator	39-68-15		T0220 MTG
	WA	Shoulder Washer	39-1189-01		T0220 MTG
	NU	Anode Bushing	39-1248-01		Nylon
	NU	Anode Bushing Nut	39-1248-02		Nylon
	LA	Focus Adjust Label	54-8490-01		On Wrap
	LA	EHT Adjust Label	54-8491-01		On Cover
	LA	EHT Warning Label	54-8597-01		On Wrap

**EHT SUPPLY PANEL ASSEMBLY 02-160014-01 (G05-802) (19")**

Comp. Name	Symbol	Description	Elect. P/N	House or JEDEC P/N	Remarks
Hardware	SC	Screw #8 - 7/8	31-620818-14		Wrap to Panel
		Cable Tie	33-523-04		Nylon Clamp
	WA	Lockwasher #8	33-25-01		For #8 Screw (3)
	BR	Panel RHS	35-3990-01		
	LA	Warning Label	54-8198-02		Vacuum Caution

**BOTTOM PANEL ASSEMBLY 02-160018-01 (G05-802) (19")**

Comp. Name	Symbol	Description	Elect. P/N	House or JEDEC P/N	Remarks
Hardware	SC	Screw #8 - 3/8	31-610818-06		Gnd. Wires
	SC	Screw #8 - 7/8	31-620818-14		BOTTO Side MTG (4)
	WA	Washer #8	33-25-01		
	WA	Washer .468 x .187	33-210-50		P100 MTG
	CL	Cable Clamp	33-451-06		P100 MTG
		Cable Tie	33-523-04		Wire Harness
	BR	Chassis Base	38-454-01		Bottom Plate

**CHASSIS KIT 05-160005-01 (G05-802) (19")**

Comp. Name	Symbol	Description	Elect. P/N	House or JEDEC P/N	Remarks
Inductors	L600	Yoke	21-139-02		10" Leads
Hardware	SC	Screw #8 - 3/8	31-610818-06		Gnd. Strap
	WA	Lockwasher	33-255-01		CRT MTG
	SC	Screw	33-585-42		CRT MTG
	W	Gnd. Strap Assy.	34-697-02		
	SS	Spring	35-3560-01		Gnd. Strap
	LA	Label Part No.	54-8546-03		Customer ID
CRT	V100	Picture Tube	17-6202-01	19VARP4	Sylvania

**CRT HARNESS ASSEMBLY 02-160015-01 (G05-802) (19")**

Comp. Name	Symbol	Description	Elect. P/N	House or JEDEC P/N	Remarks
Hardware	J500	10 Pin Connector	34-655-10	MOLEX	Female
	J800	CRT Socket	34-213-15		
		Crimp Terminals	34-550-01	MOLEX	J500, J900
	J900	8 Pin Connector	34-655-08	MOLEX	Female
		Cable Tie	33-523-01		Harness
		Ring Terminal	34-699-01		P500-8/Gnd. Strap
		Polarizing Key	34-552-01	MOLEX	J500, J900



**HARNES ASSEMBLY X CHANNEL 02-160028-01 (G05-802) (19")**  
**02-160031-01 (G05-805) (15")**

Comp. Name	Symbol	Description	Elect. P/N	House or JEDEC P/N	Remarks
Hardware		Cable Tie	33-523-06		Nylon
		Crimp Terminal	34-550-01	MOLEX	J700
		Polarizing Key	34-552-01	MOLEX	J700
	J700	7 Pin Connector	34-655-07	MOLEX	

**HARNES ASSEMBLY Y CHANNEL 02-160029-01 (G05-802) (19")**  
**02-160032-01 (G05-805) (15")**

Comp. Name	Symbol	Description	Elect. P/N	House or JEDEC P/N	Remarks
Hardware		Cable Tie	33-523-06		Nylon
		Crimp Terminal	34-550-01	MOLEX	J600
		Polarizing Key	34-552-01	MOLEX	J600
	J600	7 Pin Connector	34-655-07	MOLEX	

**HARNES ASSEMBLY P100 02-160030-01 (G05-802) (19")**  
**02-160033-01 (G05-805) (15")**

Comp. Name	Symbol	Description	Elect. P/N	House or JEDEC P/N	Remarks
Hardware		Cable Tie	33-523-06		Nylon
		Pin Tip	34-676-01	AMP	PCB Mount (12)
	P100	12 Connector Receptacle	34-677-32	AMP	Fire Retardant

**DEFLECTION AMP PCB ASSEMBLY 02-160025-01 (G05-805) (15")**

Comp. Name	Symbol	Description	Elect. P/N	House or JEDEC P/N	Remarks
Resistor	R604	750R 1/4w 5%	40-127515-11		
	R704	750R 1/4w 5%	40-127515-11		

\*All other components identical to G05-802 Model. See Assembly 02-160026-01

**DEFLECTION PANEL ASSEMBLY 02-160021-01 (G05-805) (15")**

Comp. Name	Symbol	Description	Elect. P/N	House or JEDEC P/N	Remarks
Hardware	BR	Panel LHS	35-3969-01		
		PCB Support Clip	33-629-01		Spring Steel (2)
		PCB MTG Spacer	32-81-01		Nylon (2)
		PCB Support Spacer	33-708-04		Nylon (2)
	SC	Screw #8 - 7/8	31-620818-14		PCB Mounting (2)
	LA	ID Label, Control	54-8557-01		Brite, Contrast

**EHT SUPPLY PANEL ASSEMBLY 02-160022-01 (G05-805) (15")**

Comp. Name	Symbol	Description	Elect. P/N	House or JEDEC P/N	Remarks
Hardware	SC	Screw #8 - 7/8	31-620818-14		EHT Mount (3)
	BR	Panel RHS	35-3968-01		
	LA	Warning Label	54-8198-02		CRT Handeling

**CRT HARNESS ASSEMBLY 02-160024-01 (G05-805) (15")**

Comp. Name	Symbol	Description	Elect. P/N	House or JEDEC P/N	Remarks
Hardware	J800	CRT Socket	34-213-14		

\*All other components identical to G05-802 Model. See assembly 02-160015-01.

**BOTTOM PANEL ASSEMBLY 02-160023-01 (G05-805) (15")**

Comp. Name	Symbol	Description	Elect. P/N	House or JEDEC P/N	Remarks
Semiconductor	Q608	Transistor	14-941-01	2N3716	
	Q609	Transistor	14-940-01	2N3792	
	Q708	Transistor	14-941-01	2N3716	
	Q709	Transistor	14-940-01	2N3792	
Hardware	SC	Screw #8 - 3/8	31-610818-06		Side Pnl. MTG (4)
	SC	Screw #6 - 1/2	31-620618-08		Transistor MTG (8)
	WA	Lockwasher #8	33-25-01		Side Pnl. MTG (4)
	WA	Washer	33-210-50		For Cable Clamp
	CL	Cable Clamp	33-451-06		For P100
	QS	Transistor Socket	34-515-03		T03
	HS	Chassis Base Plate	38-453-01		
	SH	T03 Insulator	39-68-16		MICA 3 thou
	LA	Fuse Caution Label	54-8399-01		
	LA	Part No. Label	54-8546-01		Customer ID

**CHASSIS KIT 05-160009-01 (G05-805) (15")**

Comp. Name	Symbol	Description	Elect. P/N	House or JEDEC P/N	Remarks
Inductor	L600	Yoke	21-139-04		7" Leads
Hardware	SC	Screw	31-610818-04		
	SC	Screw	31-610818-06		Side Pnl. to Bottom
	SC	Screw #8-32 - 3/8	33-585-22		CRT MTG
	SC	Screw #6 - 3/8	31-610618-06		
	WA	Washer	33-210-50		
	WA	Lockwasher	33-20-03		CRT MTG
		Ring Terminal	34-699-01		Gnd. strap, P500-8
	SS	Spring	35-3560-01		Gnd. Strap
	BR	Bracket Back	35-3972-01		Top Rear Brace
	BR	Bracket Side	35-3973-01		Front Sides (2)
W	Ground Strap Assy.	34-697-03			
LA	Label Part No.	54-8546-02		Customer ID	
CRT	V100	Picture Tube	17-6152-05	15ST4730R	Sylvania

## **PARTS AND SERVICE LOCATIONS**

### **USA**

**ELECTROHOME (USA) Limited**  
250 Wales Avenue,  
Tonawanda, New York 14150  
Telephone: 1-716-694-3332  
Telex:

### **CANADA**

**AABEX Electronic Services**  
145 Idema Road,  
Markham, Ontario  
Canada L3R 1A9  
Telephone: 1-416-475-0313  
Telex: 06-986-819

**AABEX Electronic Services**  
3444 Lougheed Highway,  
Vancouver, British Columbia  
Canada V5M 2A5  
Telephone: 1-604-253-8421  
Telex: 045-1486

**Service Electrohome**  
370 Isabey St.  
Ville St-Laurent, Quebec  
Canada H4T 1W1  
Telephone: 1-514-731-2736  
Telex: 058-26588

**Service Electrohome**  
809 Wellington St. N.,  
Kitchener, Ontario  
Canada N2G 4J6  
Telephone: 1-519-579-7600

### **INTERNATIONAL**

**Service Electrohome**  
809 Wellington St. N.,  
Kitchener, Ontario  
Canada N2G 4J6  
Telephone: 1-519-744-7111, Ext. 441, 442, 443  
Telex: 069-55320